

Jaguar

1965-67 XK-E (4.2 Litre)

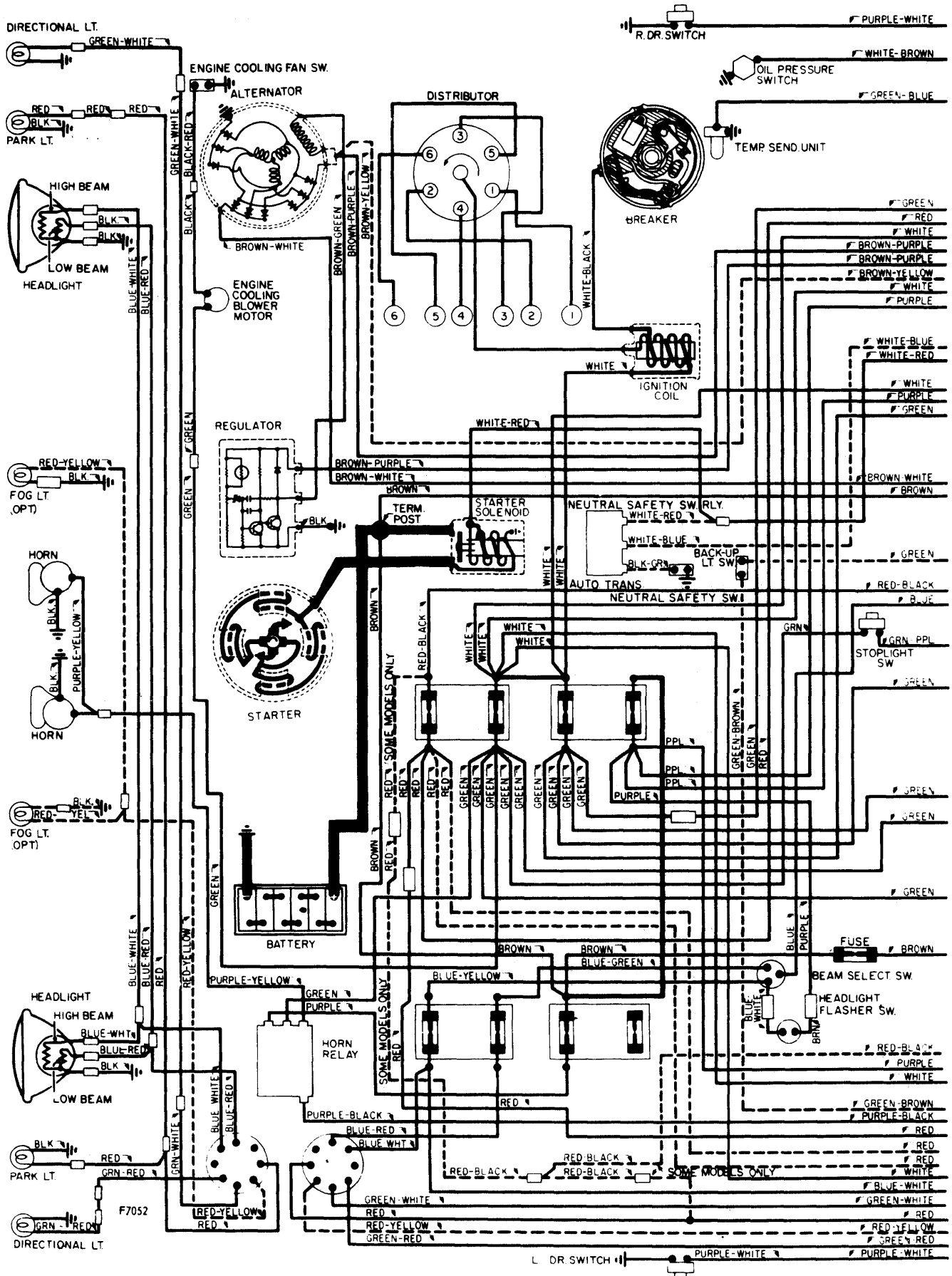

Jaguar

1968-70 XK-E (4.2 Litre)

