

1F9043

CHRYSLER CORP. DOOR LOCK WIRING DIAGRAM

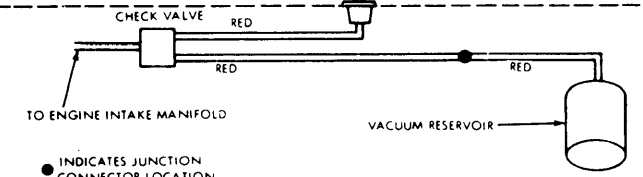

VACUUM DOOR LOCK SCHEMATIC (FORD, MERCURY & METEOR) CF9030

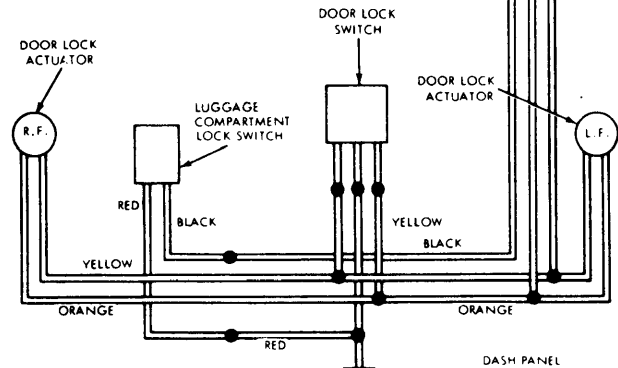
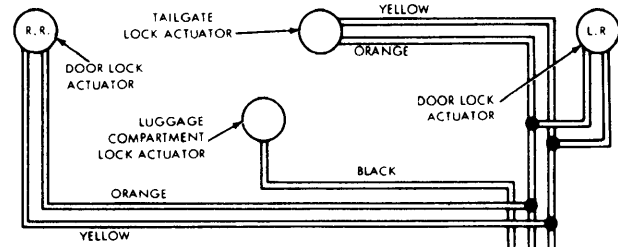
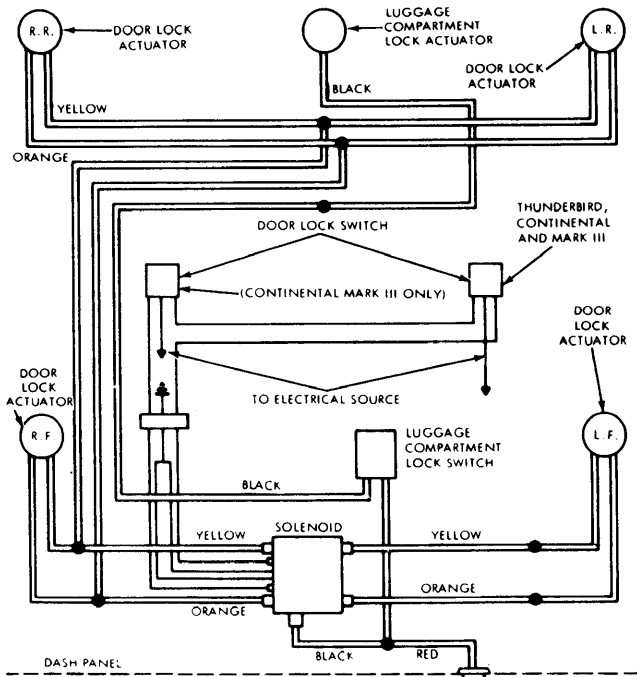
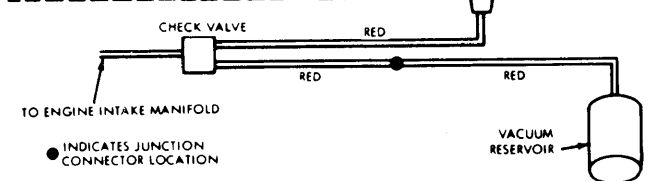
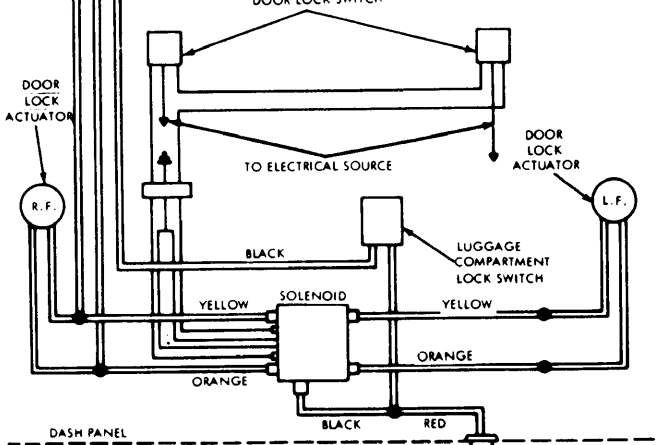
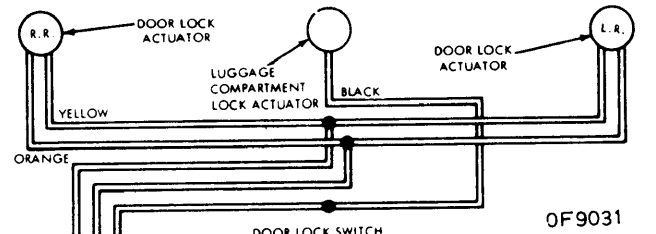

OF9032

VACUUM DOOR LOCK SCHEMATIC (CONTINENTAL MARK III & THUNDERBIRD)

VACUUM DOOR LOCK SCHEMATIC (LINCOLN CONTINENTAL)