

1974-79 EXHAUST EMISSION SYSTEMS

Volkswagen Vacuum Diagrams

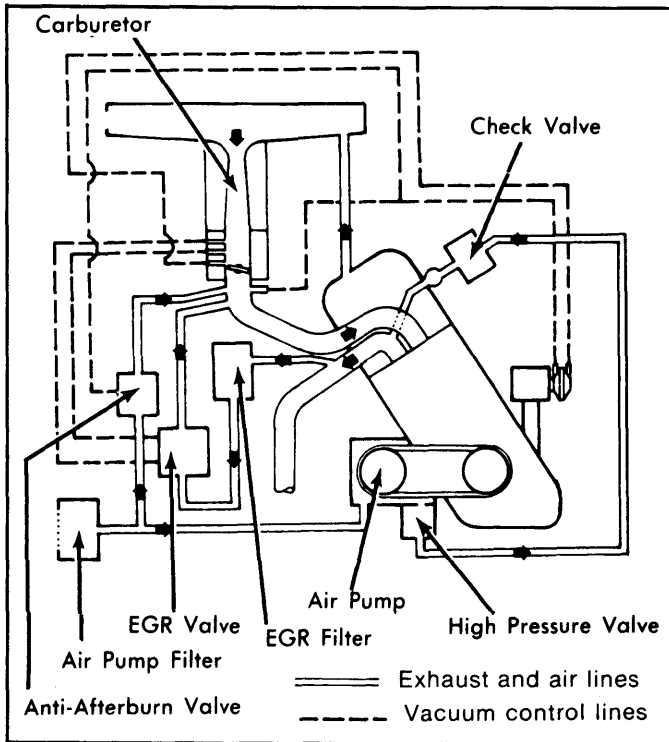

Fig. 1: 1974 Dasher Exhaust Emission System

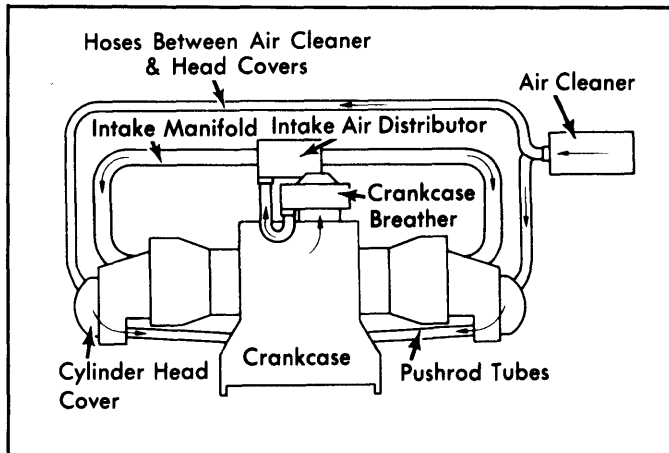

Fig. 2: 1974 Positive Crankcase Ventilation System (Fuel Injected)

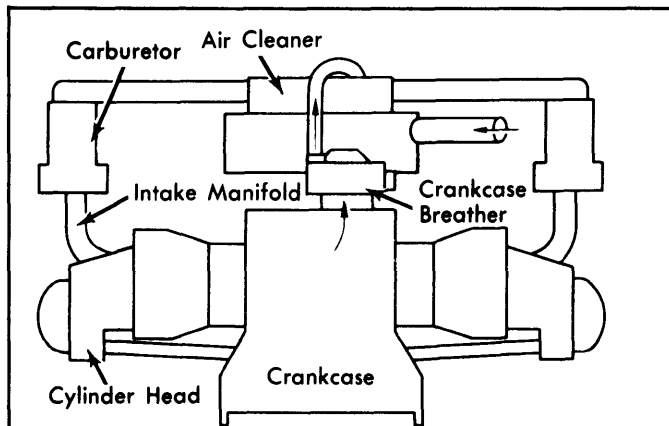

Fig. 3: 1974 Type 2 Positive Crankcase Ventilation System

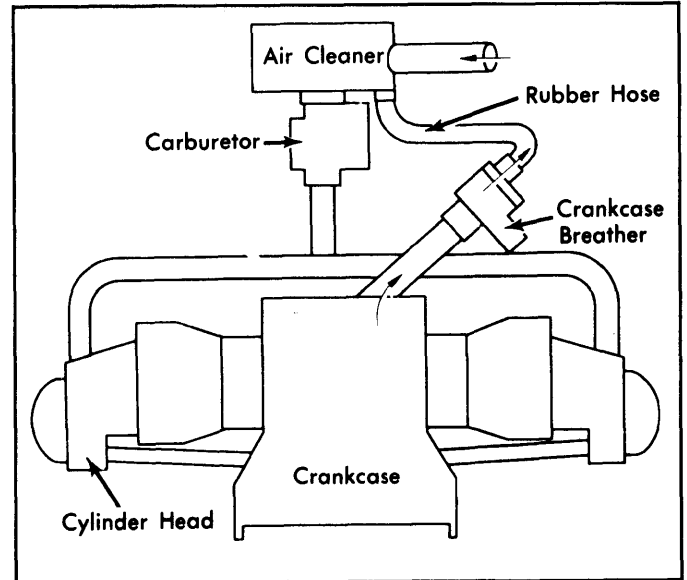

Fig. 4: 1974 Type 1, 4 & Thing Positive Crankcase Ventilation System

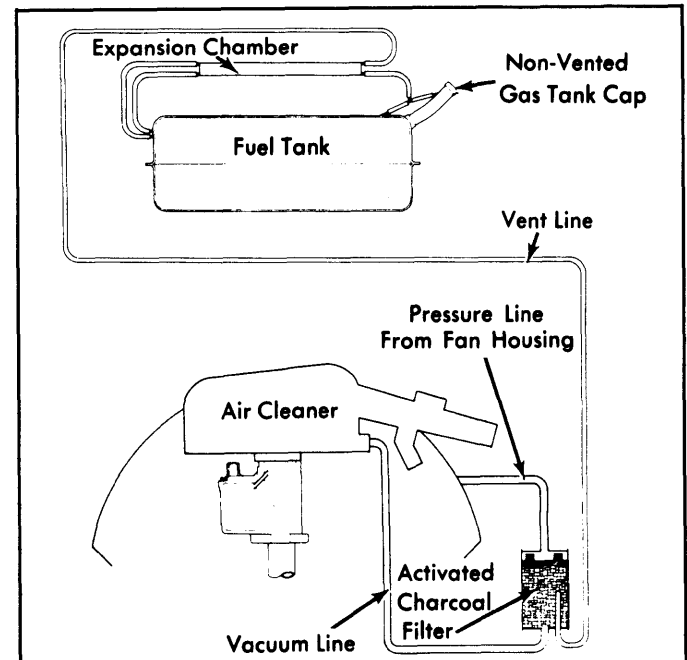

Fig. 5: 1974-75 Fuel Evaporation System (Except Dasher)

1974-79 EXHAUST EMISSION SYSTEMS Volkswagen Vacuum Diagrams (Cont.)

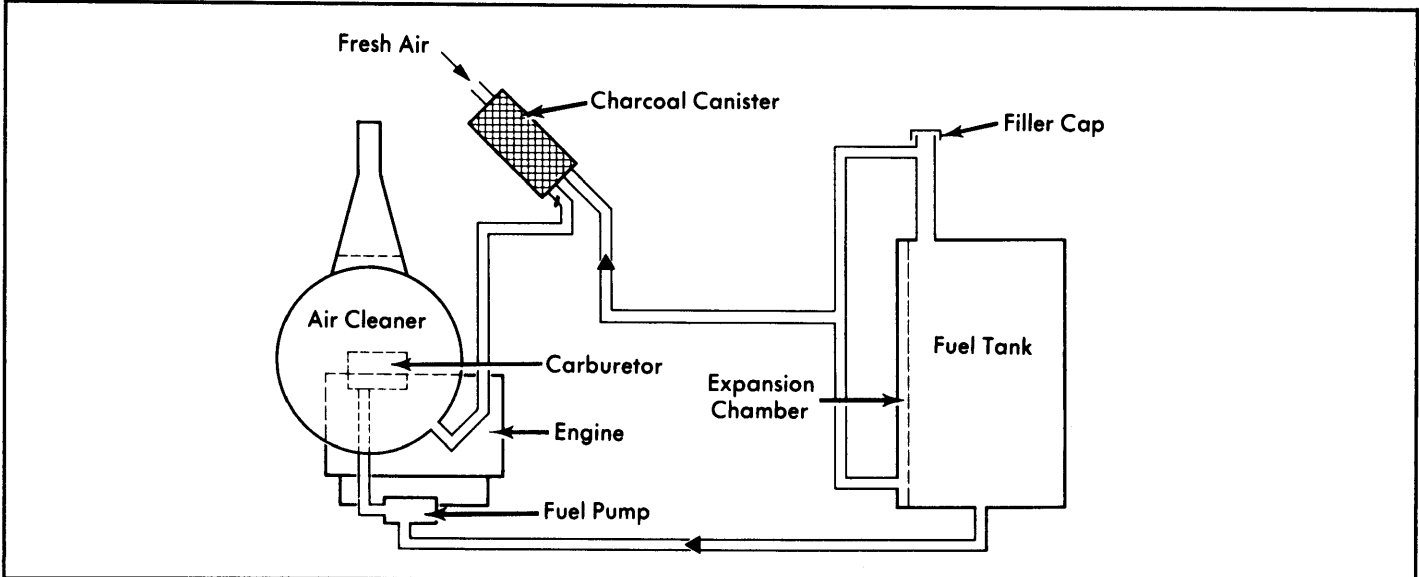

Fig. 6: 1974-75 Dasher Fuel Evaporation System

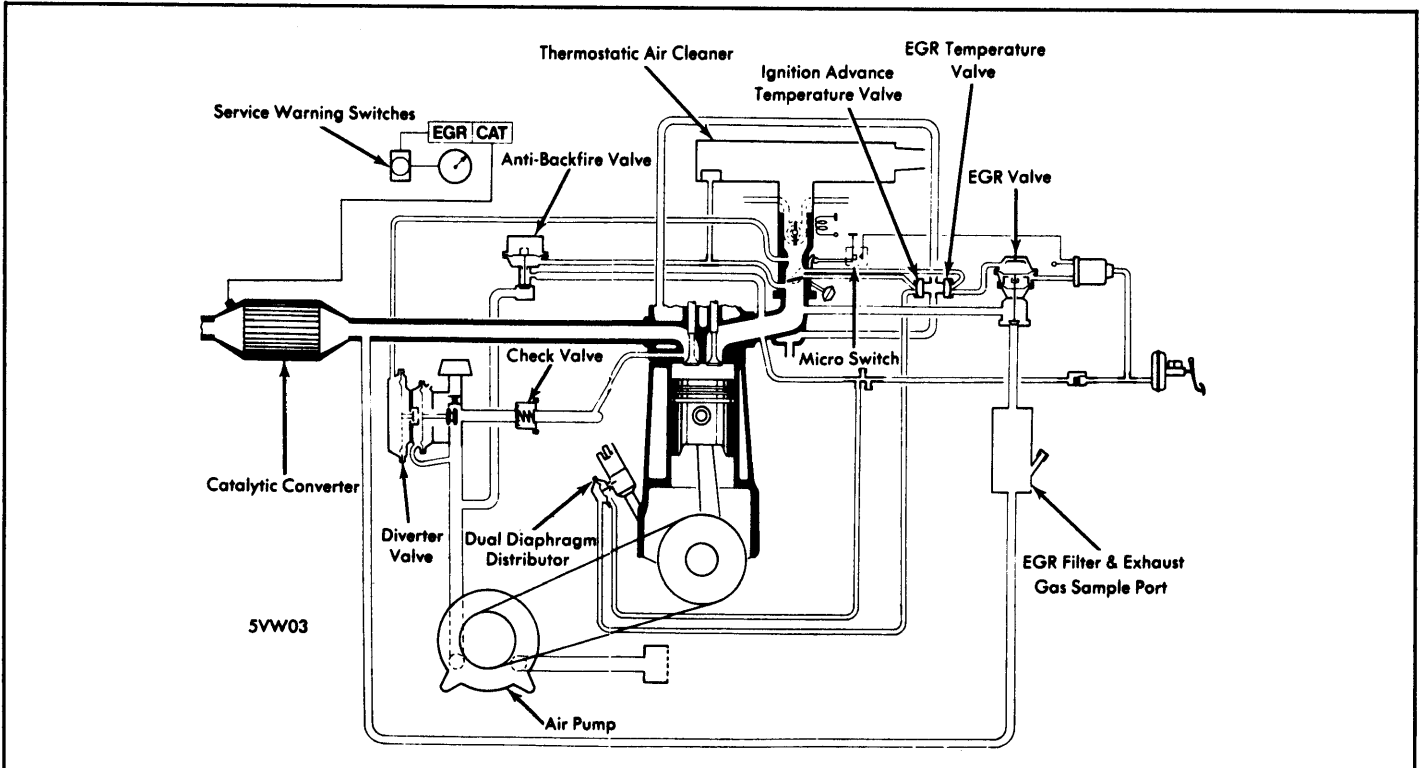

Fig. 7: 1975 Dasher, Rabbit & Scirocco Exhaust Emission System

1974-79 EXHAUST EMISSION SYSTEMS Volkswagen Vacuum Diagrams (Cont.)

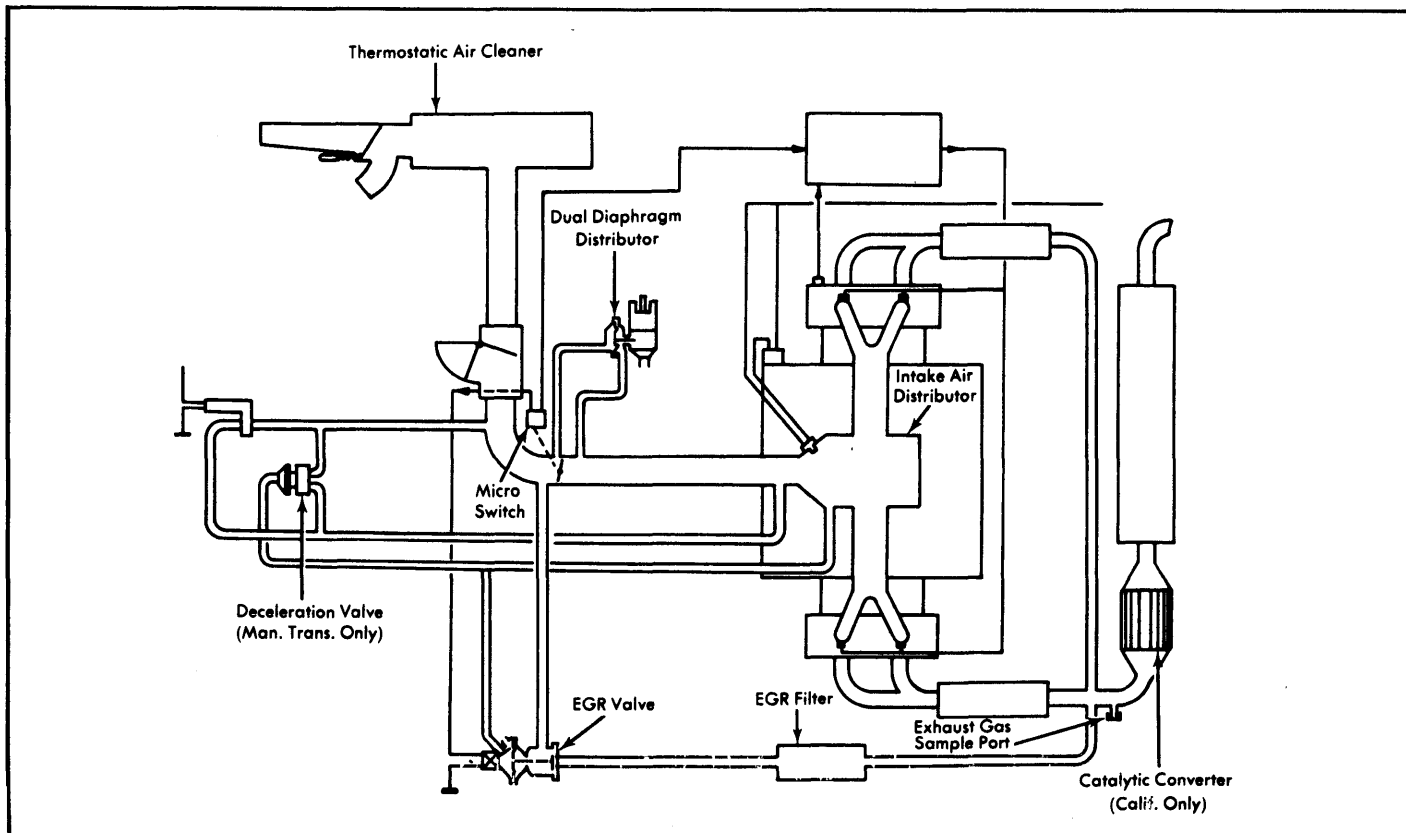

Fig. 8: 1975-76 Type 1 & Thing Exhaust Emission System

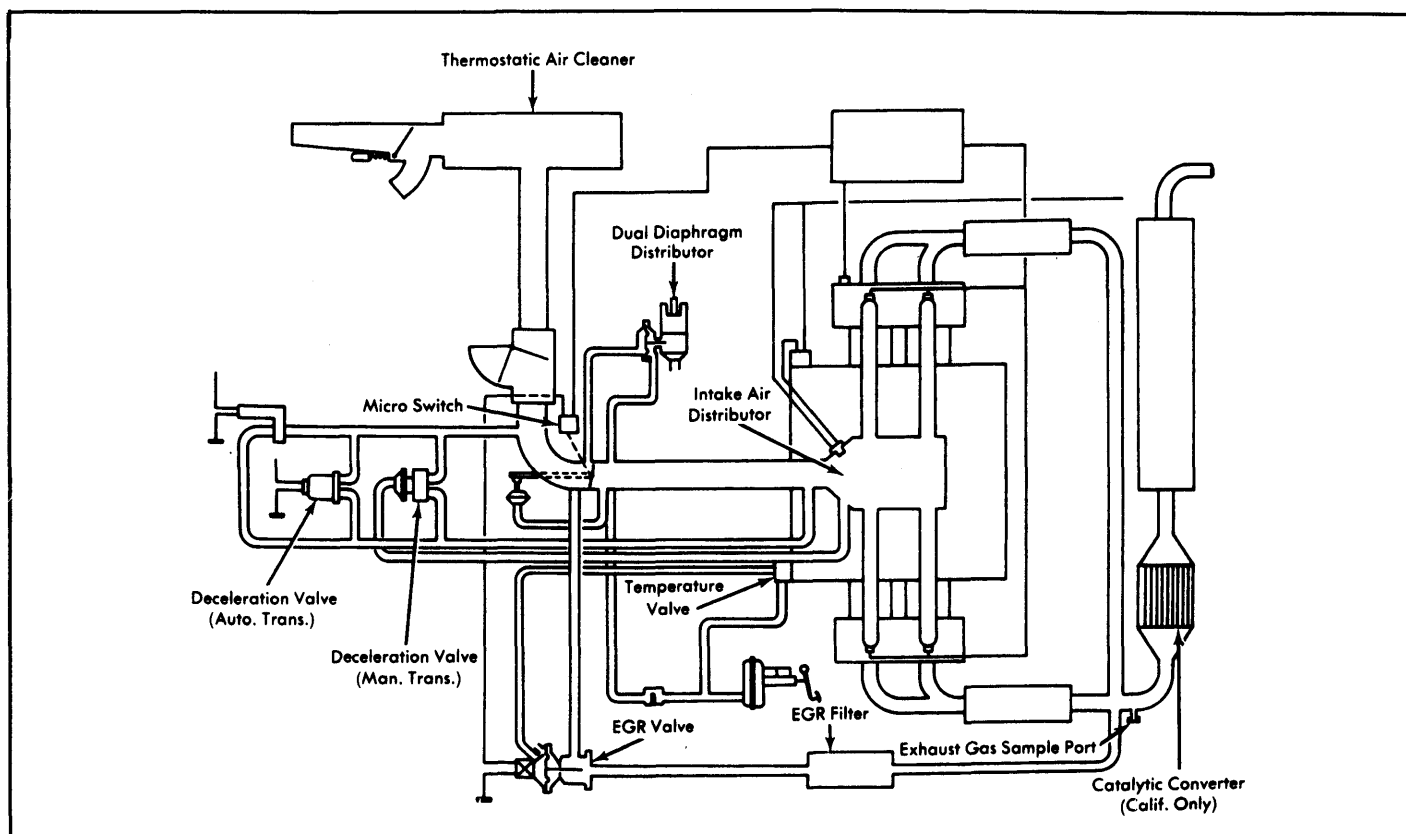

Fig. 9: 1975-76 Type 2 Exhaust Emission System

1974-79 EXHAUST EMISSION SYSTEMS Volkswagen Vacuum Diagrams (Cont.)

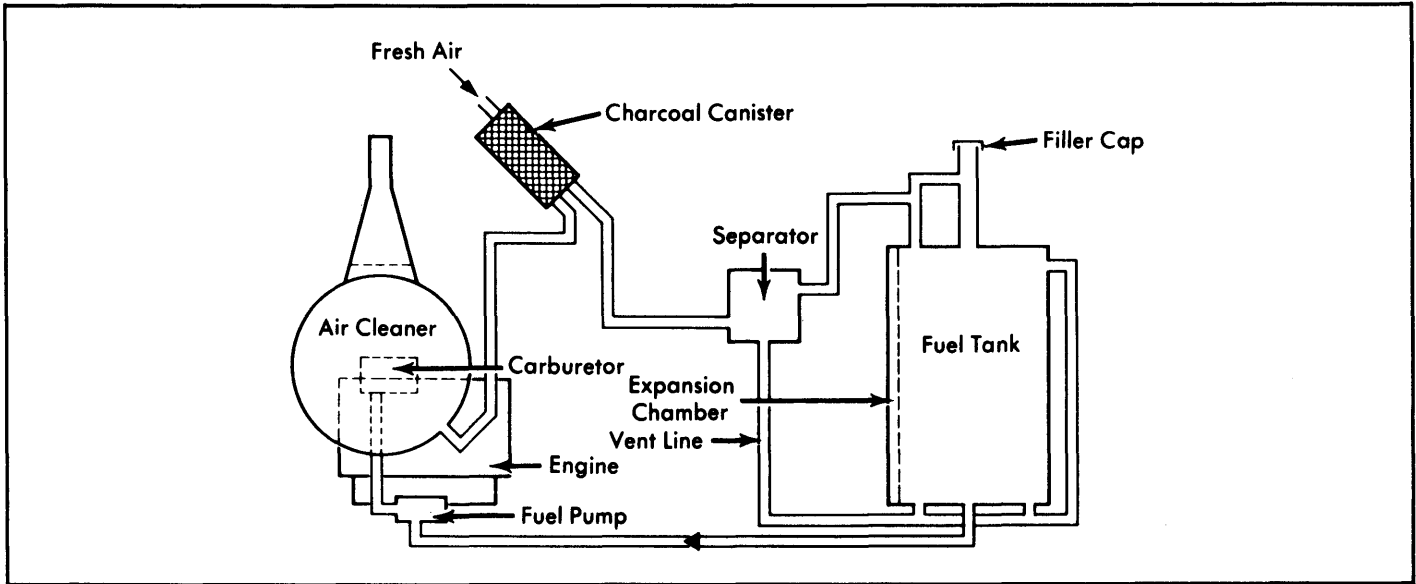

Fig. 10: 1975-76 Rabbit & Scirocco Fuel Evaporation System

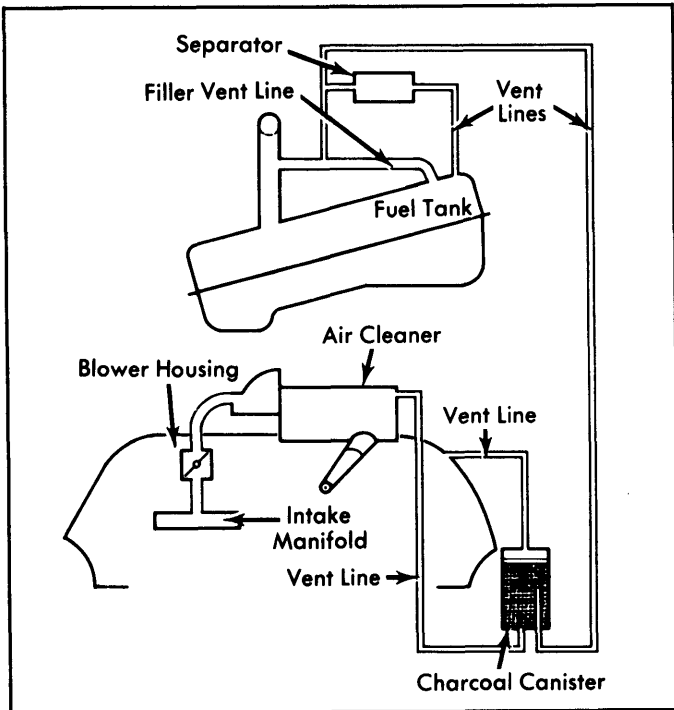

Fig. 11: 1975-76 Type 1 Fuel Evaporation System

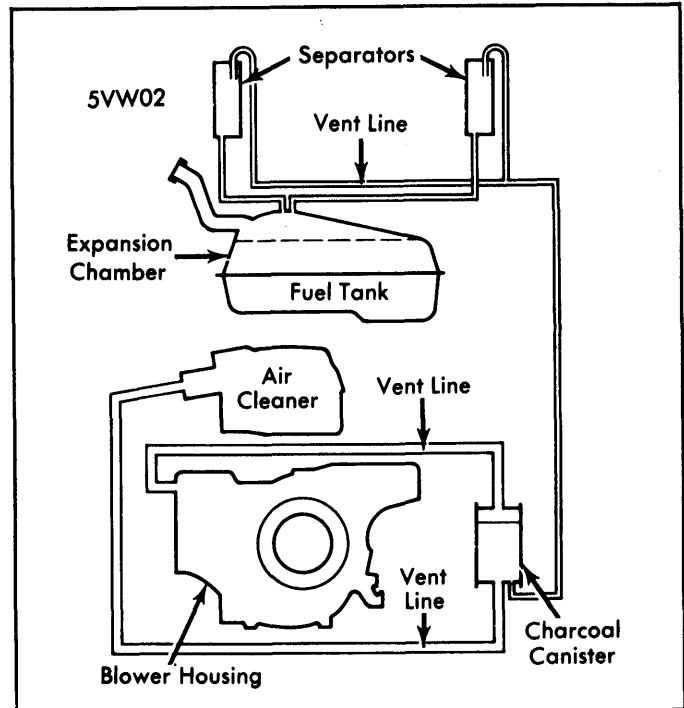

Fig. 12: 1975-76 Type 2 Fuel Evaporation System

1974-79 EXHAUST EMISSION SYSTEMS Volkswagen Vacuum Diagrams (Cont.)

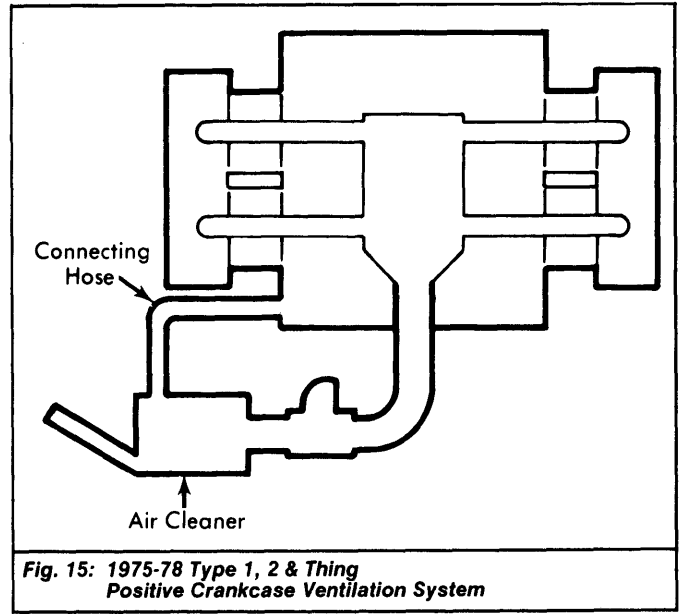
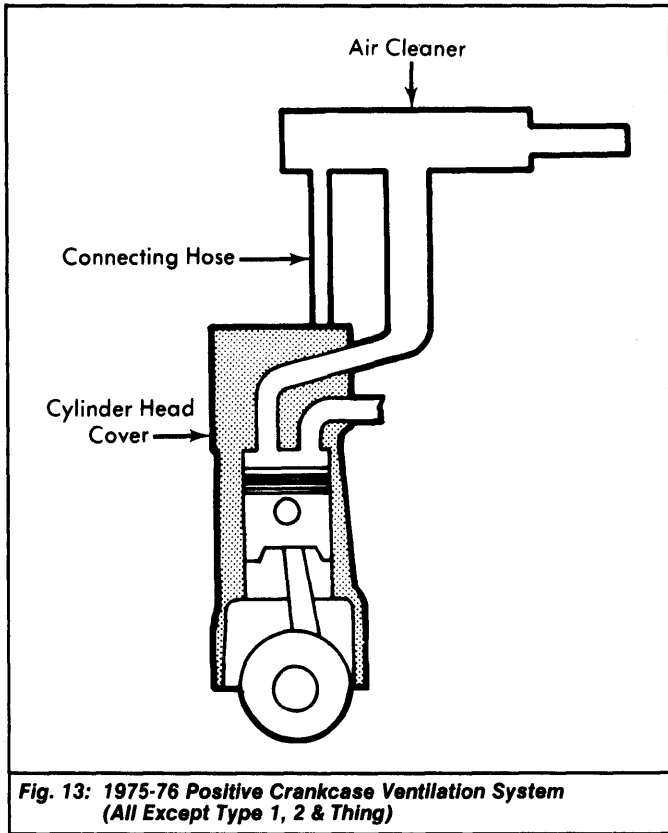

Fig. 13: 1975-76 Positive Crankcase Ventilation System (All Except Type 1, 2 & Thing)

Fig. 15: 1975-78 Type 1, 2 & Thing Positive Crankcase Ventilation System

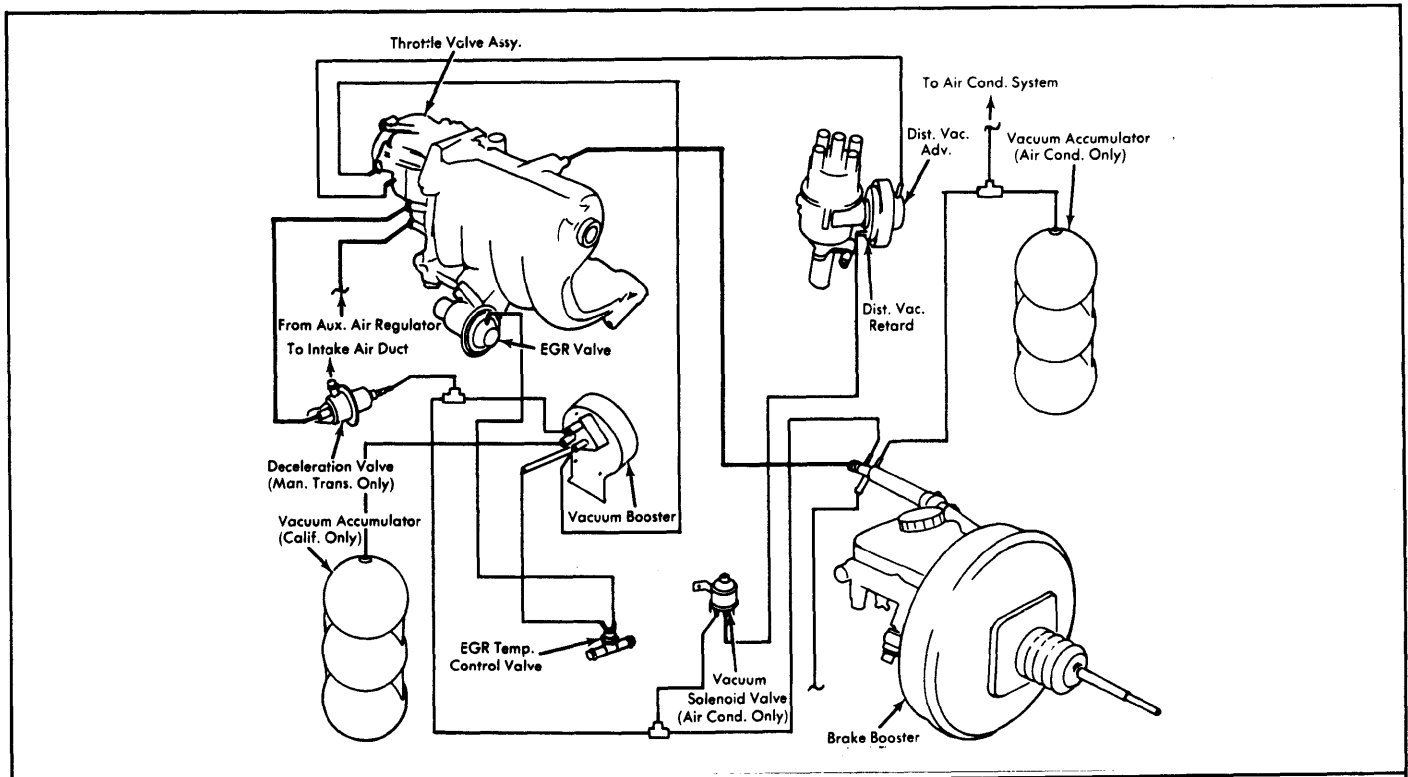

Fig. 14: 1976 Dasher Exhaust Emission System

1974-79 EXHAUST EMISSION SYSTEMS Volkswagen Vacuum Diagrams (Cont.)

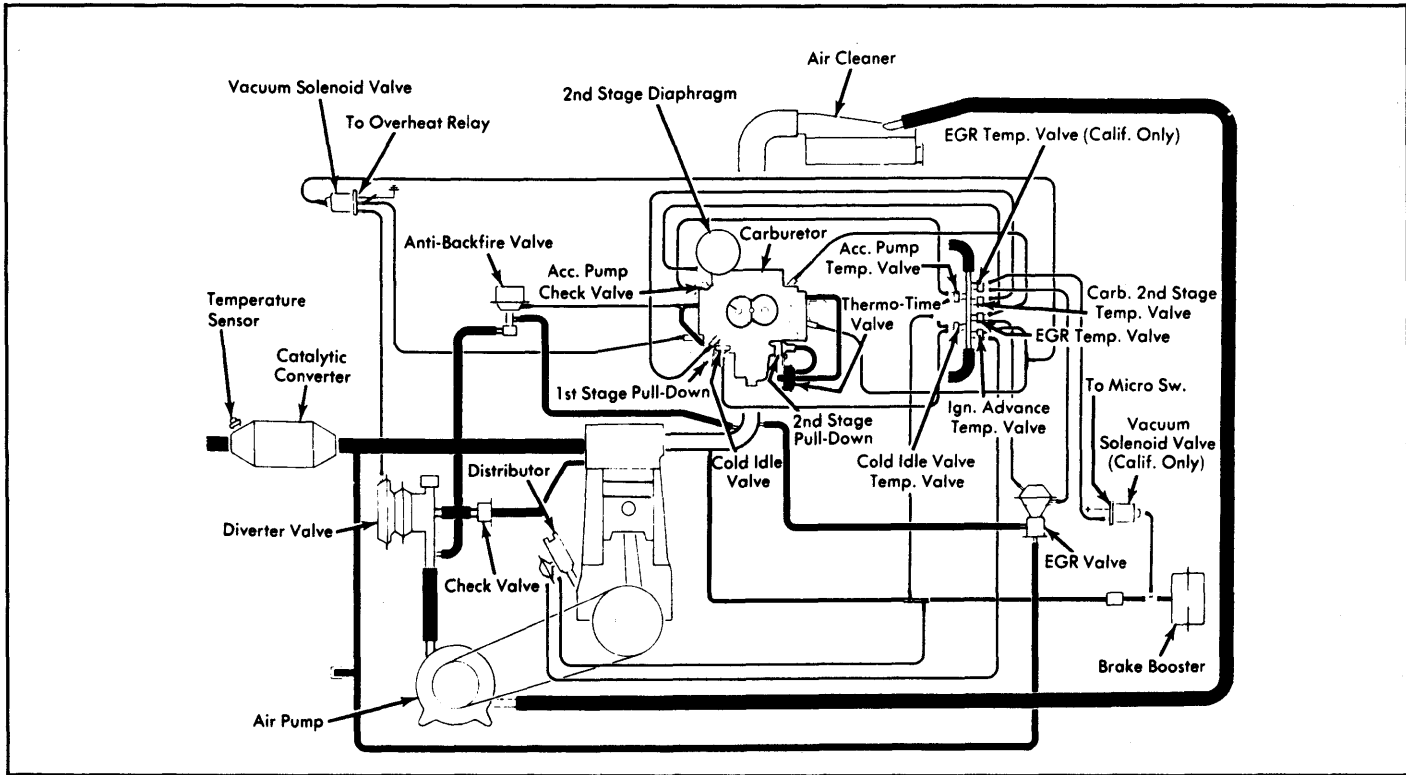

Fig. 16: 1976 Rabbit & Scirocco Exhaust Emission System

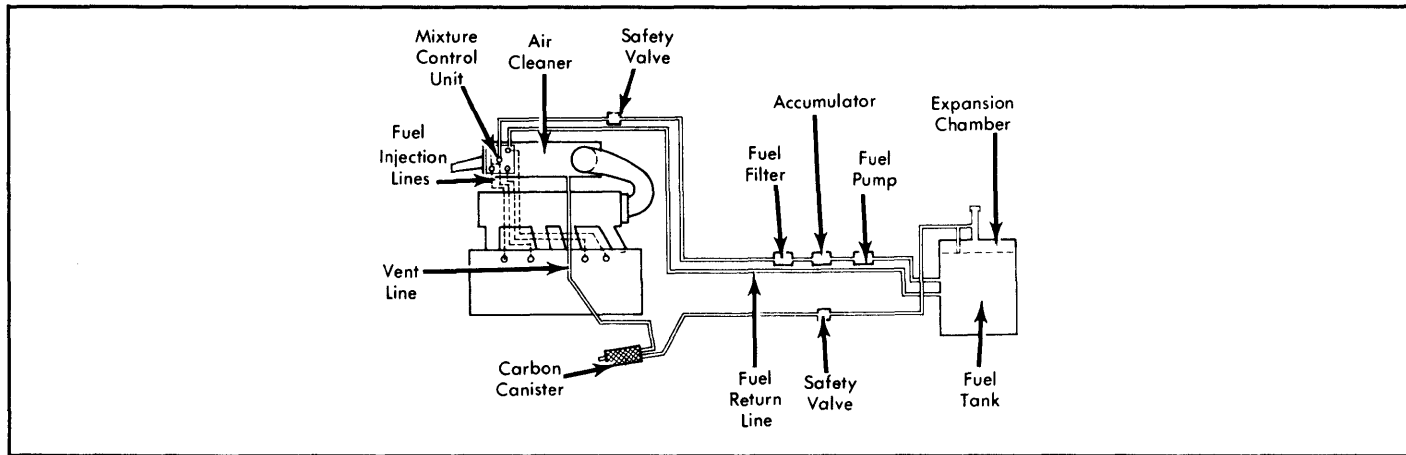

Fig. 17: 1976-78 Dasher Fuel Evaporation System

1974-79 EXHAUST EMISSION SYSTEMS Volkswagen Vacuum Diagrams (Cont.)

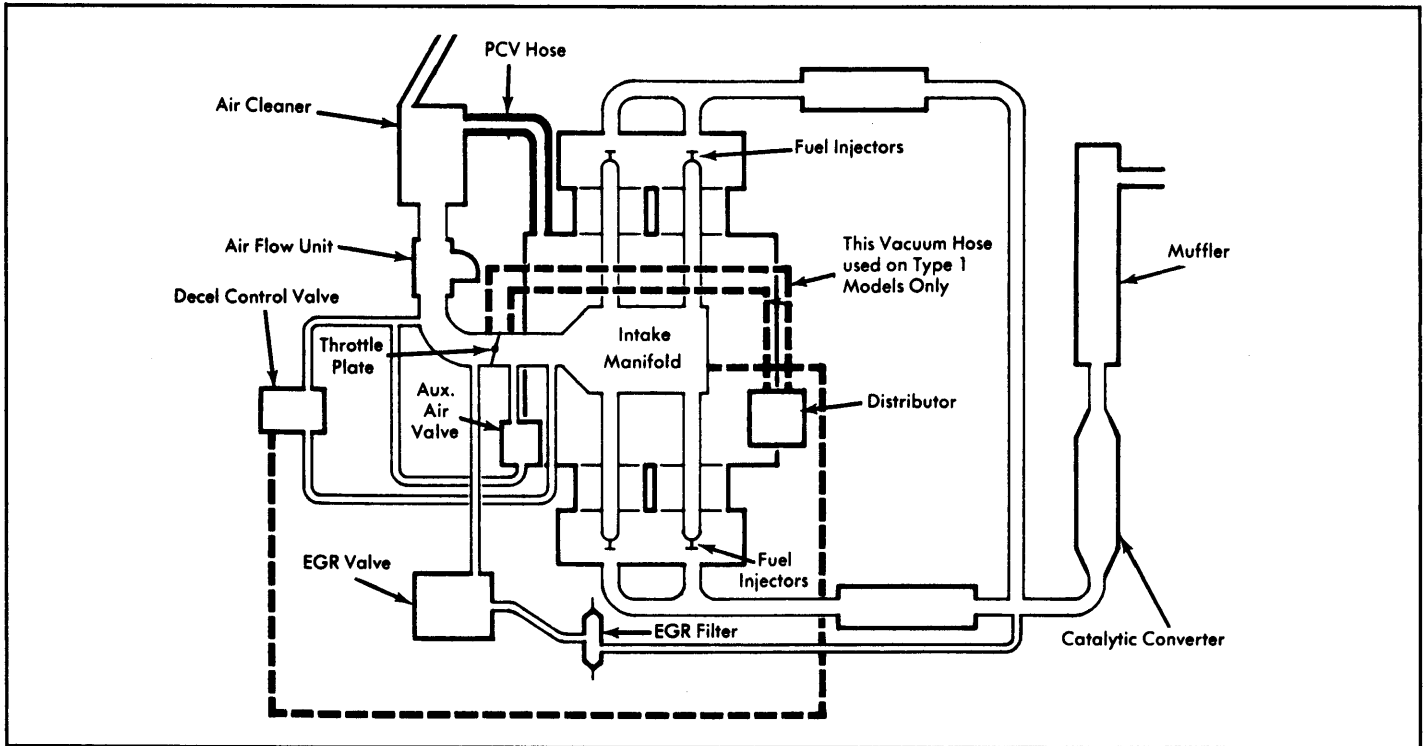

Fig. 18: 1977-78 Type 1 & 2 Exhaust Emission System

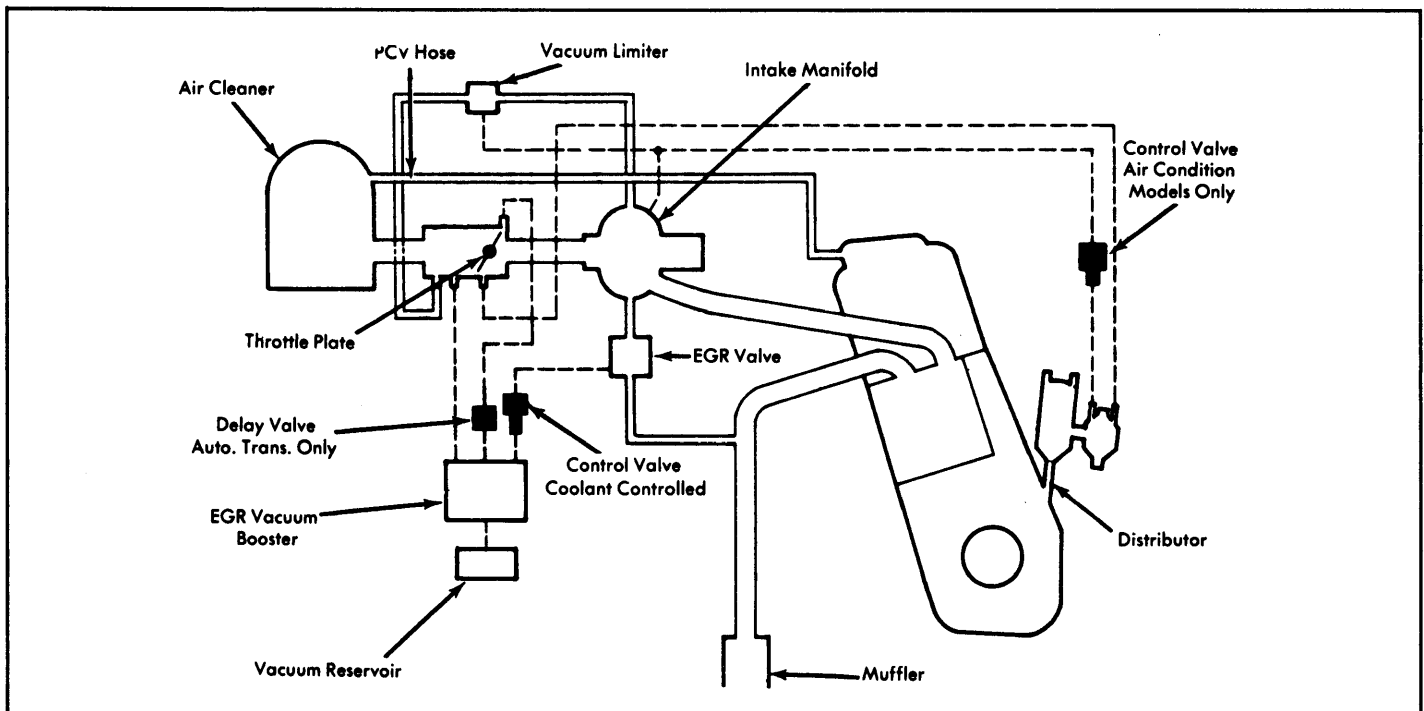

Fig. 19: 1977-78 Dasher Exhaust Emission System

1974-79 EXHAUST EMISSION SYSTEMS Volkswagen Vacuum Diagrams (Cont.)

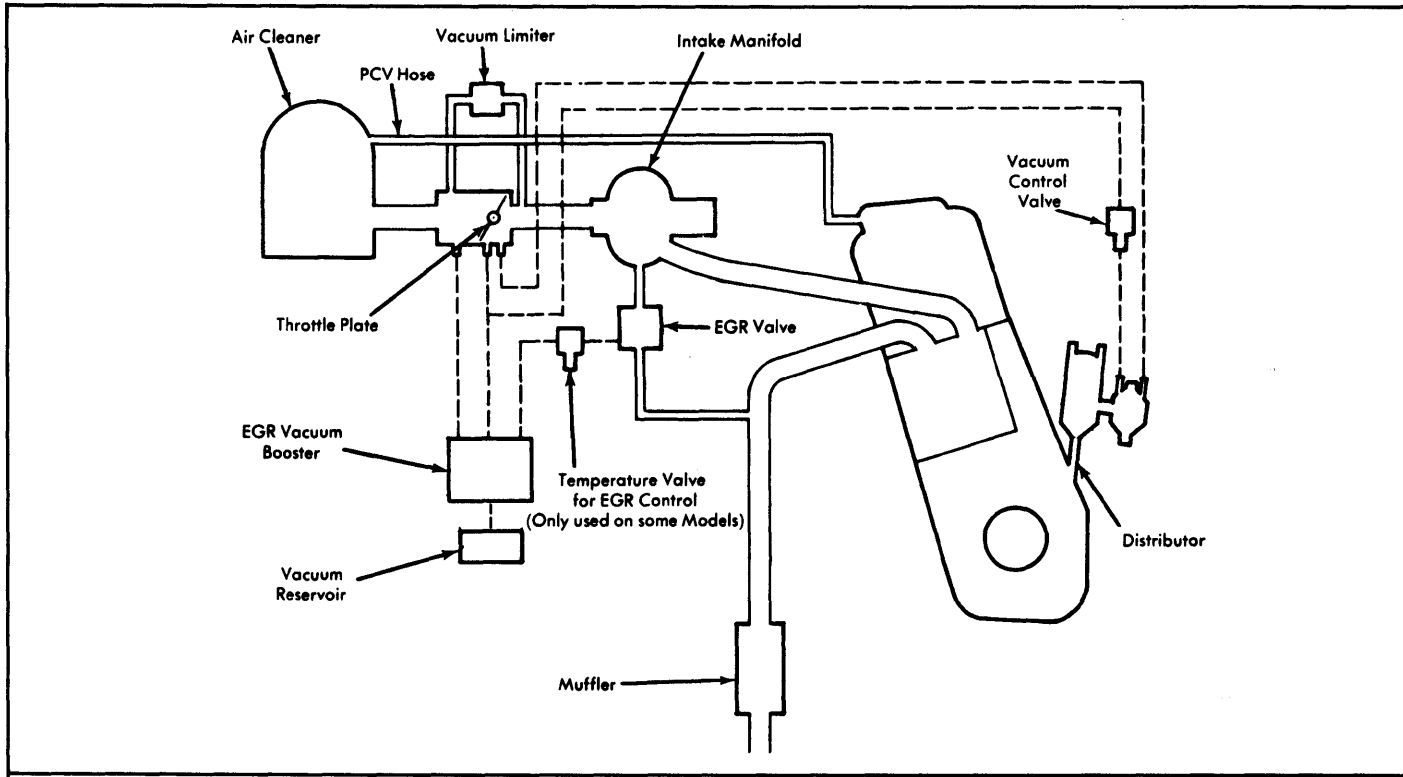

Fig. 20: 1977-78 Rabbit & Scirocco Exhaust Emission System

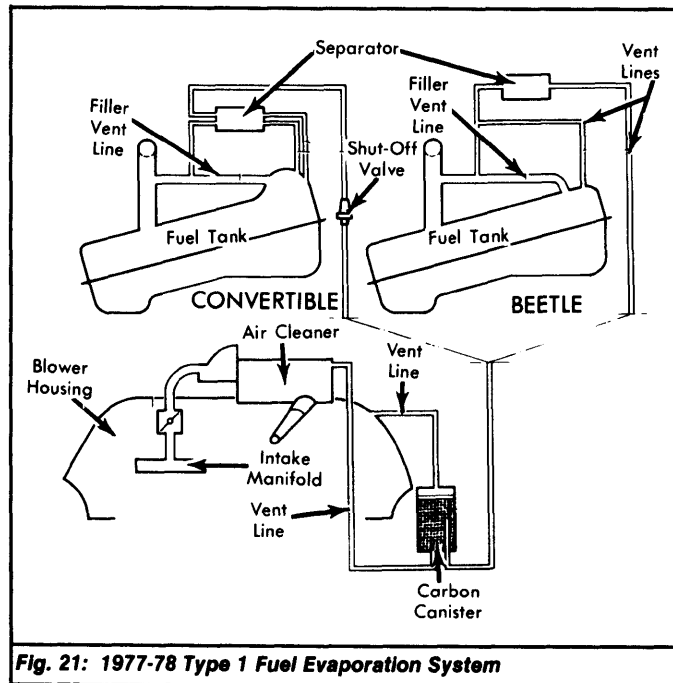

Fig. 21: 1977-78 Type 1 Fuel Evaporation System

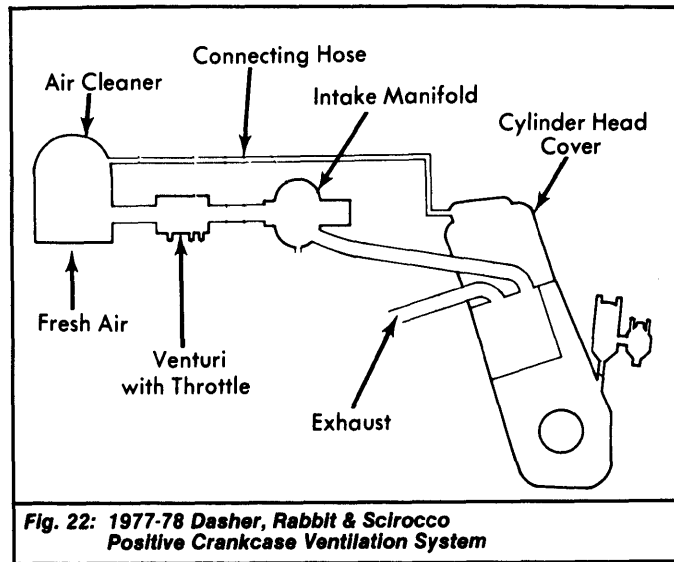

Fig. 22: 1977-78 Dasher, Rabbit & Scirocco Positive Crankcase Ventilation System

1974-79 EXHAUST EMISSION SYSTEMS Volkswagen Vacuum Diagrams (Cont.)

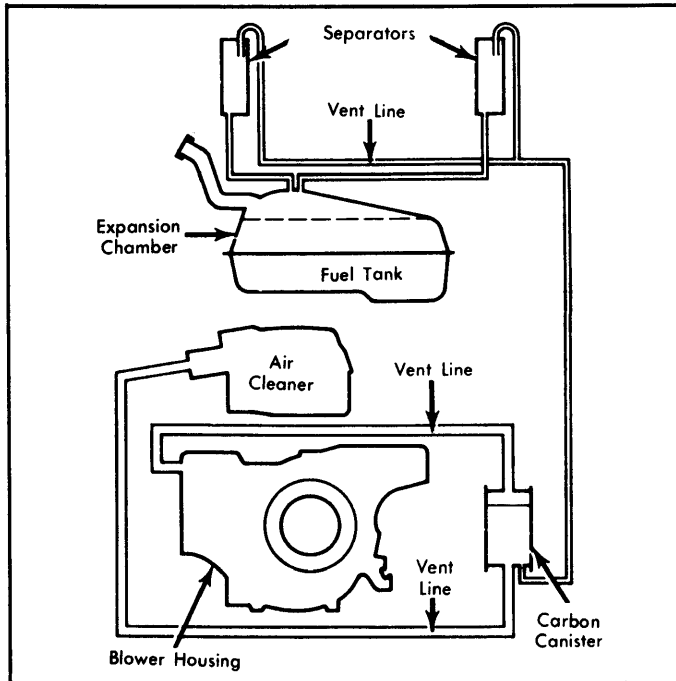

Fig. 23: 1978 Type 2 Fuel Evaporation System

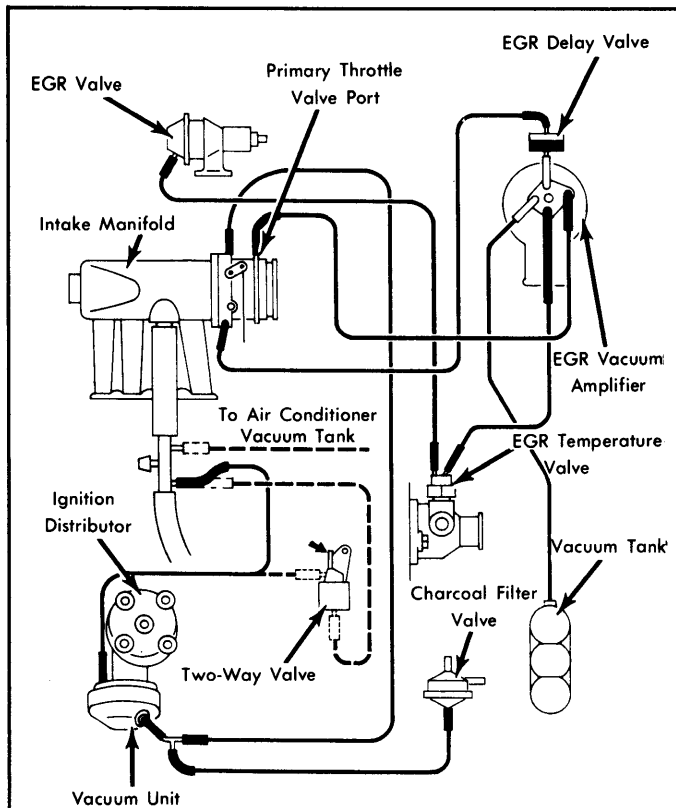

Fig. 24: 1979 Rabbit & Scirocco Exhaust Emission System (Federal & California Auto. Trans.)

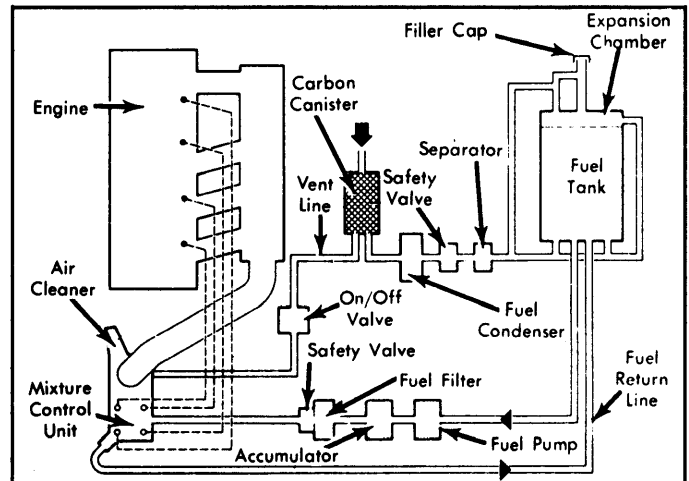

Fig. 25: 1978 Rabbit & Scirocco Fuel Evaporation System

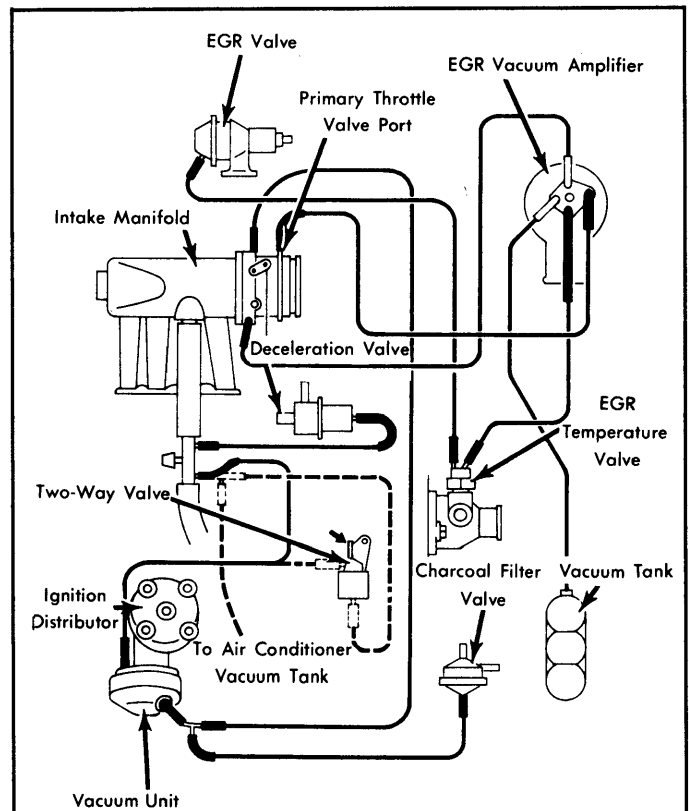

Fig. 26: 1979 Rabbit & Scirocco Exhaust Emission System (Federal Man. Trans.)

1974-79 EXHAUST EMISSION SYSTEMS Volkswagen Vacuum Diagrams (Cont.)

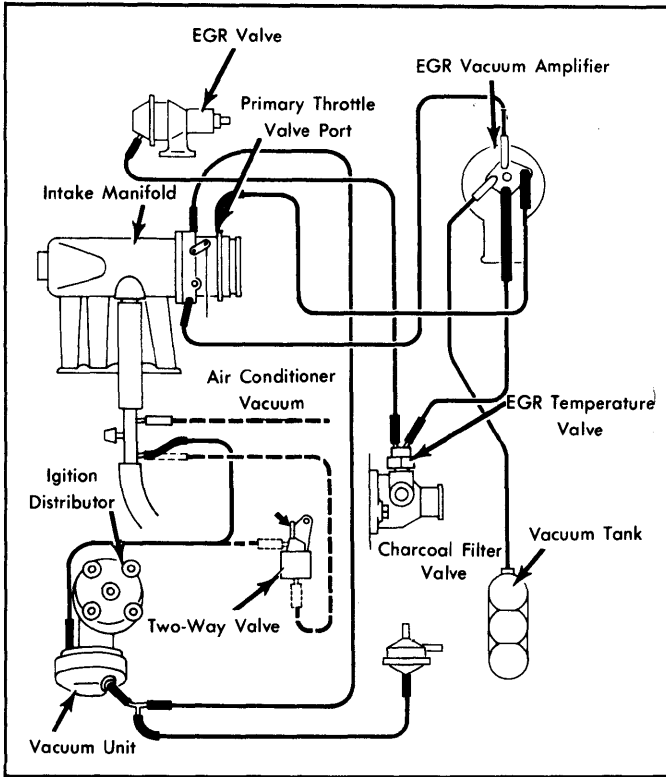

Fig. 27: 1979 Rabbit & Scirocco Exhaust Emission System (California Man. Trans.)

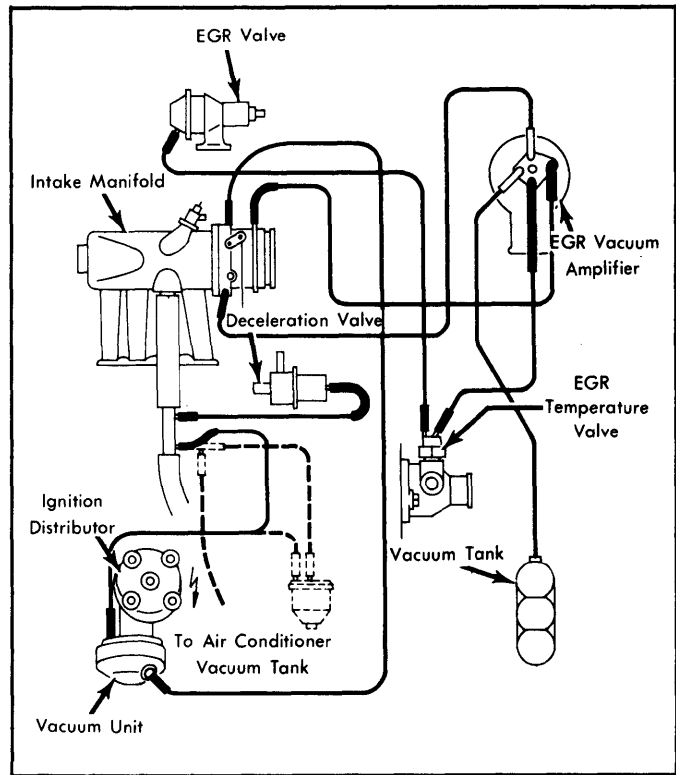

Fig. 29: 1979 Dasher Exhaust Emission System (All Except California Man. Trans.)

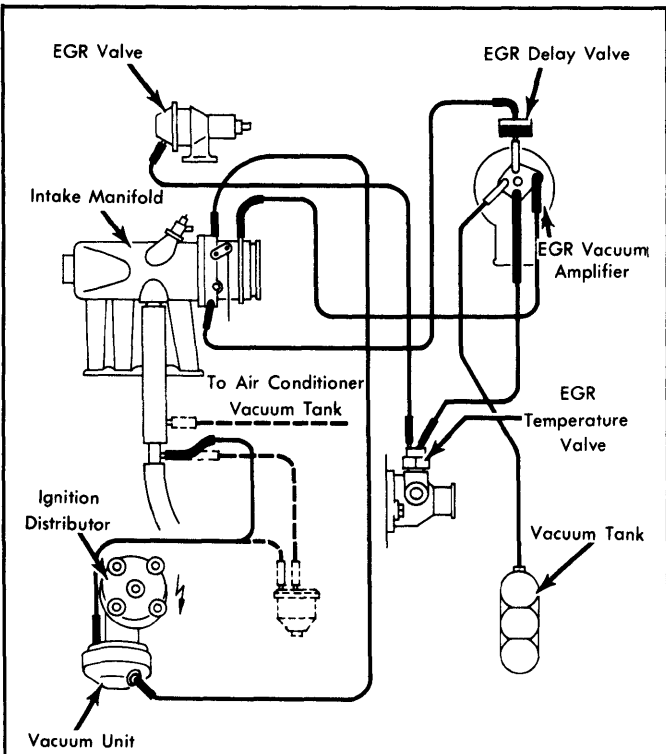

Fig. 28: 1979 Dasher Exhaust Emission System (Federal & California Auto. Trans.)

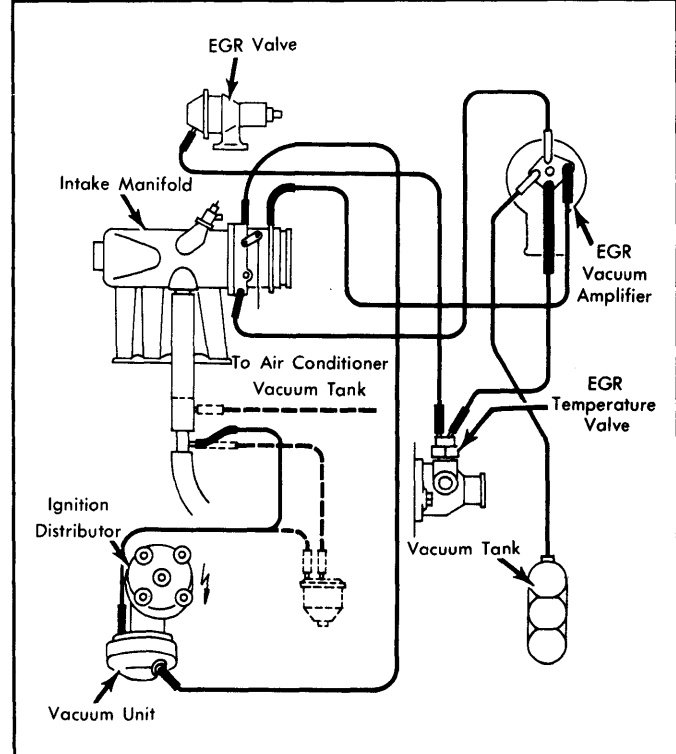

Fig. 30: 1979 Dasher Exhaust Emission System (California Man. Trans.)