

# 1982 Computerized Engine Controls 1a-57

## FORD MOTOR CO. MCU ENGINE CONTROL SYSTEM

- 2.3L (140") - Models With  
6500 Carburetor (Nationwide)
- 3.8L (232") V6 - Calif. Only
- 4.2L (255") V8 - All Calif. Models,  
Exc. Ford/Mercury
- 5.0L (302") V8 - Continental (Calif. Only) &  
Ford/Mercury (Nationwide)
- 5.8L (351") V8 - All Federal Police Models

**NOTE** - The MCU system is used in 1982 in both Ford Motor Co. passenger cars and light trucks. Information contained in this article on inline 6-cylinder engines, applies to light truck applications only.

### DESCRIPTION

The MCU control system is named for and commanded by a Microprocessor Control Unit. The micro-computer is located in the engine compartment and is capable of controlling engine air/fuel ratios, air injection, and on some models, canister purge, spark retard and idle speed. The system consists of the MCU module, air/fuel control and air injection solenoids, engine sensors, a feedback carburetor, and related circuitry.

### OPERATION

#### MICROPROCESSOR CONTROL UNIT (MCU)

The MCU is a solid-state micro-computer located on the left fender panel. It is the "brain" of the system and receives inputs and sends signals through a 24-pin connector. The MCU is capable of operating in 3 modes: Initialization, Open-Loop and Closed-Loop.

Initialization mode occurs when the engine is started. In this mode the MCU richens the fuel mixture for easy starting.

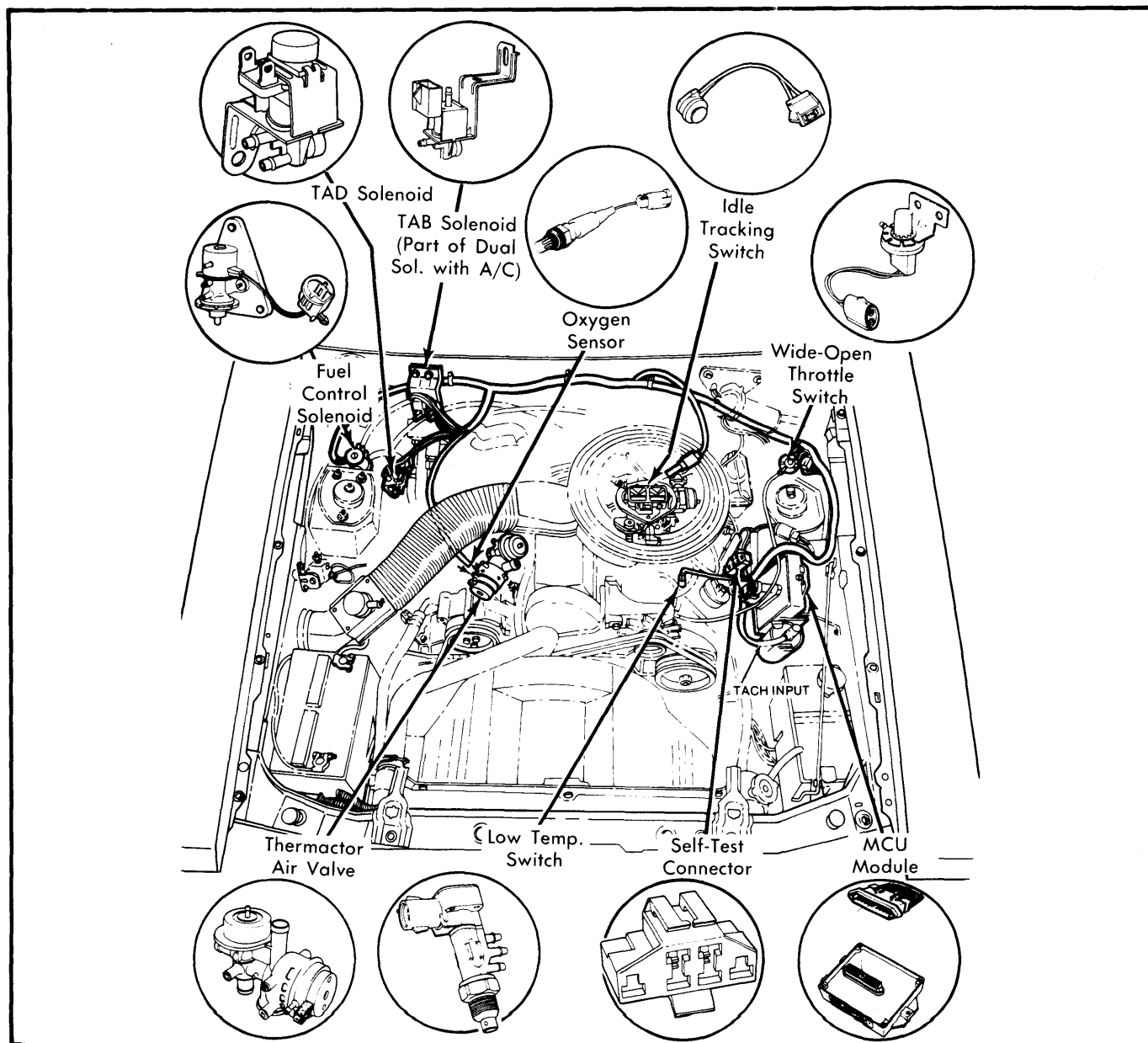

Fig. 1 4-Cylinder MCU System Layout

**FORD MOTOR CO. MCU ENGINE CONTROL SYSTEM (Cont.)**

Open-Loop operation is controlled by MCU programming. Air/fuel ratio is fixed at a pre-determined level and allows good driveability at idle, moderate-to-heavy acceleration, and deceleration. Closed-Loop operation occurs when the engine is warm and vehicle is operated at light load conditions. In closed loop, the MCU controls the air/fuel mixture in response to signals from an oxygen sensor in the exhaust manifold.

**ENGINE SENSORS**

**Coolant Temperature** – Various switches are used to signal temperature changes to the MCU. Vehicles with 4 cylinder engines use an electric coolant switch mounted on a Ported Vacuum Switch (PVS). On 6 cylinder engines, a PVS sends vacuum to an electrical switch (mounted with 3 others) which is open when vacuum is applied. On V8 engines, 2 switches are

mounted with sensors in a coolant passage. One switch is open when the engine is warm; the other is open both when the engine is cold and when it has overheated.

**Engine Load Sensor** – Engine load is determined by vacuum level, and throttle position. On 4 cylinder engines, an idle tracking switch signals the MCU when the throttle is closed. A vacuum switch signals wide open conditions. On 6 and V8 models, 3 vacuum switches are used to signal cruise, deceleration, and wide-open-throttle conditions. No throttle switch is used on these models.

**Oxygen Sensor** – All models use an oxygen sensor mounted in the exhaust manifold. This sensor sends a low voltage signal to the MCU to indicate rich or lean mixture. When mixture is lean, the signal is less than 0.2 volts. When rich, the sensor voltage is slightly above 0.6 volts.

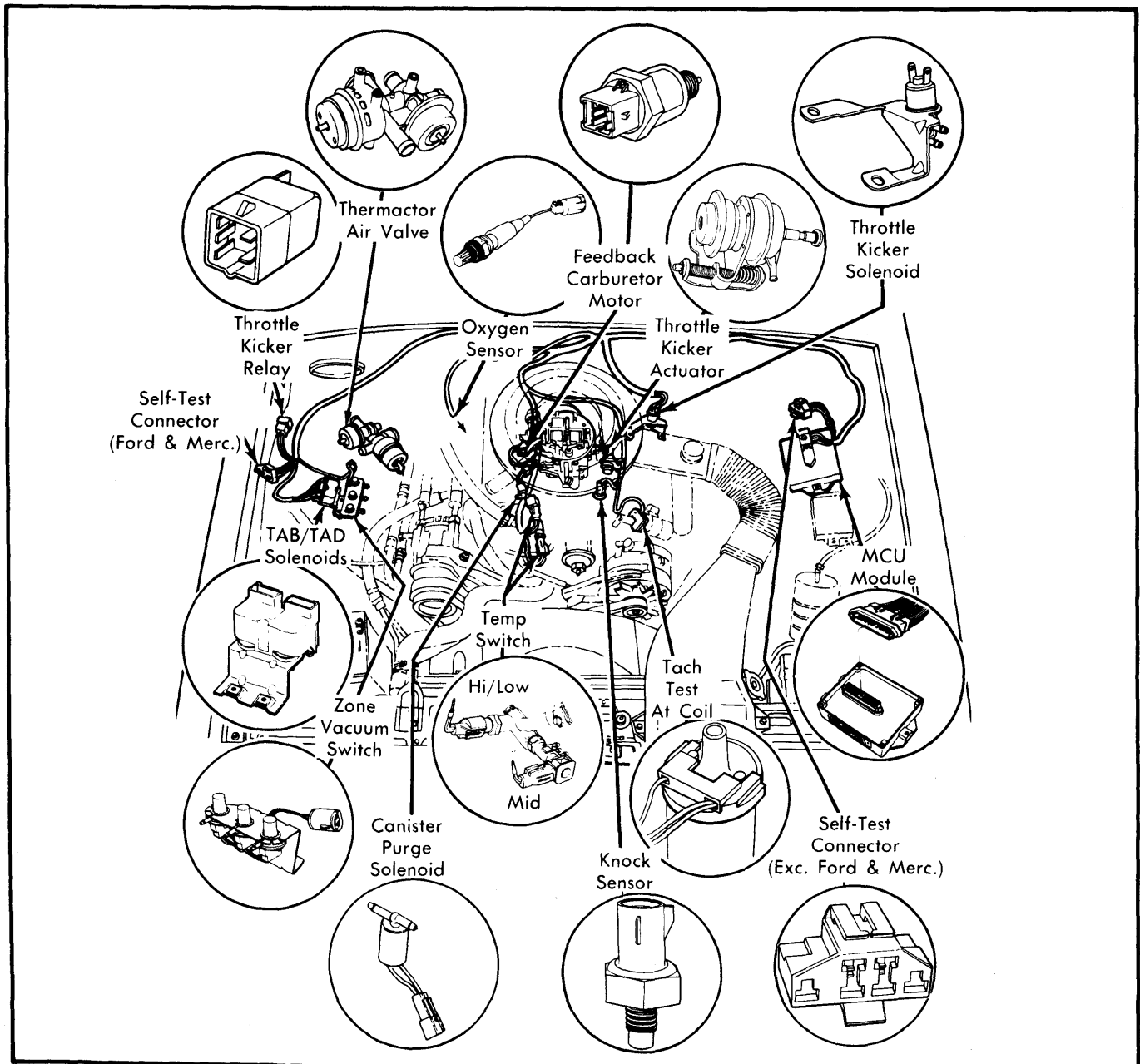

**Fig. 2 V8 MCU System Layout**

## FORD MOTOR CO. MCU ENGINE CONTROL SYSTEM (Cont.)

**Engine Speed** — The MCU receives a direct signal from the "Tach Test" terminal on the coil. It uses this signal to calculate engine speed and alters its air/fuel correction based on this speed.

**Knock Sensor** — The knock sensor is used on some 6 & V8 engines to help reduce detonation. It allows a voltage signal to pass through when it senses detonation. The MCU uses this signal to either bleed off distributor vacuum (6 Cyl.) or signal ignition module (V8). The MCU otherwise does not control ignition timing.

**Self-Test Connector** — The MCU can self-diagnose most common operating problems. In order to initiate and read the diagnostic program, connections are made to the Self-Test connector. It provides voltage pulses which can be read by a specialized tester (Rotunda 07-0004) or a dial-type voltmeter.

### ENGINE CONTROLS

Engine controls are the devices the MCU operates to accomplish its task of improving driveability and reducing emissions. These devices vary with engine type, but are all controlled electrically.

**Thermactor Controls** — These controls direct the flow of air from an air pump to either the exhaust manifold, the catalytic converter, or the atmosphere. On all models, a pair of solenoid valves control vacuum flow which operates a Thermactor Air Valve assembly. These valves are called the Thermactor Air Bypass (TAB) and Thermactor Air Diverter (TAD) valves.

In normal operation, the air is injected in the catalytic converter to improve reduction of emissions. When the engine is idling or decelerating for long periods of time, air is diverted to atmosphere. When the engine is first warming, air is injected into the exhaust manifold to help heat exhaust gases before they reach the converter.

**Air/Fuel Controls** — In 4 and 6 cylinder applications, the MCU provides a pulsed voltage signal which operates a fuel control solenoid/vacuum regulator (4 Cyl.) or a fuel control solenoid (6 Cyl.). On 4 cylinder engines, the vacuum is applied to a mixture control diaphragm in the carburetor, while 6 cylinder engines are directly operated by the solenoid which is a part of the carburetor.

On V8 engines, the MCU provides current to a feedback motor in the carburetor, also known as a Feedback Carburetor Actuator (FBCA). This motor extends and retracts a shaft which alters a bleed-air orifice in the carburetor.

**Canister Purge Solenoid** — On 6 and V8 applications, a canister purge solenoid is controlled by the MCU. When engine conditions are optimum, the solenoid is opened and the fuel vapor canister is purged.

**Throttle Kicker** — On some V8 engines, a throttle kicker is used to improve idle. The MCU applies voltage to a solenoid, providing vacuum to operate the kicker.

**Ignition Control** — Some 6 and V8 applications have a knock sensor to reduce detonation. The MCU retards timing when the sensor signals detonation. On 6 cylinder engines, the MCU opens a spark retard solenoid, which bleeds off distributor advance vacuum. On V8 engines, the MCU sends a signal to a 3-connector ignition module, which then retards timing.

### DIAGNOSIS & TESTING

The MCU system is capable of diagnosing some problems which may occur. To determine which components should be checked, perform the "Functional Test" which follows. If problems do exist, a service code will be displayed (as pulses on a voltmeter). Locate the appropriate test chart and follow the repair procedure as instructed. Do not use the test charts unless referred to them by the "Functional Test", or you may replace some components unnecessarily.

### EQUIPMENT REQUIRED

All Systems  
Dial Voltmeter (0-20v scale)  
Digital Voltmeter (DVOM — Min. impedance 10 megohms)  
Vacuum Gauge (0-30 in. Hg)  
Vacuum Pump  
Tachometer  
Jumper Wire  
Additional Equipment for V8  
Timing Light  
Test Lamp (12v)  
Torque Wrench with deep 1 1/8" socket  
Steel Rod (socket extension) & Tap Hammer  
Watch with second hand

### PREPARATION FOR TESTING

- 1) Check vacuum hoses for leaks, cracks, or improper routing. Repair or replace as necessary.
- 2) Check electrical connections. Repair any frayed or broken wires. Ensure that all connections are clean and tight.
- 3) Turn all accessories off. Place transmission in neutral and set parking brake. Warm engine to normal operating temperature. If air cleaner must be moved, leave all vacuum hoses attached.

**NOTE** — If vehicle will not start, see No Start Test (No. 1 for 4 and 6 Cylinder, No. 18 for V8).

- 4) Turn ignition off. Locate Self-Test connector and insert a jumper wire between ground and Trigger sockets. Connect the positive lead of a needle-type voltmeter to vehicle battery positive terminal, and the negative lead to Self-Test output socket. Set voltmeter on 15-20 volt scale. Battery voltage may be shown.

- 5) On 4 cylinder engines, disable canister purge system by disconnecting and plugging hose from engine side of canister purge valve. On V8 engines, remove PCV valve from valve cover.

### FUNCTIONAL TEST

**NOTE** — Service codes are shown by voltage pulses. The first digit is indicated by a series of pulses, then the needle drops to zero for 2 seconds, then the second digit of the code is displayed. After all service codes are displayed, a 4 second pause will occur and then the codes will be repeated.

# 1a-60 1982 Computerized Engine Controls

## FORD MOTOR CO. MCU ENGINE CONTROL SYSTEM (Cont.)

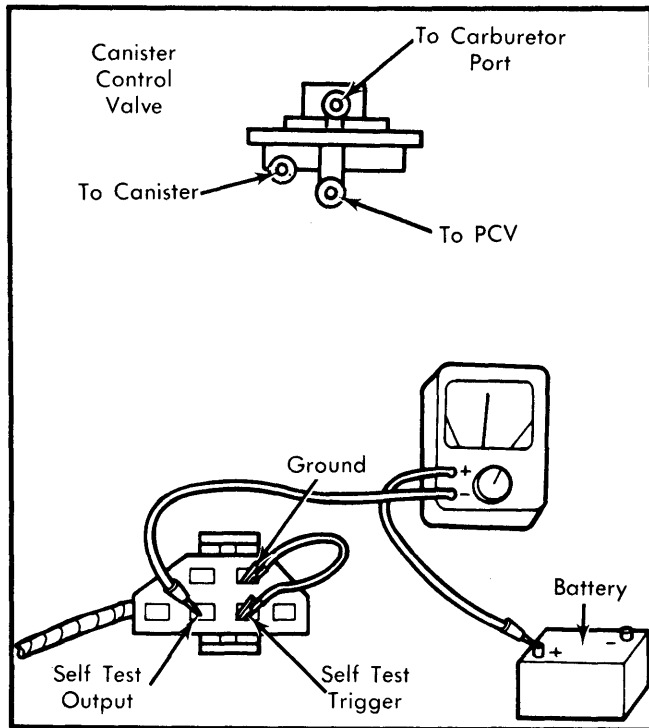

Fig. 3 Connections for Functional Test

**Key On, Engine Off Test** – Turn key on, but do not start engine. Watch voltmeter for code pulses which should appear in approximately 5 seconds. Ignore any initial surge of voltage when key is turned on. Record code(s).

**NOTE** – If voltmeter does not pulse, but shows steady high or low readings, see test 14 (4 and 6 cylinder) or 29 (V8).

**Engine Running Test (4 and 6 Cylinder)** – 1) Start engine and raise speed to 2500-3000 RPM within 20 seconds after start. Hold RPM until initial pulses appear (2 for 4 Cyl., 3 for 6 Cyl.). Continue holding speed until code pulses begin (10-40 seconds).

**NOTE** – If more than 2 or 3 initial pulses occur, go to test 15 to check for an open circuit in the tachometer signal.

2) Return engine to idle when codes begin. Codes will be repeated once. Record codes, then stop engine and reconnect canister purge hose. Refer to code chart to locate appropriate test.

**Engine Running Test (V8)** – 1) Check to see if engine has knock sensor. If so, have steel bar (socket extension) and tap hammer handy. Start engine and run at 2000 RPM for 2 minutes. Turn engine off, then immediately restart.

2) Observe voltmeter for 4 initial pulses. As soon as pulses appear, hold steel bar against manifold near knock sensor and tap bar lightly with hammer for 15 seconds.

**NOTE** – If more than 4 pulses appear, check for open circuit between coil and pin 8 of MCU module connector.

3) Observe and record service codes. After 4 second pause, code(s) will be repeated. Stop engine and reconnect PCV valve. Refer to code chart to locate appropriate test.

### NON-CODE TESTS

Perform the following tests after vehicle has passed all other diagnosed tests.

**Canister Purge Check (6 Cyl.)** – Tee in vacuum gauge between canister and canister purge solenoid. Stop engine, then restart and raise RPM to initiate Self-Test. Observe vacuum gauge during initial pulses. If vacuum pulses 3 times between 0-1 in. Hg, go to Spark Retard Solenoid Check. If vacuum is always high or low, go to test 16, Canister Purge Solenoid test.

**Spark Retard Solenoid Check (6 Cyl.)** – Remove vacuum gauge from canister purge hose and reconnect hose. Remove filter from spark retard solenoid and connect vacuum gauge to port. Turn engine off, then restart it and increase RPM to initiate Self-Test. If gauge pulses 3 times, system and MCU are okay. If vacuum remains high or low go to test 17, Spark Retard Solenoid test.

**Cold Drive Complaint (4 and 6 Cyl.)** – If complaint occurred when engine was cold, recheck coolant temperature switch for proper operation. Go to Low Temperature Switch test, step 5) for 4 Cyl., or Low Temperature Vacuum Switch test, step 4) for 6 Cyl.

**Closed or Light Throttle Drive Complaint (All)** – Check resistance between Self-Test output socket and ground. If continuity is found, repair short to ground.

**Spark Knock Test (V8)** – 1) If vehicle is not equipped with knock sensor or 3-connector ignition module, check ignition timing and reset as necessary. Testing is now complete. MCU system is functional and problem must be in some other area.

2) If vehicle is equipped with knock sensor or 3-connector module, disconnect knock sensor and set timing. Disconnect 2-wire connector (Yellow and Black/White wires) and jumper wires together at module.

3) Check ignition timing. If timing retards 16-20°, reconnect module and go to next step. If timing does not retard, replace module and repeat Spark Knock Test.

4) With vehicle at normal operating temperature, set fast idle screw on cam step that will maintain engine speed above 1200 RPM. Read and record ignition timing.

5) Locate zone vacuum switch, then remove and plug hose from it. Recheck timing. If timing retards more than 5 degrees and system has a knock sensor, go to step 7). If no knock sensor, testing is complete, MCU system okay. If timing does not retard 5 degrees, go to next step.

6) While engine is still at 1200 RPM, disconnect 2-wire connector at ignition module. If timing retards, check Yellow wire for short to ground. If okay, replace MCU module and retest. If timing does not retard, check Yellow wire for open circuit. If okay, replace MCU module and retest.

7) Reconnect knock sensor. Repeat MCU Running Test, but do not simulate knock by tapping rod on intake manifold. If service code 25 is obtained, MCU system is okay. If any other code is observed, replace knock sensor and retest.

# 1982 Computerized Engine Controls 1a-61

## FORD MOTOR CO. MCU ENGINE CONTROL SYSTEM (Cont.)

FORD MCU SYSTEM SERVICE CODES & SUB-ROUTINE TESTS			
Code	4-Cylinder Test	6-Cylinder Test	V8 Test
None	<b>14</b> Functional Test Not Operating	<b>14</b> Functional Test Not Operating	<b>29</b> No Self-Test Output
No Start	<b>1</b> No Start Test	<b>1</b> No Start Test	<b>18</b> No Start Test
<b>11</b>	System OK	System OK	System OK
<b>12</b>	.....	.....	<b>24</b> Idle Speed Incorrect
<b>25</b>	.....	.....	<b>28</b> Knock Detection System
<b>33</b>	<b>13</b> Running Test Not Initiated	<b>13</b> Running Test Not Initiated	.....
<b>41</b>	<b>6</b> Fuel Always Lean	<b>8</b> Fuel Always Lean	<b>22</b> Fuel Always Lean
<b>42</b>	<b>7</b> Fuel Always Rich	<b>9</b> Fuel Always Rich	<b>23</b> Fuel Always Rich
<b>44</b>	<b>10</b> Thermactor System	<b>10</b> Thermactor System	<b>25</b> Thermactor System
<b>45</b>	<b>11</b> Thermactor Air Diverter	<b>11</b> Thermactor Air Diverter	<b>26</b> Thermactor Air Diverter
<b>46</b>	<b>12</b> Thermactor Air By-Pass	<b>12</b> Thermactor Air By-Pass	<b>27</b> Thermactor Air By-Pass
<b>51</b>	<b>2</b> Low Temperature Switch	<b>5</b> Low Temperature Vacuum Switch	<b>20</b> Vacuum Switch Open
<b>52</b>	<b>3</b> Idle Tracking Switch	<b>4</b> Vacuum Switch	.....
<b>53</b>	<b>4</b> Vacuum Switch	<b>4</b> Vacuum Switch	<b>19</b> Electrical Temp. Switch Open
<b>54</b>	.....	.....	<b>19</b> Electrical Temp. Switch Open
<b>55</b>	.....	.....	<b>20</b> Vacuum Switch Open
<b>56</b>	.....	<b>4</b> Vacuum Switch	.....
<b>61</b>	.....	.....	<b>21</b> Vacuum Switch Closed
<b>62</b>	<b>3</b> Idle Tracking Switch	<b>4</b> Vacuum Switch	Baro
<b>63</b>	<b>4</b> Vacuum Switch	<b>4</b> Vacuum Switch	.....
<b>65</b>	.....	.....	<b>21</b> Vacuum Switch Closed
<b>66</b>	.....	<b>4</b> Vacuum Switch	.....

### INSTRUCTIONS FOR USING SUB-ROUTINE TESTS

Sub-routines are the following checks which are performed to correct a service code. Be sure to perform check as instructed. After replacing components or repairing circuits, repeat "Functional Test" and check engine operation.

Observe the following instructions when performing sub-routines:

- Do not measure voltage or resistance at MCU module, or connect test lamps to it (unless specific instructions say to do so).

- Disconnect both ends of a circuit when looking for continuity or shorts. Be sure ignition is turned off.
- Disconnect solenoids and switches from harness before measuring resistance or continuity.
- When more than one service code is indicated, start service with the first code received.
- Use wiring diagrams to locate pin locations and connectors.

**NOTE** — Complete system wiring diagrams are located before Sub-Routine Tests. Each test has a partial schematic to aid in servicing.

# 1a-62 1982 Computerized Engine Controls

## FORD MOTOR CO. MCU ENGINE CONTROL SYSTEM (Cont.)

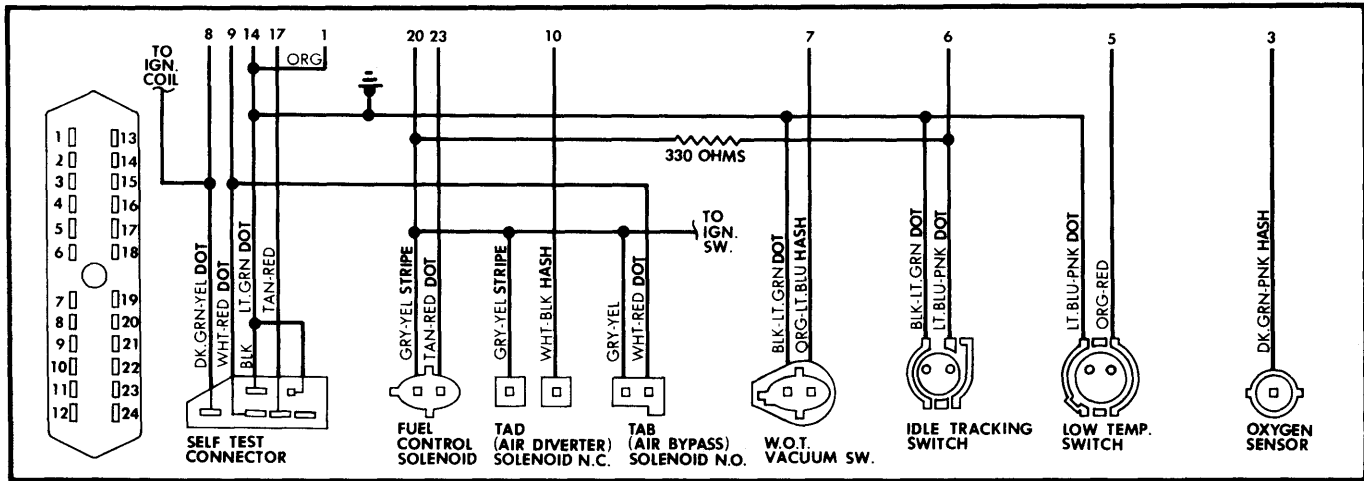

Fig. 4 4-Cylinder MCU System Wiring Diagram

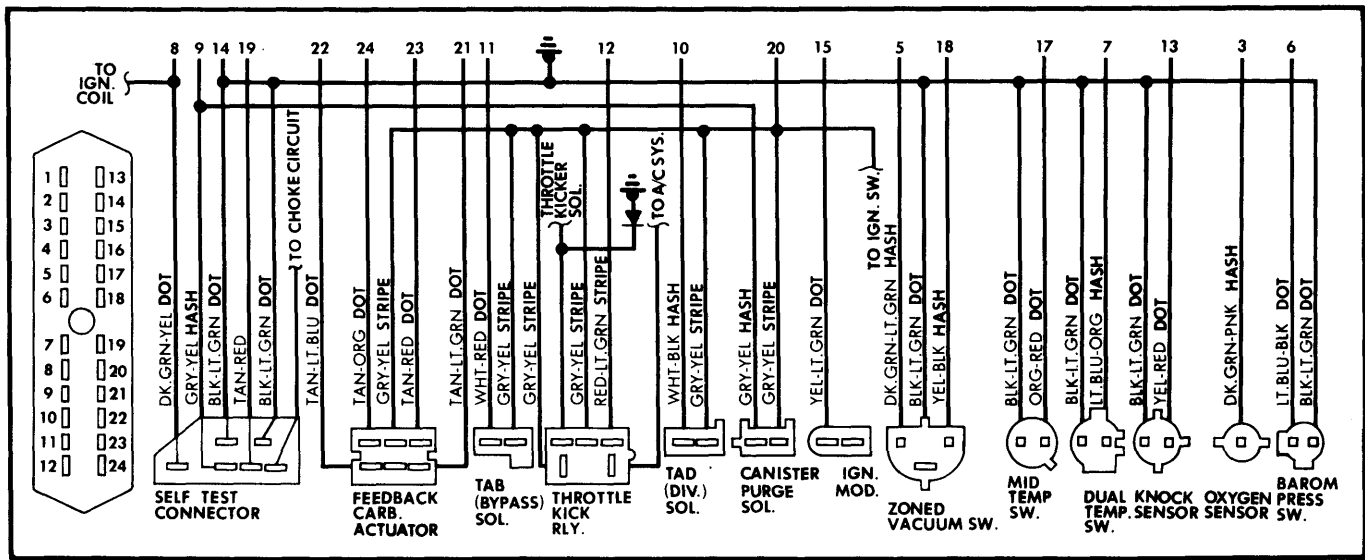

Fig. 5 V6 MCU System Wiring Diagram

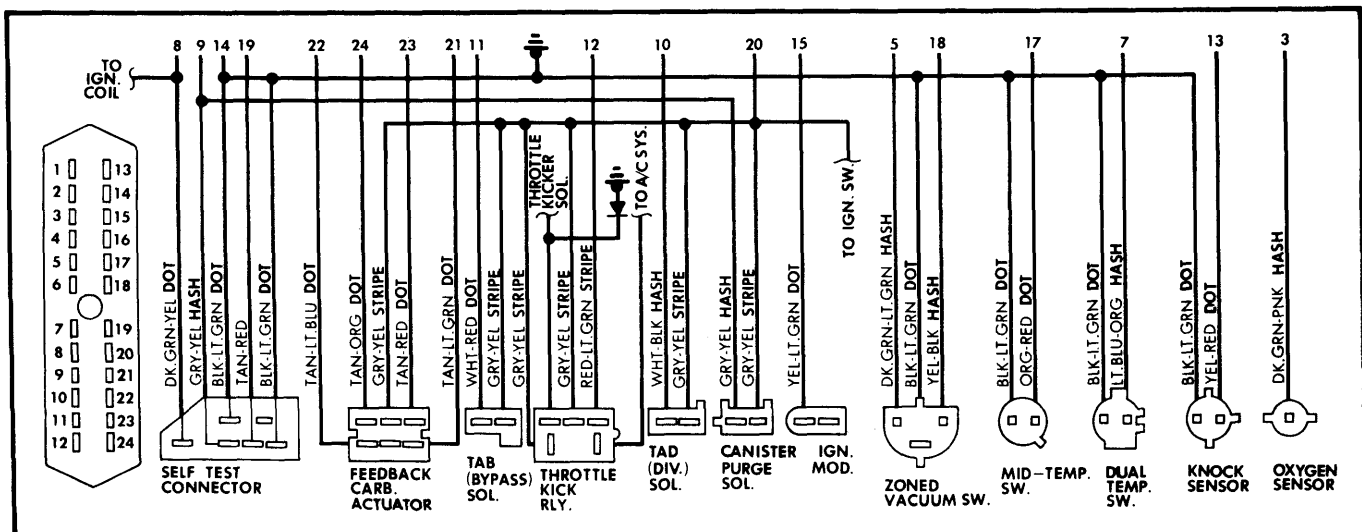

Fig. 6 V8 MCU System Wiring Diagram

# 1982 Computerized Engine Controls<sub>1a-63</sub>

## FORD MOTOR CO. MCU ENGINE CONTROL SYSTEM (Cont.)

### 4 & 6 CYLINDER (EXC. V6) SUB-ROUTINES

1

#### NO START TEST

This test detects faults in the MCU only.

1) Check Tach lead for a ground short. Leave harness connected to MCU; disconnect coil and ignition module connectors. Measure resistance between ground and self-test connector, then Tach connector. If resistance is less than 1000 ohms, go to step 2). If higher than 1000 ohms, MCU is not shorted.

2) Disconnect harness from MCU and measure resistance again. If resistance is less than 1000, repair circuit. If greater than 1000, replace MCU module.

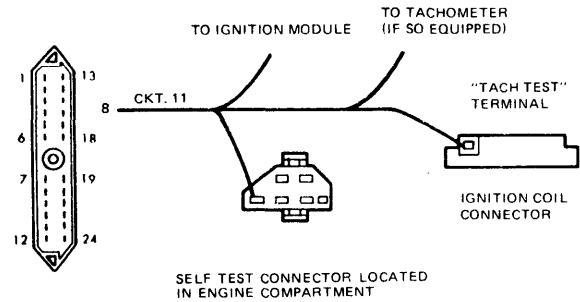

2

#### LOW TEMPERATURE SWITCH (CODE 51)

1) Ensure water temperature was above 95° F during Self-Test when code was observed.

2) Check contacts of low temperature switch (should be closed above 95° F). If resistance measures less than 5 ohms, go to step 3). If above 5 ohms, replace low temperature switch.

3) Measure resistance in wiring between MCU (pins 5 & 14) and low temperature switch. If resistance is less than 5 ohms, replace MCU module. If greater than 5 ohms, repair wiring.

4) Disconnect harness from low temperature switch and rerun "Functional Test". If service code other than 51 is recorded, go to appropriate test. If not, go to next step.

**NOTE** — The following steps are to be used when referred here by "Functional Test" Cold Drive Complaint procedure.

5) Check contacts of low temperature switch (should be open below 95° F). If resistance is greater than 5 ohms, go to next step. If less than 5 ohms, replace low temperature switch.

6) Check wire from pin 5 to switch for continuity with ground. Measure between pin 5 in MCU connector and ground. If resistance is less than 1000 ohms, repair circuit. If resistance is greater than 1000 ohms and code 51 still appears, replace MCU module.

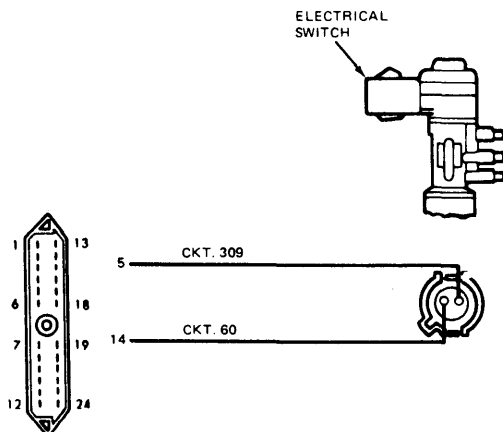

3

#### IDLE TRACKING SWITCH (CODES 52 & 62 4 Cyl. ONLY)

1) Ensure throttle was off fast idle cam and contacting Idle Tracking Switch (ITS) during "Functional Test" when code was observed.

2) Check switch contacts. Switch should be open when throttle is closed, and continuity should be present when throttle is partially open. If switch is okay, go to next step. If not, go to step 5).

3) Check continuity between MCU connector pin 6 and switch, and pin 14 and switch. Also, be sure wire between pin 6 and switch is not shorted to ground. If wiring is okay, go to next step. If not, repair circuit.

4) Be sure ignition is off, then disconnect wiring connectors from MCU and ITS. Measure resistance between pins 6 and 20 in MCU connector. If not within 280-380 ohm range, replace resistor. If resistance is correct, replace MCU module. Repeat "Functional Test".

5) Be sure ignition is off, then disconnect wiring connectors from MCU and ITS. Measure resistance between pins 6 and 20 in MCU connector. If not within 280-380 ohm range, replace resistor and ITS. If within range, replace only ITS. Repeat "Functional Test".

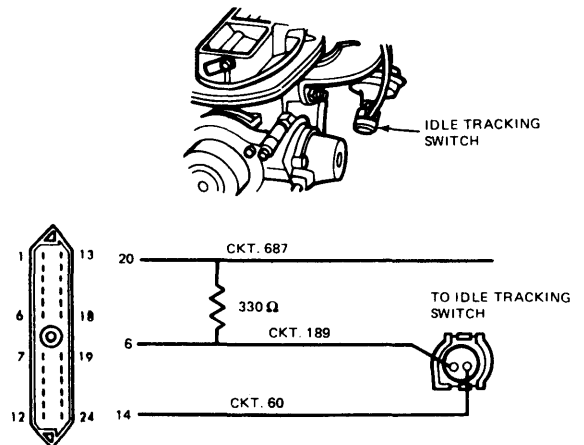

## FORD MOTOR CO. MCU ENGINE CONTROL SYSTEM (Cont.) 4 & 6 CYLINDER (EXC. V6) SUB-ROUTINES (Cont.)

### 4 VACUUM SWITCH

Use chart to identify code, switch, and pin connections. Use proper pin connection when directed by test procedures.

Code	Switch Name/Number	MCU Pin
4 Cylinder		
53 or 63	Wide Open Throttle #3	7
6 Cylinder		
52 or 62	Wide Open Throttle #2	6
53 or 63	Crowd #3	7
56 or 66	Closed Throttle #6	19

- 1) Verify correct amount of vacuum is present at switch (use vacuum gauge). At least 8 in. Hg at switches 2 and 3; at least 20 in. Hg at switch 6. Check switch 6 at 2500 RPM; all others at idle. If vacuum level is too low, check vacuum lines and thermal switches. If vacuum is okay, go to next step.
- 2) Check switch contacts. Continuity should be present without vacuum. If resistance is greater than 5 ohms, replace vacuum switch. If less than 5 ohms, go to next step.
- 3) Check switch contacts with vacuum applied to switch (at least 20 in. Hg). If resistance is less than 5 ohms, replace vacuum switch. If greater than 5 ohms, go to next step.
- 4) Check continuity from pin 14 in MCU connector to bottom pin in 2-wire connector at vacuum switch (circuit 60). If resistance is less than 5 ohms, go to next step. If greater than 5 ohms, repair wiring.
- 5) Check continuity of switch circuit from MCU connector to switch. Use MCU pin identified in chart, and switch connector pin identified in wiring diagram at end of test. If resistance is greater than 5 ohms, repair circuit. If less than 5 ohms, go to next step.
- 6) Check same circuit for short to ground. Measure between MCU pin and ground. If resistance is less than 1000 ohms, repair short in circuit. If greater than 1000 ohms, MCU module must be replaced.

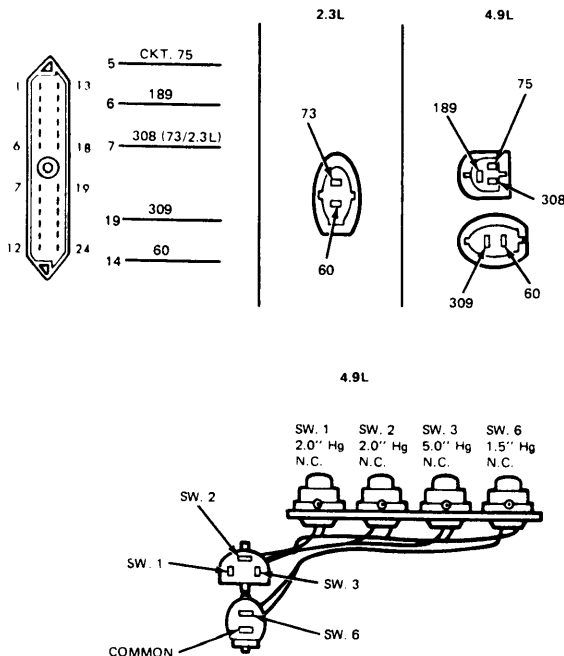

### 5 LOW TEMPERATURE VACUUM SWITCH (CODE 51 6 CYL. ONLY)

- 1) Check vacuum switch contacts without vacuum applied. Measure resistance across switch. If less than 5 ohms, go to next step. If greater than 5 ohms, replace switch.
  - 2) Vacuum at switch should be less than 1 in. Hg with engine hot. If vacuum is too high, replace PVS. If vacuum level is correct, go to next step.
  - 3) Check continuity between switch connector pins and MCU connector pins 5 and 14. If resistance is greater than 5 ohms, repair circuit. If less than 5 ohms and code is still present after "Functional Test", replace MCU module.
- NOTE** - The following steps are to be used when referred here by "Functional Test" Cold Drive Complaint procedure.
- 4) Disconnect harness from vacuum switch and repeat "Functional Test" section that produced code 51. If another code appears, go to step 8). If code 51 reappears, go to next step.
  - 5) Apply more than 4 in. Hg to switch. Measure resistance to be sure contacts are open. If resistance is less than 5 ohms, replace switch. If greater than 5 ohms, go to next step.
  - 6) Ensure that vacuum is present at vacuum switch when coolant is below 95° F. If vacuum is present, MCU is okay. Check for other problems. If no vacuum, go to next step.
  - 7) Check vacuum hoses for blockage or leaks, and check PVS for proper operation. Repair problems as necessary. If vacuum leak or block is not found, MCU is okay, check for other problems.
  - 8) Check resistance between MCU connector pin 5 and ground. If less than 1000 ohms, repair short to ground. If higher than 1000 ohms, replace MCU module.

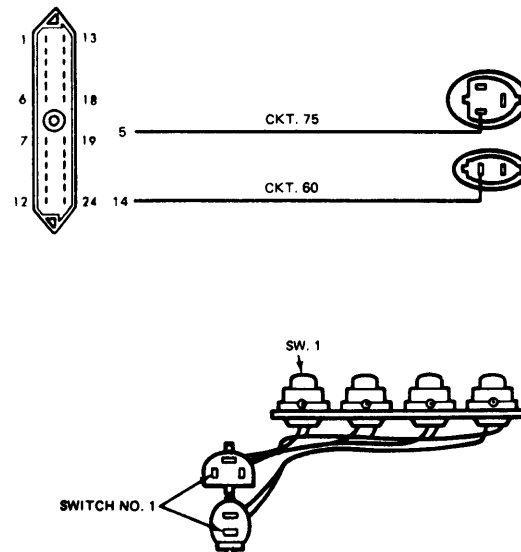

# 1982 Computerized Engine Controls<sub>1a-65</sub>

## FORD MOTOR CO. MCU ENGINE CONTROL SYSTEM (Cont.) 4 & 6 CYLINDER (EXC. V6) SUB-ROUTINES (Cont.)

6

### FUEL ALWAYS LEAN (CODE 41 4 CYL. ONLY)

After starting engine, allow at least 2 minutes at idle before testing. Disconnect "Functional Test" trigger jumper. Do not block throttle open as Idle Tracking Switch will be activated and invalidate test.

- 1) Disconnect MCU connector and oxygen sensor. Turn all accessories off. Measure resistance between ground and MCU connector pins 3 and 23. If resistance is less than 1000 ohms in either case, repair short. If resistance is greater than 1000 ohms, go to next step.
- 2) Check continuity between MCU connector pin 1 and ground, then between pin 3 and oxygen sensor connector (harness side). If resistance is greater than 5 ohms, repair short. If less than 5 ohms, go to next step.
- 3) Check vent hose between Fuel Control Solenoid and carburetor. If blocked, blow clear. If not blocked, go to next step.
- 4) Reconnect MCU and oxygen sensor. Disconnect harness from Fuel Control Solenoid (FCS). Connect a vacuum gauge (using "T") to hose between FCS middle port and carburetor feedback port. Idle engine at least 15 seconds. If vacuum is greater than 2 in. Hg, replace FCS. If less than 2 in. Hg, go to next step.
- 5) Move vacuum gauge to feedback port of carburetor and "T" into hose. Run engine at 2500 RPM and observe vacuum level. If greater than 2.5 in. Hg, replace MCU module. If less than 2.5 in. Hg, go to next step.
- 6) Disconnect Thermactor air supply hose at pump and plug hose. Set RPM at 2500 and hold choke 3/4 closed to force system rich. With vacuum gauge still connected at carburetor feedback port, observe vacuum after 15 seconds. If less than 2.5 in. Hg, go to next step. If greater than 2.5 in. Hg, MCU is okay. Check mixture adjustment and Thermactor system.
- 7) Turn engine off. Disconnect oxygen sensor connector and check resistance between harness side of connector and ground. If resistance is less than 1000 ohms, replace MCU module. If greater than 1000 ohms, go to next step.
- 8) With oxygen sensor still disconnected, start engine. With engine idling, connect a jumper wire to harness side of oxygen sensor connector. Be sure this connection cannot contact ground. Connect the other end of jumper to battery positive terminal, then raise engine speed to 2500-2800 RPM. If vacuum is less than 2.5 in. Hg, replace MCU module. If greater than 2.5 in. Hg, replace oxygen sensor.

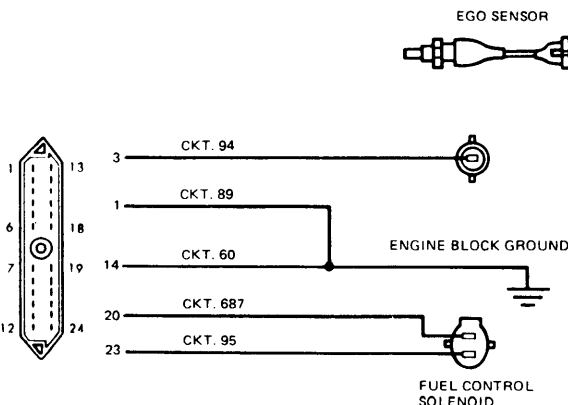

7

### FUEL ALWAYS RICH (CODE 42 4 CYL. ONLY)

After starting engine, allow at least 2 minutes at idle before testing. Disconnect "Functional Test" trigger jumper. Do not block throttle open as Idle Tracking Switch will be activated and invalidate test.

- 1) Check choke valve for sticking or binding and repair as necessary.
  - 2) Disconnect MCU connector and connector at Fuel Control Solenoid (FCS). Measure resistance between MCU pin 20 and FCS connector, then between MCU pin 23 and FCS connector. Resistance in both wires should be less than 5 ohms. If so, go to next step. If resistance is higher, repair wiring.
  - 3) Check vacuum lines from manifold vacuum to FCS, then hose from FCS to feedback carburetor. If leaks or blocks are found, repair as necessary. If vacuum lines are okay, go to next step.
  - 4) Disconnect vacuum hose from feedback port at carburetor, then connect a vacuum gauge to hose. Start engine and run at 2500 RPM. After 15 seconds, check vacuum level. If less than 2.5 in. Hg, go to next step. If greater than 2.5 in. Hg, go to step 7).
  - 5) Check resistance of Fuel Control Solenoid. If within 30-65 ohms, go to next step. If resistance is not within 30-65, replace FCS.
  - 6) Connect vacuum gauge to feedback hose at carburetor. Energize FCS by connecting jumper wires to ground and battery. At idle, 4-6 in. Hg should be present on gauge. If so, replace MCU module. If not, replace FCS.
- CAUTION** — For the following step, a digital VOM must be used which has an input impedance of at least 10 megohms.
- 7) Disconnect oxygen sensor from harness. Connect DVOM between sensor and ground, with switch in lowest voltage position. Start engine and run at 2000 RPM for 1 minute to warm up sensor. Turn engine off and immediately check DVOM reading. If greater than 0.4 volts, go to next step. If less than 0.4 volts, check carburetor (too rich).
  - 8) Purge exhaust system by immediately disconnecting coil "horseshoe" connector and cranking engine for 10 seconds with throttle wide open. Observe DVOM. If greater than 0.4 volts, replace oxygen sensor. If less than 0.4 volts, check carburetor (too rich).

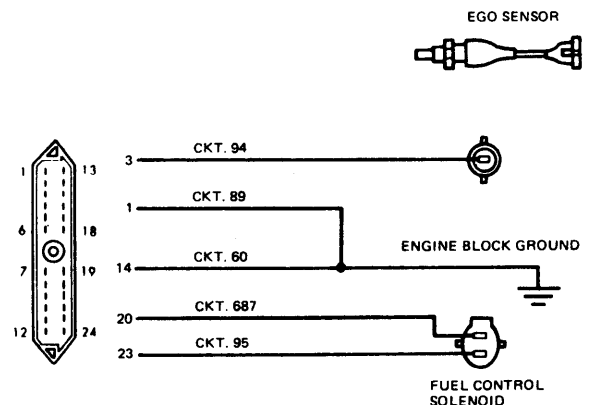

## FORD MOTOR CO. MCU ENGINE CONTROL SYSTEM (Cont.)

### 4 & 6 CYLINDER (EXC. V6) SUB-ROUTINES (Cont.)

8

#### FUEL ALWAYS LEAN (CODE 41 6 CYL. ONLY)

After starting engine, allow at least 40 seconds before testing. Disconnect "Functional Test" trigger jumper.

- 1) Disconnect oxygen sensor and MCU connector. Turn all accessories off. Check resistance between MCU connector pin 3 and ground, then pin 23 and ground. If resistance in either circuit is less than 1000 ohms, repair short to ground. If resistance is greater than 1000 ohms, go to next step.
- 2) Check continuity between pin 1 of MCU connector and ground, then continuity between pin 3 and oxygen sensor connector. If either circuit measures more than 5 ohms, repair wiring. If both are less than 5 ohms resistance, go to next step.
- 3) Connect voltmeter to back of Fuel Control Solenoid (FCS) connector. Start engine and run at 2500 RPM. Observe voltage after 15 seconds. If less than 10 volts, go to next step. If greater than 10 volts, replace MCU module.
- 4) Reconnect oxygen sensor and MCU connector. Disconnect Thermactor hose from air pump and plug hose. Set engine at 2500 RPM and hold choke valve 3/4 closed to force engine rich. With voltmeter still connected at FCS, observe voltage after 15 seconds. If less than 10 volts, go to next step. If greater than 10 volts, MCU is okay. Check Thermactor and carburetor.
- 5) Turn ignition off and disconnect harness from oxygen sensor. Measure resistance between oxygen sensor wire (harness side) and ground. If resistance is less than 1000 ohms, replace MCU module. If greater than 1000 ohms, go to next step.
- 6) With oxygen sensor still disconnected, start engine. With engine idling, connect a jumper wire to harness side of oxygen sensor connector. Be sure this connection cannot touch ground. Connect other end of jumper to battery positive terminal, then raise engine speed to 2500-2800 RPM. If voltage at FCS is less than 10 volts, replace MCU module. If greater than 10 volts, replace oxygen sensor.

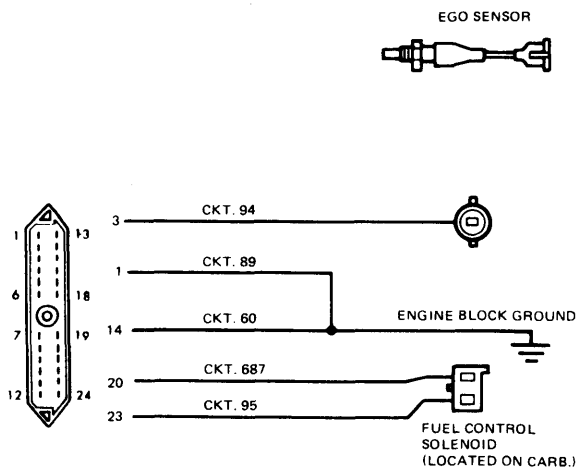

9

#### FUEL ALWAYS RICH (CODE 42 6 CYL. ONLY)

After starting engine, allow at least 40 seconds before testing. Disconnect "Functional Test" trigger jumper.

- 1) Check choke valve for sticking or binding, and repair as necessary.
- 2) Disconnect connector at MCU and connector at Fuel Control Solenoid (FCS). Measure resistance between pin 20 in MCU connector and 1 pin at FCS connector, then between pin 23 at MCU connector and other pin at FCS connector. Resistance should be less than 5 ohms in both cases. If not, repair wiring. If okay, go to next step.
- 3) Check resistance across terminals of FCS. If within 15-33 ohms, go to next step. If not, replace FCS.
- 4) Connect a voltmeter to the back of FCS connector. Start engine and run at 2500 RPM. Check voltage after 15 seconds. If less than 10 volts, replace MCU module. If greater than 10 volts, go to next step.

**CAUTION** — For the following step, a digital VOM must be used which has an input impedance of at least 10 megohms.

- 5) Disconnect oxygen sensor and connect DVOM between sensor and ground, with switch in lowest voltage position. Start engine and run at 2000 RPM for 1 minute to warm up sensor. Turn engine off and immediately check DVOM reading. If greater than 0.4 volts, go to next step. If less than 0.4 volts, check carburetor (too rich).
- 6) Purge exhaust system immediately by disconnecting coil "horseshoe" connector and cranking engine for 10 seconds with throttle wide open. Observe voltage reading. If greater than 0.4 volts, replace oxygen sensor. If less than 0.4 volts, check carburetor (too rich).

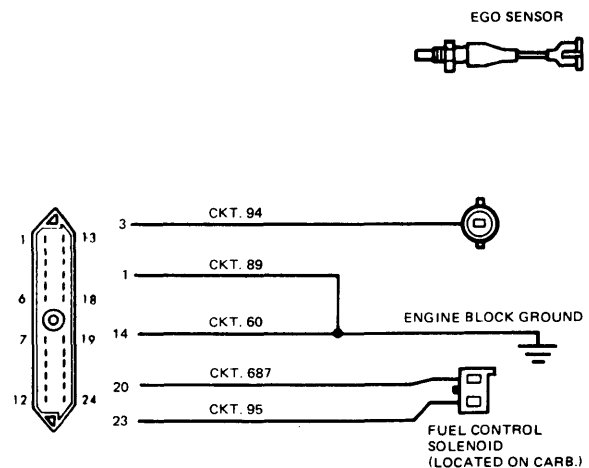

# 1982 Computerized Engine Controls 1a-67

## FORD MOTOR CO. MCU ENGINE CONTROL SYSTEM (Cont.) 4 & 6 CYLINDER (EXC. V6) SUB-ROUTINES (Cont.)

10

### THERMACTOR SYSTEM (CODE 44)

**2.3L 4-Cyl. with Man. Trans. Only** - 1) With engine running at curb idle, remove vacuum hose from vacuum switch. If no vacuum is present at hose, check vacuum hose for blockage or leakage. If vacuum is present, proceed to next step.

2) Turn engine off. Remove harness connector from vacuum switch. Measure resistance at vacuum switch contacts. If resistance is less than 100,000 ohms, replace switch. If resistance is greater than 100,000 ohms, proceed to next step.

3) Tee a vacuum gauge into hose going to vacuum switch. Apply at least 20 in. Hg of vacuum. Measure resistance at vacuum switch. If resistance is greater than 5 ohms, replace switch. If resistance is less than 5 ohms, proceed to next step.

4) Check circuit 60 for continuity. Measure resistance from switch to engine ground. If resistance is greater than 5 ohms, service or replace wire from switch to engine ground. If resistance is less than 5 ohms, proceed to next step.

5) Check circuit 200 for continuity by measuring resistance from vacuum switch to module connector pin 10. If resistance is greater than 5 ohms, service or replace wire from vacuum switch to module connector. If resistance is less than 5 ohms, proceed to next step.

6) Check circuit 200 for a short to ground by measuring resistance from vacuum switch to ground. If resistance is less than 1,000 ohms, service or repair circuit 200. If resistance is greater than 1,000 ohms, proceed to step 1) for all models.

**All Models** - 1) Remove vacuum hose from TAB valve and connect gauge to hose. Start engine and raise RPM to above 2500 to activate "Function Test" and observe vacuum gauge. If vacuum pulses are above and below 5 in. Hg, proceed to next step. If pulses are always above 5 in. Hg, proceed to step 7) (4-Cyl.) or next step (6-Cyl.). If pulses are below 5 in. Hg, proceed to next step (4-Cyl.) or to step 10) (6-Cyl.).

2) Reconnect hose to TAB. Disconnect hose at TAD valve and connect vacuum gauge. Start engine and raise speed above 2500 RPM to start "Functional Test". Observe vacuum readings. If above and below 5 in. Hg, go to next step. If always above 5 in. Hg, go to step 14) (4 Cyl.) or next step (6 Cyl.). If pulses are always below 5 in. Hg, go to step 16) (4 Cyl.) or next step (6 Cyl.).

3) Reconnect hose to TAD valve. Remove upstream air hose at TAD valve. Start engine and raise RPM above 2500 to start "Functional Test". Hold engine speed and feel for air at TAD valve nipple 20 seconds after test starts. Air will flow for 6 seconds. If okay, go to next step. If not, check air pump.

4) Turn engine off and reconnect air hose. Disconnect harness from oxygen sensor and insert jumper wire between connector and ground. Start engine, raise RPM to begin "Functional Test" and maintain RPM until output code is received. If code 41 is read on voltmeter, check choke system, then go to next step. If code 44 is received, replace MCU module.

**CAUTION** - For the next step, a digital VOM must be used which has an input impedance of at least 10 megohms.

5) Place DVOM selector in lowest voltage position and connect it between oxygen sensor and ground. Start engine and run at 2000 RPM for 1 minute to warm up sensor. Turn engine off and immediately check DVOM. If voltage is less than 0.4 volts, check carburetor (too rich). If voltage is greater than 0.4 volts, go to next step.

6) Immediately purge exhaust system. Disconnect coil "horseshoe" connector and crank engine for 10 seconds with throttle wide open. If voltage is greater than 0.4 volts, replace oxygen sensor. If voltage is less than 0.4 volts, check carburetor (too rich).

7) Disconnect MCU connector, then connectors at TAD and TAB solenoids. Check continuity between MCU connector pin 20 and TAD solenoid, then

between pin 9 (4 Cyl.) or 11 (6 Cyl.) and TAB solenoid. If less than 5 ohms resistance, go to next step. If greater than 5 ohms resistance is measured, repair wiring.

8) Measure resistance of TAB solenoid. If between 50-110 ohms, go to next step. If not within 50-110 ohms, replace TAB solenoid.

9) Check at TAB solenoid output to be sure vacuum is not present when solenoid is energized (12 volts). If vacuum is present, replace TAB solenoid. If no vacuum, replace MCU module.

10) Check vacuum hose between TAD and TAB solenoid, then between source and TAB solenoid. Repair as necessary. If hoses are okay, go to next step.

11) Check vacuum switch (TVS) and retard delay valve (RDV) for proper installation and operation. Check vacuum schematic for usage and location. Service valves if necessary, otherwise go to next step.

12) Check at TAB solenoid output to be sure vacuum is present when the solenoid is energized (12 volts). If vacuum is not present, replace TAB solenoid. If vacuum is present, go to next step.

13) Disconnect TAB solenoid connectors and MCU connector. Measure resistance between pin 20 and TAB connector, then pin 11 and TAB solenoid. If resistance is less than 5 ohms, replace MCU module. If higher than 5 ohms, repair circuits.

14) Disconnect MCU connector. Measure resistance from pin 20 to ground. If greater than 1000 ohms, go to next step. If less than 1000 ohms, repair short to ground.

15) Check at TAD solenoid to be sure vacuum is not present when solenoid is deactivated. If vacuum is present, replace TAD solenoid. If vacuum is not present, replace MCU module.

16) Check vacuum hoses between TAD valve and TAD solenoid, then between TAD solenoid and vacuum source. Repair if necessary. If vacuum source and hoses are okay, go to next step.

17) Check retard delay valve (RDV) for proper installation and operation. Check thermal vacuum switch (TVS) for proper installation and operation (if used on vehicle). Replace if necessary. If okay, go to next step.

18) Measure resistance of TAD solenoid. If not between 50-110 ohms, replace solenoid. If resistance is okay, go to next step.

19) Check at TAD solenoid to be sure vacuum is present when solenoid is energized (12 volts). If vacuum is not present, replace solenoid. If vacuum is present, go to next step.

20) Disconnect wiring at TAD solenoid and MCU. Measure between MCU pin 20 and TAD solenoid, then between pin 10 and solenoid. If resistance is greater than 5 ohms, repair wiring. If less than 5 ohms, replace MCU module.

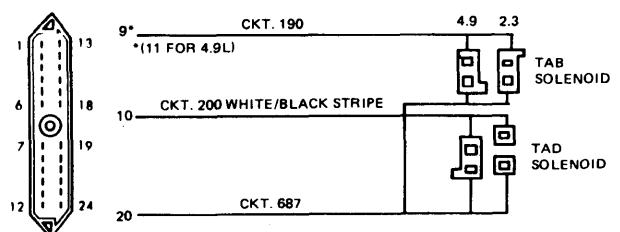

FORD MOTOR CO. MCU ENGINE CONTROL SYSTEM (Cont.)  
4 & 6 CYLINDER (EXC. V6) SUB-ROUTINES (Cont.)

11 THERMACTOR AIR DIVERTER (CODE 45)

- 1) Remove vacuum hose from TAD valve and connect vacuum gauge to hose. Start engine and raise speed to 2500 RPM to begin "Functional Test". Observe gauge during initial pulses. If pulses are above and below 5 in. Hg, MCU is okay - check ThermaCTOR pump. If pulses are always above 5 in. Hg, check ThermaCTOR pump (4 Cyl.) or go to step 6) (6 Cyl.). If pulses are always below 5 in. Hg, go to next step (4 Cyl.) or check ThermaCTOR pump (6 Cyl.).
- 2) Check vacuum hoses between vacuum source, TAD solenoid, and TAD valve. If vacuum source or hoses are faulty, repair. If okay, go to next step.
- 3) Measure resistance of TAD solenoid. If within 50-110 ohms, go to next step. If not, replace TAD solenoid.
- 4) Check at TAD solenoid output for vacuum when solenoid is energized (12 volts). If no vacuum, replace solenoid. If vacuum is present, go to next step.
- 5) Disconnect MCU connector and TAD connector. Measure resistance between MCU pin 10 and TAD connector, then between pin 20 and TAD connector. If resistance is less than 5 ohms, replace MCU module. If resistance is greater than 5 ohms, repair circuit.
- 6) Check at TAD solenoid output to ensure vacuum is not present when solenoid is deactivated. If vacuum is present, replace solenoid. If no vacuum, go to next step.
- 7) Measure resistance between MCU pin 10 and ground. If resistance is less than 1,000 ohms, replace MCU module. If resistance is greater than 1,000 ohms, repair short circuit to ground.

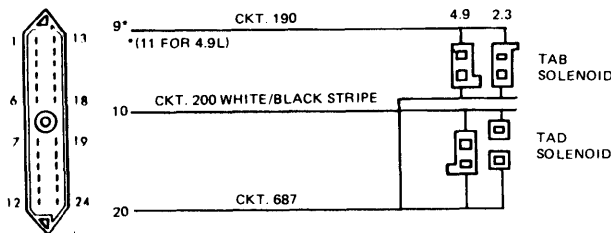

12 THERMACTOR AIR BY-PASS (CODE 46)

- 1) Remove vacuum hose at TAB valve and connect gauge to hose. Start engine and raise speed above 2500 RPM to start "Functional Test". Observe gauge during initial pulses. If pulses are above and below 5 in. Hg, MCU is okay - check ThermaCTOR pump. If pulses are always above 5 in. Hg, check ThermaCTOR pump (4 Cyl.) or go to step 5) (6 Cyl.). If pulses are always below 5 in. Hg, go to next step (4 Cyl.) or check ThermaCTOR pump (6 Cyl.).
- 2) Check vacuum hoses between vacuum source, TAB solenoid, and TAB valve for leaks or blockage. Repair if necessary. If hoses are okay, go to next step.
- 3) Check at TAB solenoid output to be sure vacuum is present when solenoid is deactivated. If no vacuum is present, replace solenoid. If vacuum is present, go to next step.
- 4) Disconnect MCU and TAB solenoid connectors. Measure resistance between ground and MCU pin 9. If resistance is less than 1000 ohms, repair short to ground. If resistance is greater than 1000 ohms, replace MCU module.
- 5) Check TAB solenoid output to make sure vacuum is not present when solenoid is deactivated. If vacuum is present, replace solenoid. If vacuum is not present, go to next step.
- 6) Disconnect MCU and TAB solenoid connectors. Measure resistance between ground and MCU pin 11. If resistance is less than 1000 ohms, repair short to ground. If greater than 1000 ohms, replace MCU module.

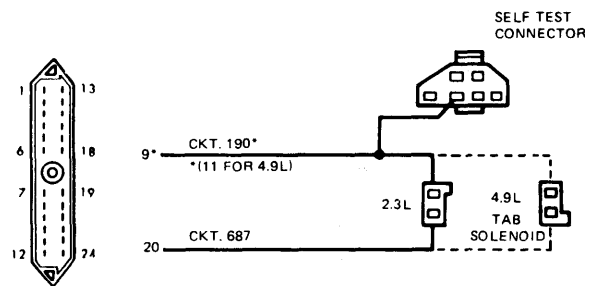

13 RUNNING TEST NOT INITIATED (CODE 33)

It is necessary to increase speed to more than 2500 RPM within 20 seconds after start in order to initiate "Functional Test". Turn key off and repeat procedure.

14 FUNCTIONAL TEST NOT OPERATING

- 1) Ensure that test connections, jumper wires, and VOM were all correctly hooked up.
- 2) Disconnect MCU connector. With ignition on, battery voltage should be present at pin 20. If not, check fuse. With ignition off, pin 14 should have continuity to ground. If not, repair. If wiring is okay, go to next step.
- 3) Check for continuity between Self-Test connector and MCU. See wiring diagram at end of this test for wire connections. Check to ensure circuit from MCU to TAB solenoid is not shorted to ground.
- 4) Measure TAB solenoid resistance. If within 50-110 ohms, replace MCU module. If not within 50-110 ohms, replace solenoid. Repeat "Functional Test".

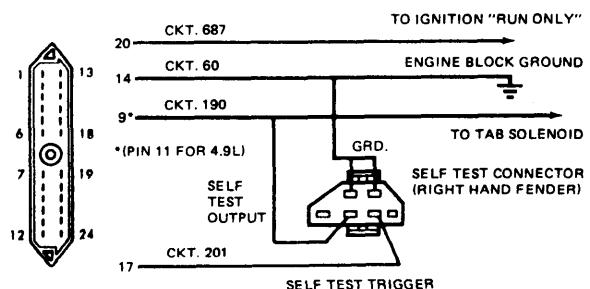

# 1982 Computerized Engine Controls<sub>1a-69</sub>

## FORD MOTOR CO. MCU ENGINE CONTROL SYSTEM (Cont.)

### 4 & 6 CYLINDER (EXC. V6) SUB-ROUTINES (Cont.)

15

#### TACHOMETER LEAD

Disconnect MCU connector and "horseshoe" connector at ignition coil. Check continuity between pin 8 in MCU connector and "Tach Test" terminal in coil connector. If circuit is open, repair. If continuity is found, replace MCU module.

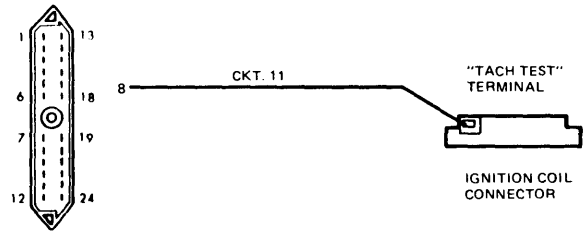

16

#### CANISTER PURGE SOLENOID (6 CYL. ONLY)

- 1) Check vacuum hoses for leaks and blockage. Check vacuum source. Repair as necessary.
- 2) Check to ensure Canister Purge solenoid passes vacuum when energized (12 volts) and blocks vacuum when deactivated. If solenoid does not operate as indicated, replace. If solenoid operates correctly, go to next step.
- 3) Disconnect connectors at MCU and Canister Purge solenoid. Check continuity between MCU pin 12 and solenoid connector, then pin 20 and solenoid connector. If resistance is less than 5 ohms, go to next step. If more than 5 ohms, repair open circuit.
- 4) Measure resistance between MCU pin 12 and ground. If resistance is less than 1000 ohms, repair short to ground. If greater than 1000 ohms, replace MCU module.

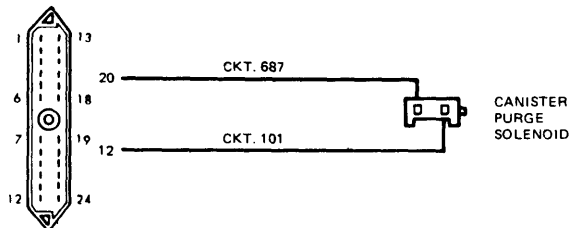

17

#### 17 SPARK RETARD SOLENOID (6 CYL. ONLY)

- 1) Check vacuum hoses for leaks or blockage, then check vacuum source at 2500 RPM. Repair or clean as necessary.
- 2) Hold engine at 2000 RPM. Make sure vacuum is present at Spark Retard Solenoid output when solenoid is activated (12 volts) and no vacuum present when deactivated. If solenoid does not operate properly, replace it. If operation is okay, go to next step.
- 3) Disconnect MCU connector and Spark Retard Solenoid connector. Measure resistance between MCU pin 20 and solenoid connector, then pin 9 and solenoid connector. If resistance is more than 5 ohms, repair wiring. If less than 5 ohms, go to next step.
- 4) Measure resistance between MCU connector pin 9 and ground. If resistance is less than 1000 ohms, repair short to ground. If greater than 1000 ohms, replace MCU module.

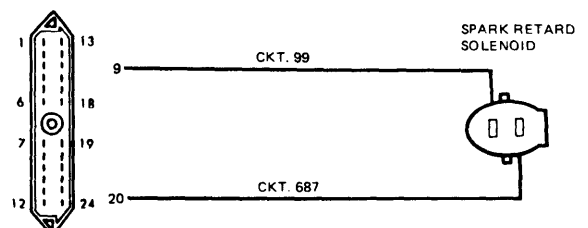

### V6 & V8 SUB-ROUTINES

18

#### NO START TEST

This test identifies faults in the MCU only, not other causes of No-Start condition.

- 1) Turn ignition off. Disconnect coil "horseshoe" shaped connector from coil, and vehicle harness from ignition module (4-wire connector). Check resistance between coil connector "Tach Test" terminal and ground. If resistance is less than 1000 ohms, go to next step. If greater than 1000 ohms, MCU is okay.
- 2) Disconnect vehicle harness connector at MCU. Measure resistance between pin 8 and ground. If greater than 1000 ohms, replace MCU module. If less than 1000 ohms, repair circuit from MCU module to coil connector to ignition module connector.

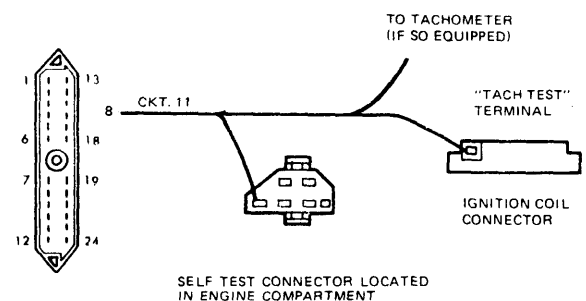

# 1a-70 1982 Computerized Engine Controls

## FORD MOTOR CO. MCU ENGINE CONTROL SYSTEM (Cont.)

### V6 & V8 SUB-ROUTINES (Cont.)

19

#### ELECTRICAL TEMPERATURE SWITCH OPEN (CODE 53 & 54)

Code 53 is for Dual Temperature Switch, code 54 is for Mid-Temperature Switch. Before testing, ensure temperature of coolant is between 140-200° F.

1) Disconnect vehicle harness from switch. Connect ohmmeter across switch terminals and measure resistance. If resistance is greater than 10 ohms, replace switch. If less than 10 ohms, go to next step.

2) Disconnect MCU harness connector. Check continuity of circuits from MCU connector to switch connector. (Pins 7 & 14 for Dual-Temp. Switch; pins 14 & 17 for Mid-Temp Switch). If resistance is greater than 10 ohms, repair circuit. If less than 10 ohms, replace MCU module.

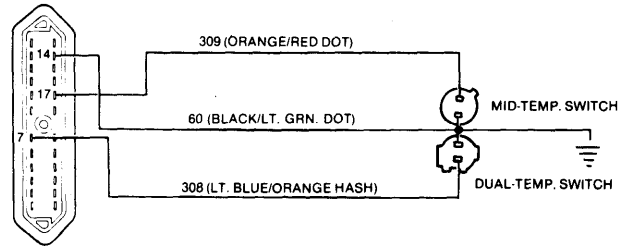

20

#### VACUUM SWITCH OPEN (CODES 51 & 55)

Code 51 is for Hi/Low Vacuum Switch, code 55 for Mid Vacuum Switch. Use steps 1) and 2) for code 51, and steps 3) through 5) for code 55. Be sure vacuum is present at switch during idle conditions.

1) Turn ignition off. Disconnect switch from harness. Measure resistance across Hi/Low Vacuum Switch by inserting ohmmeter probes into switch connector. If resistance is less than 5 ohms, go to next step. If resistance is greater than 5 ohms, replace switch.

**NOTE** — Not all calibrations use a Hi Vacuum Switch.

2) Disconnect MCU harness connector. Measure continuity from MCU connector pin 5 to switch connector (Dk Grn/Lt Grn), then measure from pin 14 to switch connector (Blk/Lt Grn). If resistance is 5 ohms or less, replace MCU module. If greater than 5 ohms, repair circuits.

3) Start engine and run at idle. Disconnect Mid Vacuum Switch hose. Check for manifold vacuum at hose. If vacuum exists, go to next step. If not, check hose for plugs, leaks, or wrong connections.

4) Turn ignition off. Disconnect vehicle harness from switch connector. Apply a minimum of 15 in. Hg vacuum to switch. Check resistance of switch. If resistance is less than 5 ohms, reconnect hose and proceed to next step. If resistance is greater than 5 ohms, replace switch assembly.

5) Disconnect MCU harness connector. Measure continuity from MCU connector pin 18 to switch connector (Yel/Blk), then measure from pin 14 to switch connector (Blk/Lt Grn). If resistance is less than 5 ohms, replace MCU module. If resistance is greater than 5 ohms, repair circuit.

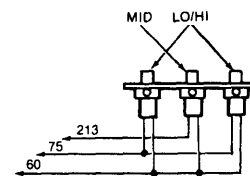
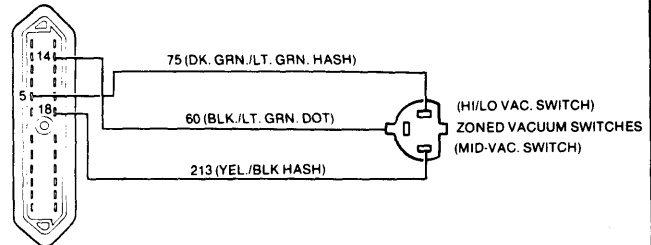

21

#### VACUUM SWITCH CLOSED (CODE 65)

Ensure that vacuum hoses are connected to switch and engine coolant is between 140-200° F.

1) Turn engine and ignition off and disconnect vacuum switch from vehicle harness. Connect ohmmeter across switch connector to measure switch resistance. If resistance is greater than 1000 ohms, reconnect switch. If less than 1000 ohms replace switch assembly.

2) Disconnect vehicle harness from MCU. Connect ohmmeter between MCU connector pin 18 and engine ground. If resistance is greater than 1000 ohms, replace MCU. If less than 1000 ohms, repair circuits.

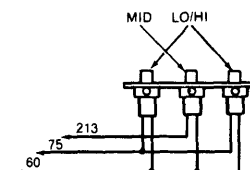
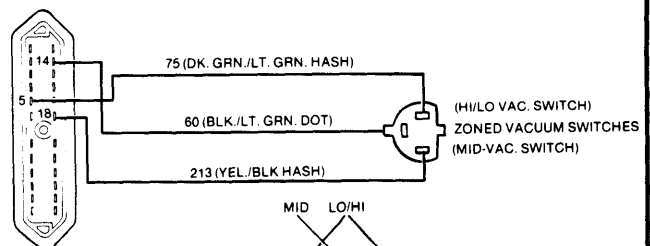

## FORD MOTOR CO. MCU ENGINE CONTROL SYSTEM (Cont.)

### V6 & V8 SUB-ROUTINES (Cont.)

22

#### FUEL ALWAYS LEAN (CODE 41)

Run engine at 2000 RPM for 1 minute, then retest to ensure code still appears. If code still appears, disconnect jumper wire from Self-Test connector and proceed.

**CAUTION** — To prevent damage to the oxygen sensor, never connect ohmmeter to the sensor. Use DVOM with more than 10 megohms input impedance.

- 1) Turn ignition off. Disconnect oxygen sensor, then connect a jumper wire from oxygen sensor to vehicle harness. Connect DVOM between engine block and jumper wire. Start engine and run at 2000-2300 RPM while applying 9-18 in. Hg to vacuum switch assembly. Wait 2 minutes, then check voltmeter. If voltage remains below 0.5 volts, go to next step. If voltage remains above 0.5 volts, go to step 4). If voltage alternates above and below 0.5 volts, go to step 12).
- 2) Reconnect oxygen sensor to vehicle harness, then disconnect Thermactor air hose at pump. Disconnect MCU connector and connect DVOM between MCU connector pin 3 and engine ground. Place carburetor on high idle cam, then depress CVR rod on top of carburetor to force system rich. If voltage is less than 0.5 volts, go to next step. If greater than 0.5 volts, go to step 5).
- 3) Turn ignition off. Disconnect oxygen sensor from vehicle harness (leaving MCU still disconnected). Connect ohmmeter between MCU connector pin 3 and ground. Do not touch metal portion of leads while making measurement. If ohmmeter shows an open circuit, replace oxygen sensor. If resistance is less than 190,000 ohms, repair circuit.
- 4) With ignition off, disconnect MCU harness connector and oxygen sensor. Connect ohmmeter to oxygen sensor connector (vehicle harness side) and MCU connector pin 3. If resistance is less than 10 ohms, replace MCU module. If greater than 10 ohms, repair circuit.
- 5) Reconnect all wiring, then start engine and run on low step of fast idle cam. Disconnect harness from feedback (FBCA) motor on carburetor. Let engine run 2 minutes, then apply at least 15 in. Hg vacuum to zone switch assembly. Connect a known good feedback motor (with shaft fully depressed) to vehicle harness. While observing motor shaft, disconnect PCV hose from carburetor. If shaft does not extend, go to next step. If shaft extends in 10-15 seconds, reconnect PCV and Thermactor hoses and go to step 8).
- 6) Turn ignition off. Disconnect MCU harness connector and feedback motor connector. Use an ohmmeter to check continuity of circuits from feedback connector to MCU connector. If resistance is more than 10 ohms in any circuit, repair circuit. If less than 10 ohms in all circuits, go to next step.
- 7) Connect 1 ohmmeter lead to engine ground. Check all circuits in feedback connector (except Gray/Yellow) for continuity with ground. If resistance is more than 1000 ohms in all circuits, go to next step. If not, repair circuit.
- 8) With ignition off, connect ohmmeter lead to feedback (FBCA) motor case and other lead to center pin (directly below blank space) of motor. If resistance is less than 190,000 ohms, replace motor. If greater than 190,000 ohms, go to next step.
- 9) Remove feedback motor from carburetor. Check for sticking shaft or dirt. Connect harness to motor and turn ignition on. Shaft should extend, then retract when ignition is turned off. If motion is uneven or shaft rotates, replace motor. Reinstall motor in carburetor.
- 10) Turn ignition off and disconnect vehicle harness from TAD solenoid. Connect an ohmmeter across TAD solenoid leads. If resistance is 50-100 ohms, go to next step. If not, replace TAD solenoid.
- 11) Disconnect MCU connector and TAD connector. Measure resistance between ground and pin 10 in MCU connector. If less than 1000 ohms, repair circuit. If more than 1000 ohms, reconnect MCU and go to next step.
- 12) Check connections and operation of TAD solenoid and valve. If wiring and hoses are properly connected, check for carburetor leaks, hose routing errors, and operation of bowl vent solenoid.

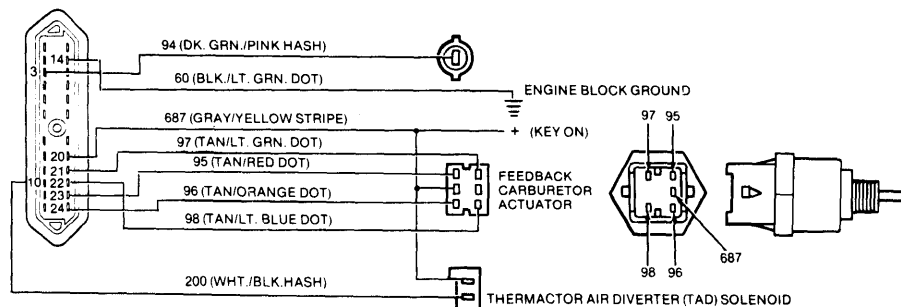

## FORD MOTOR CO. MCU ENGINE CONTROL SYSTEM (Cont.)

### V6 & V8 SUB-ROUTINES (Cont.)

23

#### FUEL ALWAYS RICH (CODE 42)

Vehicle must be at normal operating temperature. Disconnect jumper wire between ground and Self-Test trigger. Ensure power is present at choke cap, cold enrichment circuit works, and choke is off.

- 1) Disconnect ThermaCTOR air hose at pump, and vehicle harness at oxygen sensor. Connect a voltmeter between oxygen sensor and ground, then disconnect PCV hose from carburetor. Run engine at 1800 RPM for 60 seconds, then observe voltmeter. If voltage is greater than 0.5 volts, replace oxygen sensor. If voltage varies at less than 0.5 volts, reconnect PCV and oxygen sensor. Go to next step.
- 2) Disconnect vehicle harness from feedback motor on carburetor. Connect a known good motor (with shaft fully depressed) to harness, but leave original motor in carburetor. Turn ignition on. If shaft extends, then retracts slightly, go to next step. If motor does not extend, go to step 4).
- 3) Apply 10-12 in. Hg vacuum to vacuum switches. Start engine and place on high step of fast idle cam. Let engine run for 2 minutes, then force system rich by depressing CVR rod on top of carburetor. Observe test feedback motor. If shaft does not retract, disconnect motor and go to

next step. If shaft retracts until flush, turn ignition off, reconnect ThermaCTOR hose to pump, and go to step 6) .

- 4) Disconnect MCU connector from MCU, and disconnect feedback motor connector. Check continuity of all wires between feedback motor connector and MCU connector. If resistance in any circuit is more than 5 ohms, repair circuit. If resistance of all circuits is less than 5 ohms, proceed to next step.

5) Connect one lead of ohmmeter to engine ground, and test pins from feedback motor connector (except Gray/Yellow). If resistance of each circuit is more than 1000 ohms, replace MCU. If resistance of any circuit is less than 1000 ohms, repair circuit.

6) With ignition off, connect ohmmeter between feedback motor case and center pin (directly below blank space) in motor. If resistance is less than 190,000 ohms replace motor. If greater than 190,000 ohms (or infinity), go to next step.

7) Remove feedback motor from carburetor. Check for sticking shaft or dirt. Connect harness to motor and turn ignition on. Shaft should extend, then retract when ignition is turned off. If motion is uneven, or shaft rotates, replace motor. Reinstall good motor in carburetor and check vacuum lines, evaporative emissions system, and crankcase for fuel dilution.

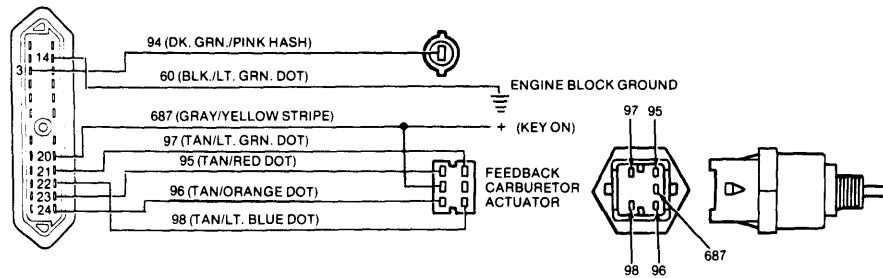

24

#### IDLE SPEED INCORRECT (CODE 12)

Adjust carburetor idle speed and retest. Check all connections to carburetor and throttle actuator or kicker. If not equipped with vacuum throttle kicker, start test at step 3).

- 1) If equipped with vacuum actuated throttle kicker, check for manifold vacuum at kicker at idle. If vacuum is present, stop engine and go to next step. If no vacuum is present, repair vacuum lines and retest.
- 2) Apply 10 in. Hg vacuum to throttle actuator. Arm should extend and hold position while vacuum is applied. If not, repair or replace actuator, then retest. If actuator does operate, go to next step.
- 3) Disconnect wiring from throttle kicker solenoid and measure resistance of solenoid. If resistance is between 45-90 ohms, go to next step. If not, replace solenoid and retest.

4) Check circuit resistance between throttle kicker relay connector and solenoid, then between solenoid and ground. If resistance is less than 5 ohms, proceed to next step. If resistance is greater than 5 ohms, repair circuit.

5) Disconnect MCU connector. Check circuits for continuity between MCU pin 12 and throttle kicker relay connector (Red/Lt Grn), and pin 20 and relay connector (Gray/Yel). If resistance is greater than 5 ohms, repair circuit. If resistance is less than 5 ohms, proceed to next step.

6) Connect ohmmeter between MCU connector pin 12 and ground. If resistance is less than 1000 ohms, repair circuit. If more than 1000 ohms, go to next step.

7) Leave MCU connector disconnected. Make sure A/C switch is off. Turn ignition on and connect voltmeter across solenoid terminals (with connector on solenoid). Ground pin 12 of MCU connector and observe voltmeter. If greater than 10 volts, replace MCU module. If less than 10 volts, replace relay.

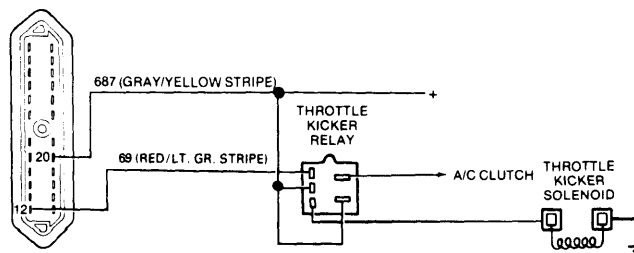

## FORD MOTOR CO. MCU ENGINE CONTROL SYSTEM (Cont.)

### V6 & V8 SUB-ROUTINES (Cont.)

25

#### THERMACTOR SYSTEM (CODE 44)

**NOTE** — On police vehicles, perform the following before proceeding to step 1): Start engine and operate until normal operating temperature is reached. Turn engine off. Restart engine at curb idle. Immediately initiate "Function Test". Observe DVOM for service codes. If service code 11 appears, proceed to "Non-Code Tests" in this section. If any other codes appear, proceed to appropriate "Sub-Routines" test.

- 1) Check for manifold vacuum at input to TAB-TAD solenoids. If vacuum is present, go to next step. If not, check hose condition and routing.
- 2) Remove vacuum hose from TAB valve and connect vacuum gauge to hose. Start engine and run at 2,000 RPM for 2 minutes. Stop engine, then immediately restart and allow to idle. Begin Self-Test and watch vacuum gauge. If pulses are above and below 5 in. Hg, proceed to next step. If gauge is always above 5 in. Hg, proceed to step 4). If always below 5 in. Hg, proceed to step 6).
- 3) Reconnect hose to TAB valve. Remove hose from TAD valve and connect vacuum gauge to hose. Start engine, run for 2 minutes above 2000 RPM, then stop engine. Restart immediately and observe vacuum gauge as Self-Test starts. If vacuum pulses above and below 5 in. Hg, check ThermaCTOR pump operation. If vacuum is always above 5 in. Hg, go to step 10). If below 5 in. Hg, go to step 12).
- 4) Disconnect MCU connector and TAB connector. Measure resistance between MCU connector pin 11 and ground. If less than 1000 ohms, repair short to ground. If greater than 1000 ohms, go to next step.
- 5) Check at TAB solenoid output to make sure vacuum is not present when solenoid is deactivated (engine idling, harness disconnected). If vacuum is present, replace TAB solenoid. If no vacuum, replace MCU module.
- 6) Check vacuum hose between TAB valve and TAB solenoid for damage. If damaged, repair or replace. If hose is okay, go to next step.
- 7) Measure TAB solenoid resistance. If not within 50-110 ohms, replace solenoid. If resistance is correct, go to step 8).

8) Check at TAB solenoid output to be sure vacuum is present when solenoid is activated (engine idling, 12 volts applied). If no vacuum, replace TAB solenoid. If vacuum is present, go to next step.

9) Disconnect MCU connector and TAB solenoid connector. Continuity should exist between MCU pin 11 and White/Red wire at connector, and between pin 20 and Gray/Yellow wire at connector. If resistance is more than 5 ohms, repair circuit. If less than 5 ohms, replace MCU module.

10) Disconnect MCU connector and TAD solenoid connector. Measure resistance between MCU pin 10 and ground. If resistance is less than 1000 ohms, repair short. If more than 1000 ohms, go to next step.

11) Check at TAD solenoid output to ensure vacuum is not present with engine idling and TAD solenoid connector disconnected. If vacuum is present, replace TAD solenoid. If no vacuum, replace MCU module.

12) Check vacuum hose between TAD valve and TAD solenoid for blocks or leaks. If problems are found, repair. If hose is okay, go to next step.

13) Remove TAD solenoid connector and measure resistance across TAD solenoid. If not between 50-110 ohms, replace solenoid. If resistance is between 50-110 ohms, proceed to next step.

14) Check at TAD solenoid output to ensure vacuum is present with engine idling and solenoid energized with 12 volts. If vacuum is present, go to next step. If not, replace solenoid.

15) Measure resistance of White/Black wire between MCU pin 10 and TAD connector, then resistance of Gray/Yellow wire between pin 20 and TAD connector. If resistance in either circuit is more than 5 ohms, repair circuit. If less than 5 ohms, replace MCU module.

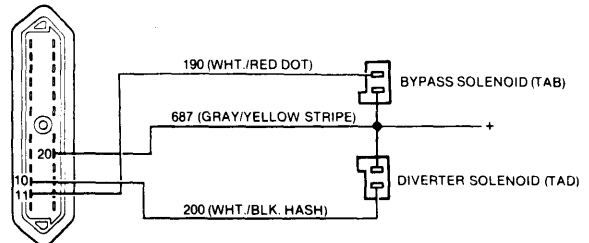

26

#### THERMACTOR AIR DIVERter (CODE 45)

- 1) Ensure that TAD vacuum line restrictor was uncapped and is free of obstruction. If plugged, clean out and retest. If okay, go to next step.
- 2) Cap vacuum restrictor and remove vacuum delay valve from TAD vacuum control line. Reconnect system and retest. If code 45 reappears, go to next step. If not, replace vacuum delay valve with new part and retest.
- 3) Remove vacuum hose from TAD valve and connect a vacuum gauge to hose. Start engine and run above 2000 RPM for 2 minutes, then stop engine. Restart engine and initiate Self-Test, then watch vacuum gauge. If vacuum pulses above and below 5 in. Hg, check ThermaCTOR pump. If vacuum is always above 5 in. Hg, go to step 8). If vacuum is always below 5 in. Hg, go to next step.
- 4) Check vacuum hoses between TAD valve and solenoid, then between solenoid and source. Repair if necessary. If hoses are okay, go to next step.
- 5) Remove TAD connector and measure TAD solenoid resistance. If between 50-110 ohms, go to next step. If not, replace solenoid.
- 6) Check at TAD solenoid output to ensure vacuum is present when solenoid is energized by 12 volts. If no vacuum, replace solenoid. If vacuum is present, go to next step.

7) Disconnect both TAD and MCU connectors. Measure resistance between MCU pin 20 and TAD Gray/Yellow wire, and between pin 10 and White/Black wire. If resistance is less than 5 ohms, replace MCU module. If greater than 5 ohms, repair circuits.

8) Check at TAD solenoid output that vacuum is not present when solenoid is deactivated (engine idling, solenoid disconnected). If vacuum is present, replace solenoid. If not present, go to next step.

9) Disconnect MCU and TAD connectors. Connect ohmmeter between MCU connector pin 10 and ground. If resistance is less than 1000 ohms, repair short to ground. If more than 1000 ohms, replace MCU module.

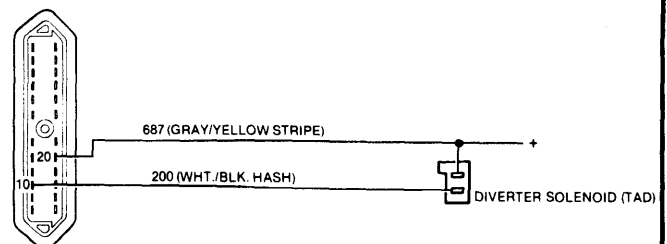

## FORD MOTOR CO. MCU ENGINE CONTROL SYSTEM (Cont.)

27

### THERMACTOR AIR BY-PASS (CODE 46)

**NOTE** — On police vehicles, perform the following before proceeding to step 1): Start engine and operate until normal operating temperature is reached. Turn engine off. Restart engine at curb idle. Immediately initiate "Function Test". Observe DVOM for service codes. If service code 11 appears, proceed to "Non-Code Tests" in this section. If any other codes appear, proceed to appropriate "Sub-Routines" test.

- 1) Remove vacuum hose from TAB valve and connect vacuum gauge to hose. Start engine and run above 2000 RPM for 2 minutes, then stop engine. Restart engine and initiate Self-Test. Watch vacuum gauge. If vacuum pulses above and below 5 in. Hg, check Thermoactor pump. If vacuum is always above 5 in. Hg, go to step 5). If always below 5 in. Hg, go to next step.
- 2) Check vacuum hoses between TAB valve, solenoid, and vacuum source. If hoses are leaking or blocked, repair. If hoses are okay, go to next step.
- 3) Check at TAB solenoid output to ensure vacuum is present with engine idling and 12 volts applied to solenoid. If no vacuum, replace solenoid. If vacuum is present, go to next step.
- 4) Disconnect TAB connector and MCU connector. Measure resistance between TAB connector wire (White/Red) and MCU connector pin 11. If less than 10 ohms, replace MCU. If more than 10 ohms, repair circuit.
- 5) Check TAB solenoid output to ensure vacuum is not present when solenoid is deactivated. If vacuum is present, replace solenoid. If vacuum is not present, go to next step.
- 6) Measure resistance between MCU connector pin 11 and ground. If resistance is less than 1000 ohms, repair short. If greater than 1000 ohms, replace MCU module.

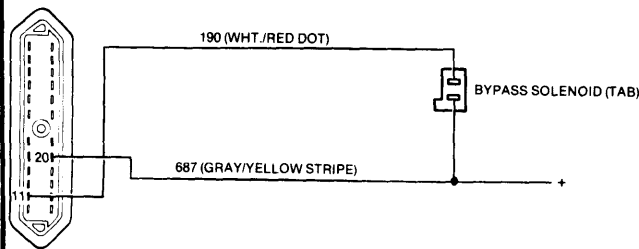

28

### KNOCK DETECTION SYSTEM (CODE 25)

Ensure that intake manifold was tapped with steel object within 2" from knock sensor. If not, retest, then remove jumper wire from Self-Test Triggerger.

- 1) With ignition off, disconnect harness from knock sensor. Using a 1 1/8" deep socket, loosen sensor and torque to 12-18 ft. lbs. (16-24 N·m). Do not overtighten. Proceed to next step.
- 2) Disconnect MCU connector. Connect ohmmeter between engine ground and pin 13 in MCU connector. If resistance is less than 1000 ohms, repair circuit. If more than 1000 ohms, go to next step.
- 3) Check continuity between pin 13 and knock sensor connector (Yel/Red). If less than 5 ohms, proceed to next step. If not, repair circuit.
- 4) Check continuity between pin 14 and knock sensor connector (Blk/Lt Grn). If less than 5 ohms, proceed to next step. If greater than 5 ohms, repair circuit.
- 5) Reconnect Self-Test Triggerger jumper on Self-Test connector. Connect a 12v test lamp to battery positive terminal, then disconnect knock sensor. Perform first step of MCU Running Test, then instead of tapping manifold with rod, tap test lamp to Yellow/Red contact in knock sensor connector for 5 seconds. Observe voltmeter. If code 25 appears, replace MCU module. If any other code appears, replace knock sensor.

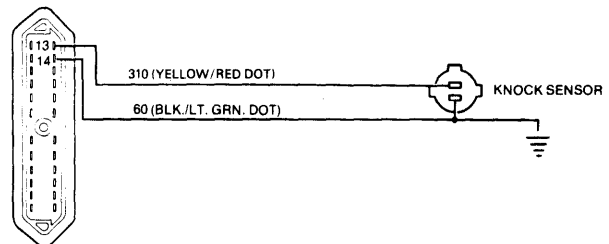

29

### NO SELF-TEST OUTPUT

Disconnect jumper wire from Self-Test Trigger in Self-Test connector.

- 1) Disconnect harness connector at MCU. Connect a voltmeter between pins 14 and 20 in MCU connector. With ignition on, 10.5 volts or more should be present. If so, go to step 3). If not, go to next step.
- 2) Connect voltmeter between pin 20 and ground. If voltage is now more than 10.5 volts, repair circuit from pin 14 to ground. If not, repair circuit from pin 20 to battery.
- 3) With ignition off, check continuity of circuit from MCU connector pin 14 to Self-Test connector to ground. If resistance is less than 1,000 ohms, proceed to next step. If resistance is greater than 1,000 ohms, repair circuits.
- 4) Check for continuity between MCU connector pin 19 and Self-Test trigger socket. If resistance is less than 5 ohms, proceed to next step. If resistance is greater than 5 ohms, repair circuit.
- 5) Check continuity between MCU connector pin 8 and "Tach Test" lead at coil "horseshoe" connector (remove connector from coil). If resistance is 5 ohms or less, proceed to next step. If resistance is greater than 5 ohms, repair circuit.

- 6) Disconnect canister purge connector. Check continuity between MCU connector pin 9 and Gray/Yellow stripe wire at canister purge connector. Also check between pin 20 and Gray/Yellow hash wire. If resistance of each circuit is less than 5 ohms, proceed to next step. If resistance is greater than 5 ohms, repair circuits.

- 7) Connect ohmmeter across canister purge solenoid. Resistance should be 50-100 ohms. If not, replace solenoid. If so, go to next step.
- 8) Connect ohmmeter between engine ground and Gray/Yellow Hash wire at canister purge solenoid. If resistance is greater than 1000 ohms, go to next step. If less, repair short circuit to ground.
- 9) Check to ensure canister purge solenoid passes vacuum when energized with 12 volts, and blocks vacuum when de-energized. Check housing for leaks. If solenoid is okay, replace MCU module. If not, replace solenoid and retest.

