

1981 CHRYSLER CORP. VACUUM DIAGRAMS

NOTE — Vacuum diagrams were not available from Chrysler Corp. for all 1982 models. Therefore, this section contains both 1981 and 1982 vacuum diagrams, but may not cover all applications.

The color code chart, at the right, has been supplied as a legend for the circled letters appearing in some of the vacuum diagrams.

Vacuum Diagrams Color Code Chart

These codes apply to wire colors on Chrysler Vacuum Diagrams.

- | | |
|-------------------|-------------------|
| BK — Black | P — Purple |
| B — Blue | R — Red |
| GY — Gray | T — Tan |
| G — Green | W — White |
| O — Orange | Y — Yellow |

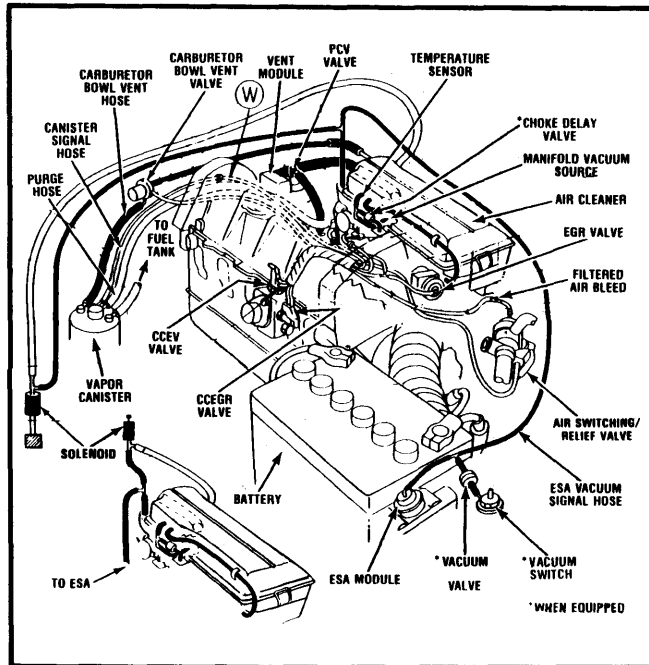

Fig. 1 1981 2.2L (135") 4-Cyl. (Horizon & Omni W/A/C)

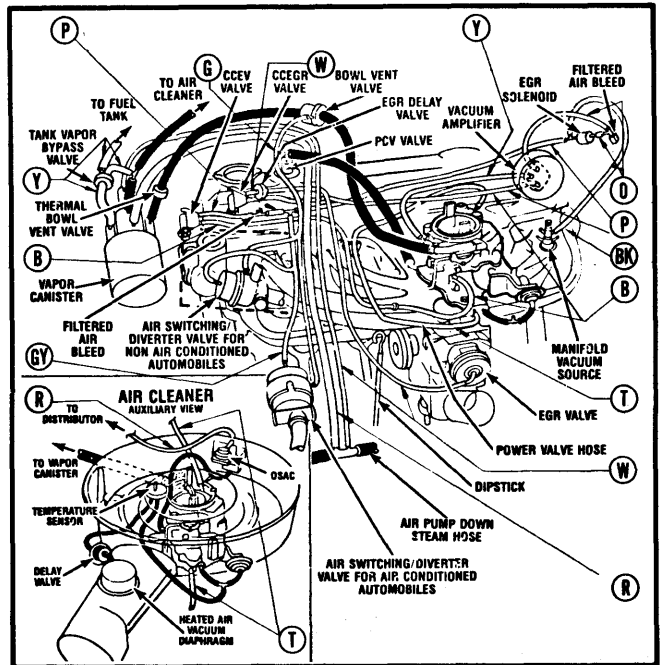

Fig. 2 1981 3.7L (225") 6-Cyl. Federal (Cordoba, Diplomat, Mirada, New Yorker)

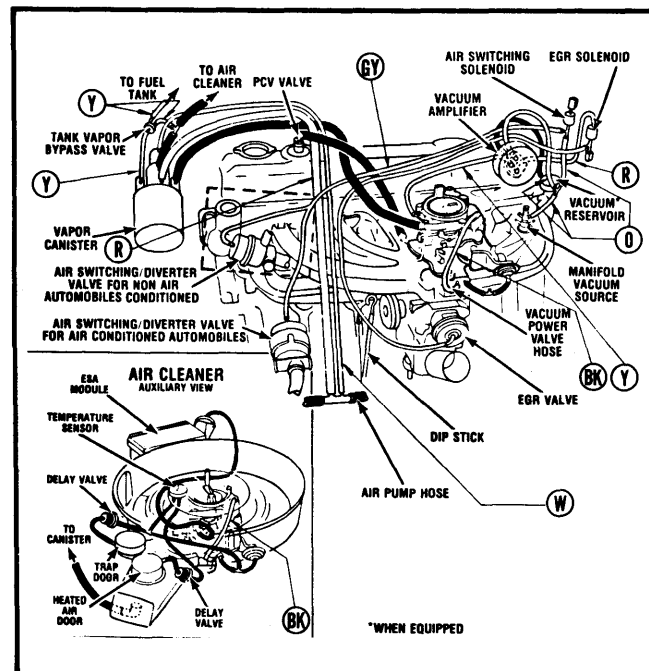

Fig. 3 1981 3.7L (225") 6-Cyl. Calif. (Cordoba, Diplomat, Mirada, New Yorker)

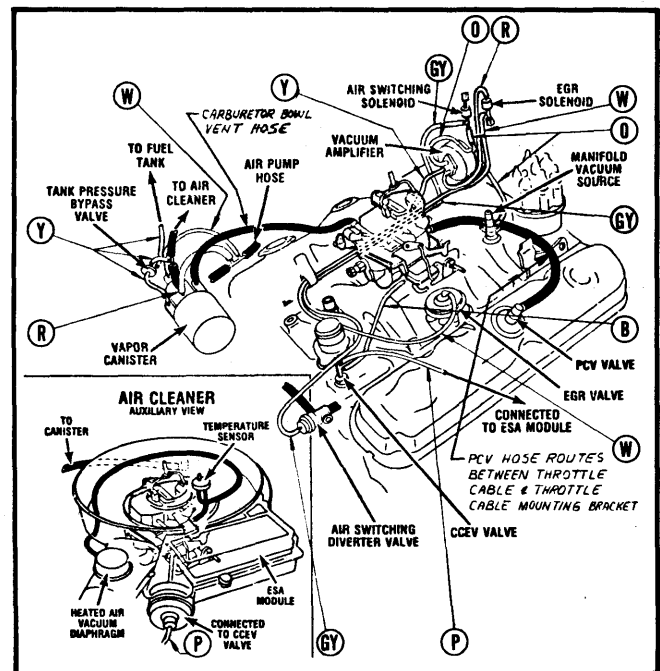

Fig. 4 1981 5.2L (318") V8 2-Bbl.; Federal (Cordoba, Diplomat, Mirada, New Yorker)

1982 Exhaust Emission Systems

1981 CHRYSLER CORP. VACUUM DIAGRAMS (Cont.)

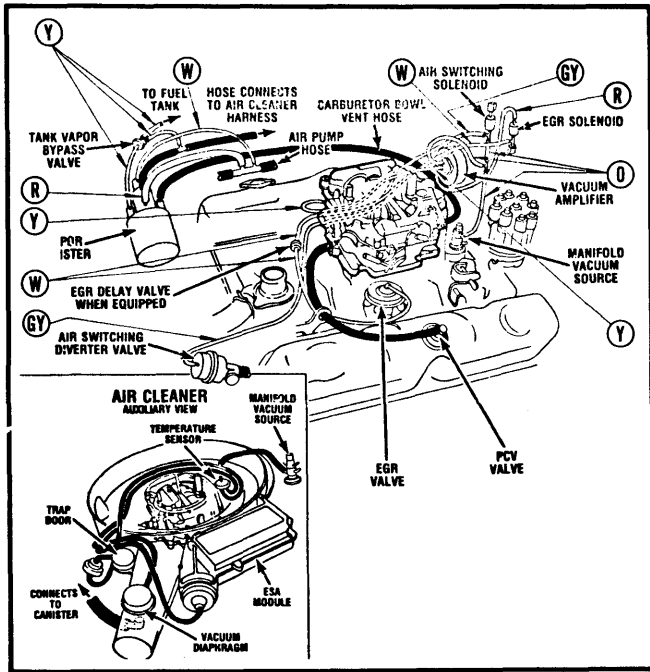

Fig. 5 1981 5.2L (318") V8 4-Bbl.; Federal & Calif. (Cordoba, Diplomat, Mirada, New Yorker)

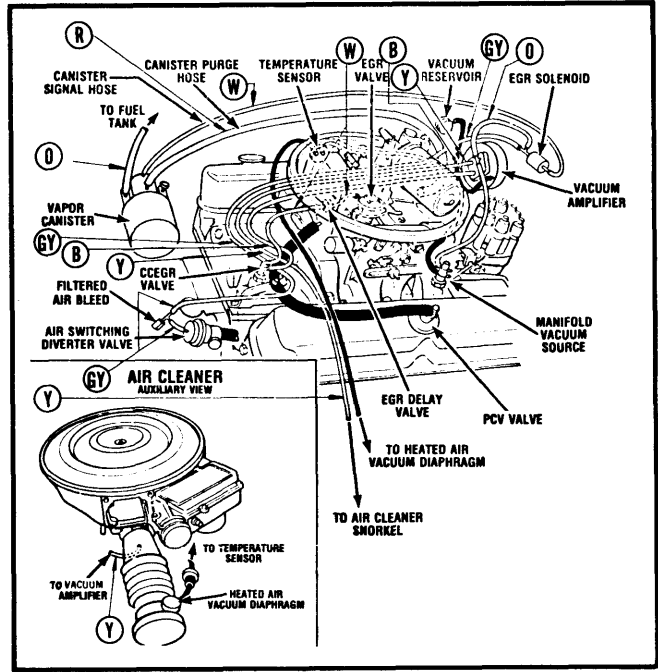

Fig. 6 1981 5.2L (318") V8 EFI; Federal & Calif. (Imperial)

1982 CHRYSLER CORP. VACUUM DIAGRAMS

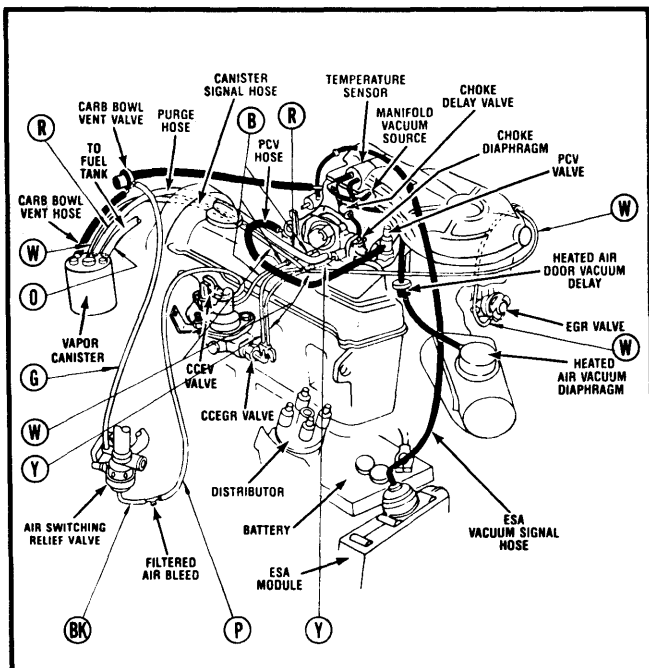

Fig. 1 1982 1.7L (105") 4-Cyl. (Horizon, Omni & Rampage)

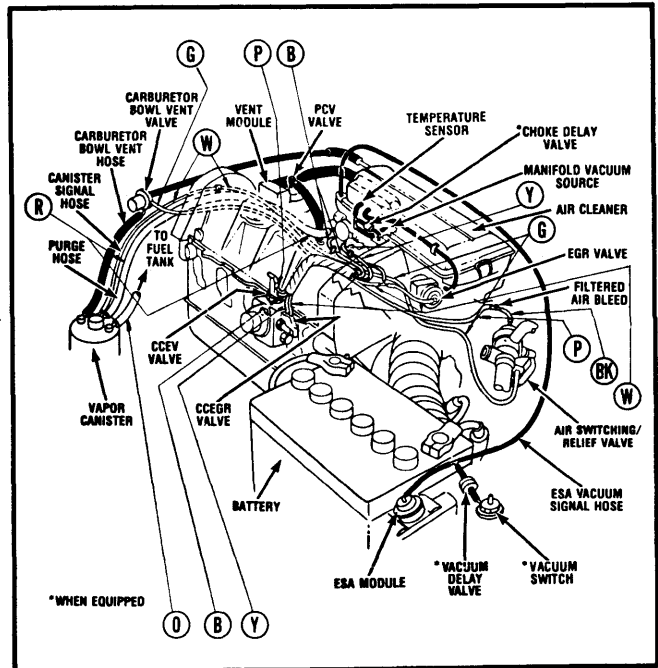

Fig. 2 1982 2.2L (135") 4-Cyl. (Aries, Horizon, LeBaron, Omni, Rampage, Reliant & 400)

1982 CHRYSLER CORP. VACUUM DIAGRAMS (Cont.)

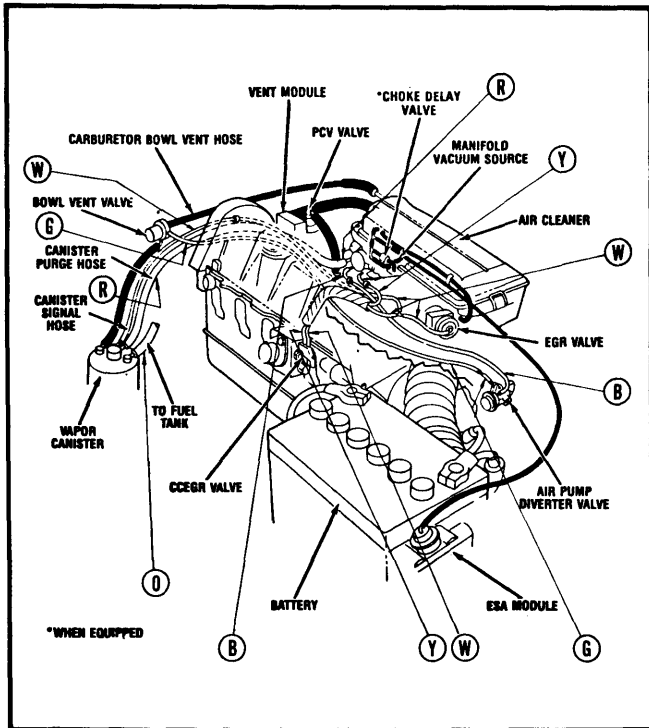

Fig. 3 1982 2.2L (135") 4-Cyl.; Federal (Omni & Rampage)

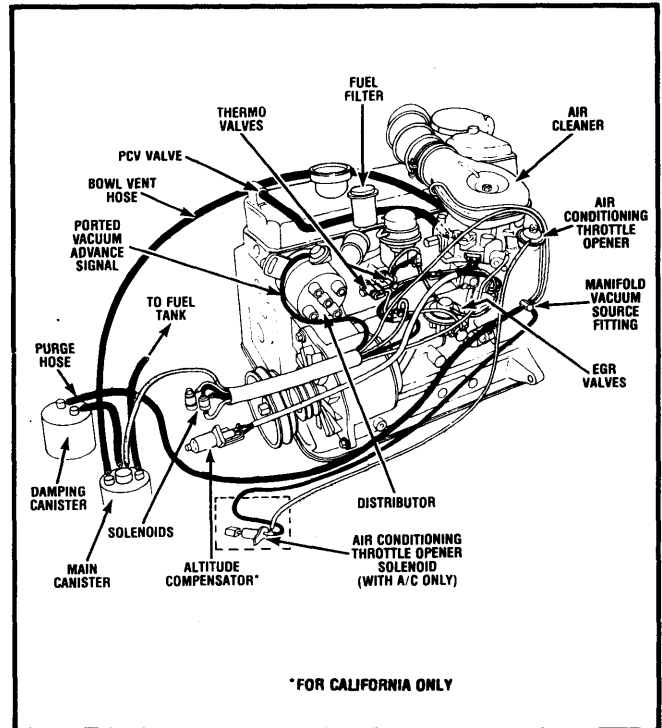

Fig. 4 1982 2.6L (156") 4-Cyl.; Calif.

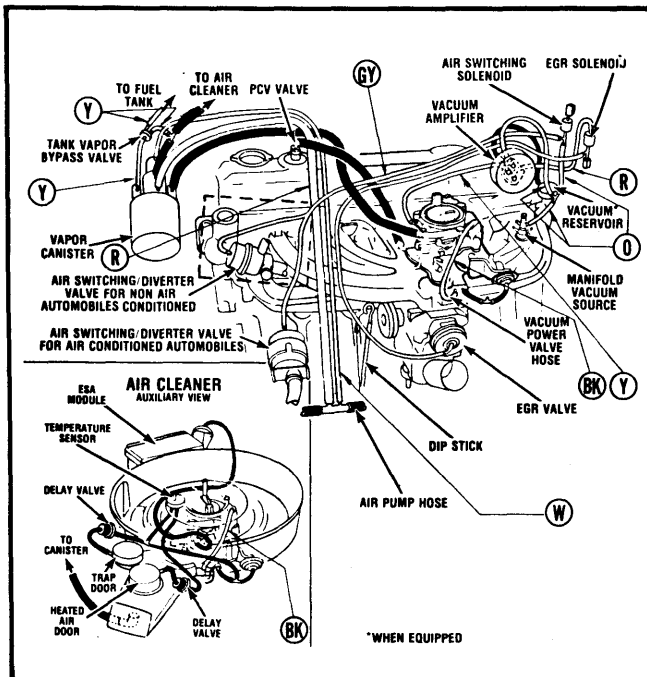

Fig. 5 1982 3.7L (225") 6-Cyl.; Calif. (Cordoba, Diplomat, Mirada, New Yorker)

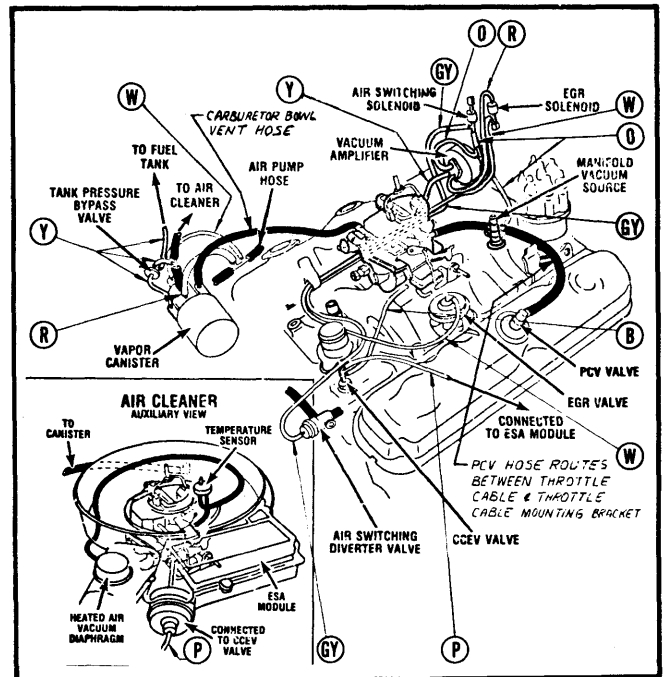

Fig. 6 1982 5.2L (318") V8 2-Bbl.; Federal (Cordoba, Diplomat, Mirada, New Yorker)

1982 Exhaust Emission Systems

1982 CHRYSLER CORP. VACUUM DIAGRAMS (Cont.)

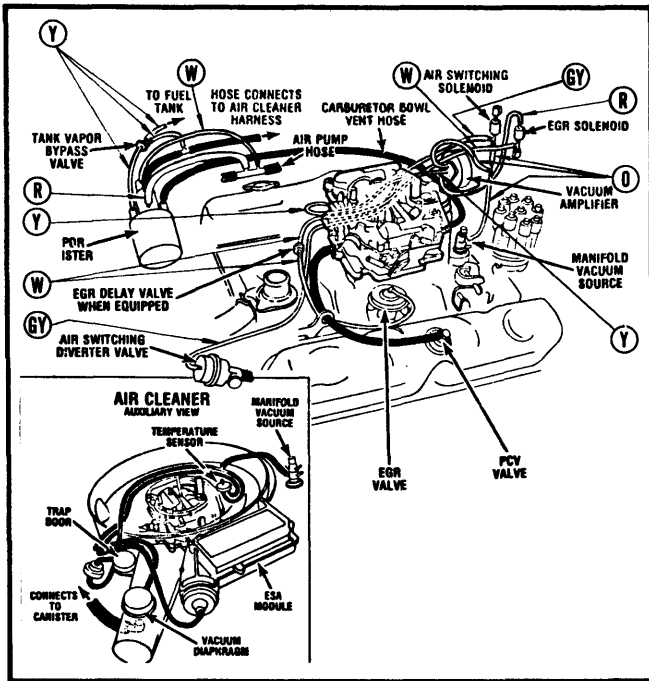

Fig. 7 1982 5.2L (318") V8 4-Bl.; Federal & Calif.(Cordoba, Diplomat, Mirada, New Yorker)

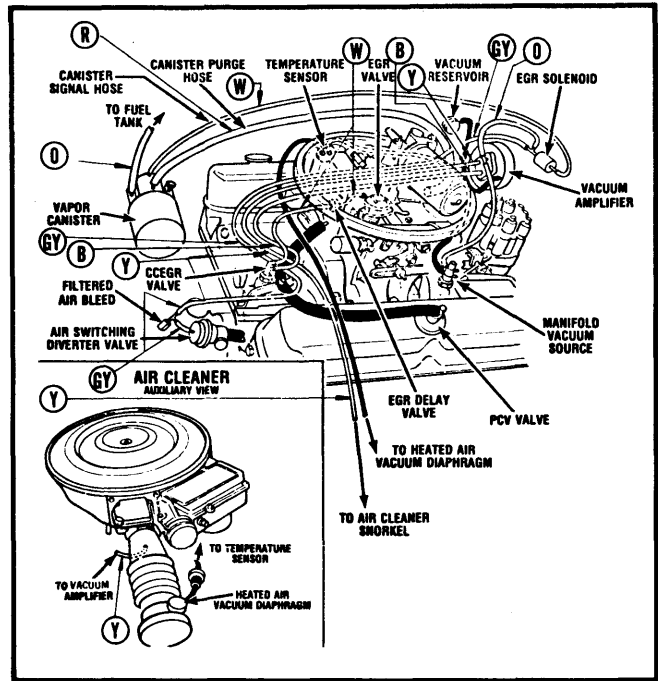

Fig. 8 1982 5.2L (318") V8 EFI; Federal & Calif. (Imperial)