

# 1981 Exhaust Emission Systems

## GENERAL MOTORS VACUUM DIAGRAMS

### MODEL IDENTIFICATION

Truck models, listed in tables, are identified using manufacturers letter and number designations. The letters identify the vehicle model series (i.e., "C" is conventional chassis, including Pickup, Blazer and Suburban). The number reference identifies the vehicles load capacity. Refer to following charts for actual letter and number designations.

VEHICLE SERIES IDENTIFICATION	
Vehicle Series	I.D. Letter
Conventional Chassis (2-WD) .....	C
Conventional Chassis (4-WD) .....	K
Conventional Van Chassis .....	G
Forward Control/Stepvan Chassis .....	P

VEHICLE LOAD CAPACITY		
Chevrolet Number	GMC Number	Ton Capacity
10 .....	1500 .....	1/2
20 .....	2500 .....	3/4
30 .....	3500 .....	1

GENERAL MOTORS VACUUM DIAGRAM REFERENCE CHART				
Vehicle Model, Series & Engine	Application	Transmission	Equipment Note	Figure Number
<b>LIGHT DUTY</b> 4.1L (250") 6-Cyl. C10/20	Fed.	Man.		1
	Fed.	Man.	Aux. Tk.	2
	Fed.	Auto.		①
	Fed.	Auto.	Aux. Tk.	3
	Fed. & Calif.	Man.	A.I.R.	4
	Fed. & Calif.	Man.	Aux. Tk. & A.I.R.	5
	Fed. & Calif.	Auto.	A.I.R.	6
	Fed. & Calif.	Auto.	Aux. Tk. & A.I.R.	7
	Fed.	Man.		8
	Fed.	Man.		9
	Calif.	Auto.		①
	Fed.	Man.	Aux. Tk.	10
	K10/20	Fed.	Auto.	
Fed.		Auto.	Aux. Tk.	3
Fed.		Man.		1
G10/20	Fed.	Man.		1
	Fed.	Auto.		11
<b>MEDIUM DUTY</b> 4.1L (250") 6-Cyl. C10 & K10	Calif.	Man.	A.I.R.	4
<b>HEAVY DUTY</b> 4.8L (292") 6-Cyl. C20/30 & K20/30	Fed. & Calif.	Man. & Auto.	A.I.R.	12
	Fed & Calif.	Man. & Auto.	A.I.R.	13
	Fed. & Calif.	Man. & Auto.	A.I.R.	12
<b>LIGHT DUTY</b> 5.0L (305") V8 C10/20 & K10/20	Fed.	Man.		14
	Fed.	Auto.		①
	Fed.	Man.		15
	Fed.	Auto.		16
	Fed.	Man.	A.I.R.	17
	Fed. & Calif.	Auto.	A.I.R.	18
	Calif.	Auto.	A.I.R.	19

## GENERAL MOTORS VACUUM DIAGRAMS (Cont.)

GENERAL MOTORS VACUUM DIAGRAM REFERENCE CHART					
Vehicle Model, Series & Engine	Application	Transmission	Equipment Note	Figure Number	
<b>LIGHT DUTY (Cont.)</b> G10/20	Fed.	Man.		14	
	Fed. & Calif.	Auto.	A.I.R.	18	
	Fed. & Calif.	Auto.	A.I.R.	19	
<b>MEDIUM DUTY</b> 5.0L (305") V8 C20	Calif.	Auto.	A.I.R.	19	
<b>LIGHT DUTY</b> 5.7L (350") V8 C10/20 & K10/20	Calif.	Auto.		⓪	
	Fed.	Man.		⓪	
	Fed.	Auto.	A.I.R.	20	
	Fed.	Auto.	A.I.R.	18	
	G10/20	Fed.	Man.	A.I.R.	21
		Fed.	Auto.	A.I.R.	22
		Fed. & Calif.	Auto.	A.I.R.	19
5.7L (350") Diesel V8	Fed. & Calif.	Auto.		⓪	
<b>MEDIUM DUTY</b> 5.7L (350") V8 C10/20	Calif.	Auto.	A.I.R.	18	
	G10/20	Calif.	Auto.	A.I.R.	19
<b>HEAVY DUTY</b> 5.7L (350") V8 C20/30 & K20/30	Fed.	Man. & Auto.	A.I.R.	23	
	Fed.	Man. & Auto.	A.I.R.	24	
	Fed. & Calif.	Man. & Auto.	A.I.R.	25	
	G30 & P20/30	Fed.	Man. & Auto.	A.I.R.	24
		Fed. & Calif.	Man. & Auto.	A.I.R.	25
		Fed.	Man.	A.I.R.	26
<b>HEAVY DUTY</b> 7.4L (454") V8 C20/30 & K20/30	Fed. & Calif.	Man. & Auto.	A.I.R.	27	
	Fed. & Calif.	Man. & Auto.	A.I.R.	28	

⓪ — Diagrams not available from General Motors.

### EMISSION CONTROL DEVICE ABBREVIATIONS

**AIR** — Air Injection Reactor  
**DVTR** — Diverter Valve  
**EFE** — Early Fuel Evaporation

**EGR** — Exhaust Gas Recirculation  
**PCV** — Positive Crankcase Ventilation

**TRC** — Throttle Return Control  
**TVS** — Thermal Vacuum Switch

## GENERAL MOTORS VACUUM DIAGRAMS (Cont.)

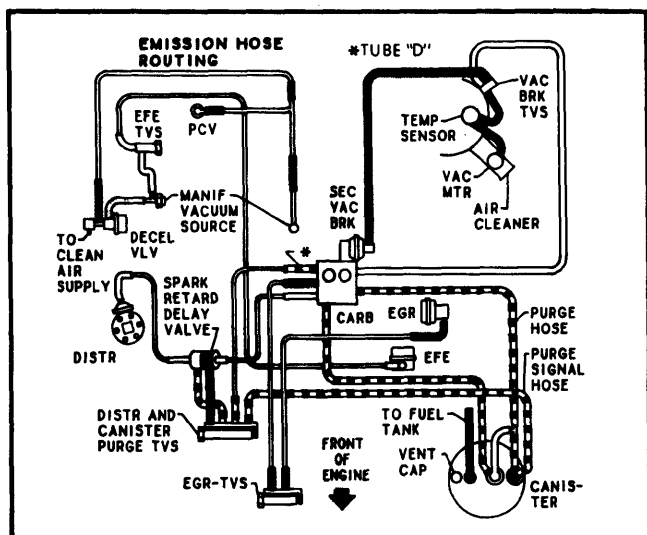

Fig. 1 4.1L 6-Cyl. Federal Manual Transmission

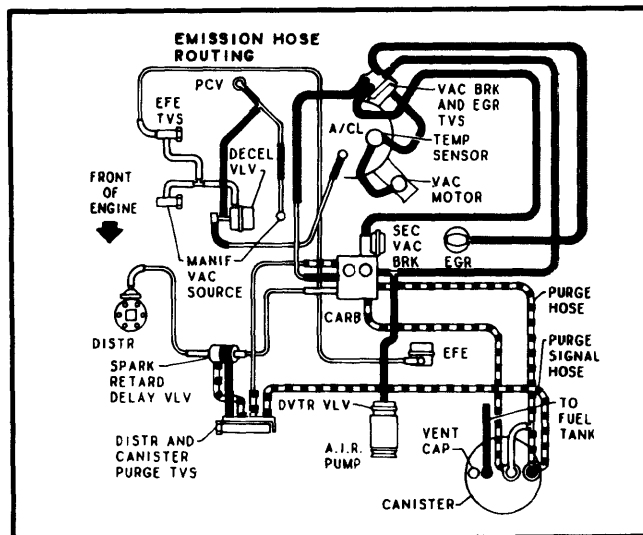

Fig. 4 4.1L 6-Cyl. Federal & California Manual Transmission

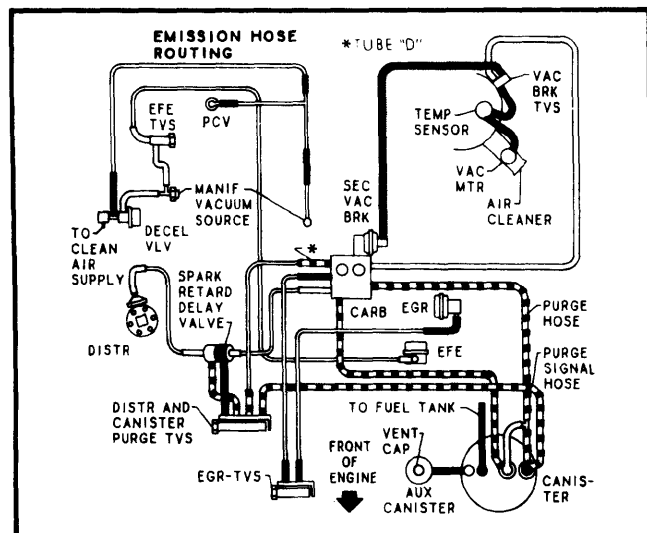

Fig. 2 4.1L 6-Cyl. Federal Manual Transmission & Auxiliary Tank

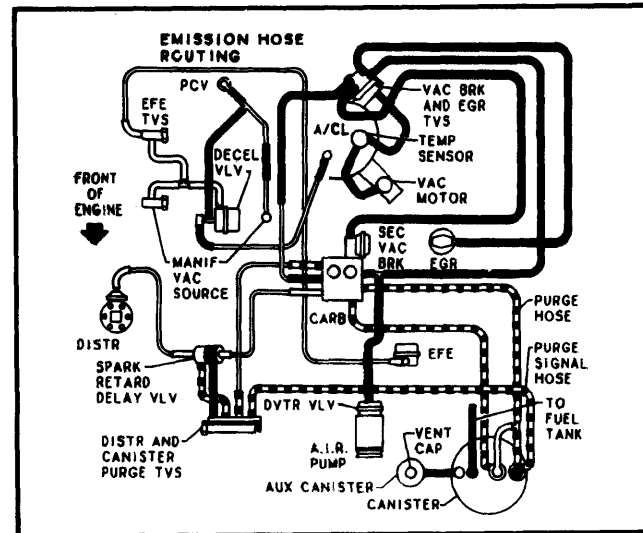

Fig. 5 4.1L 6-Cyl. Federal & California Manual Transmission & Auxiliary Tank

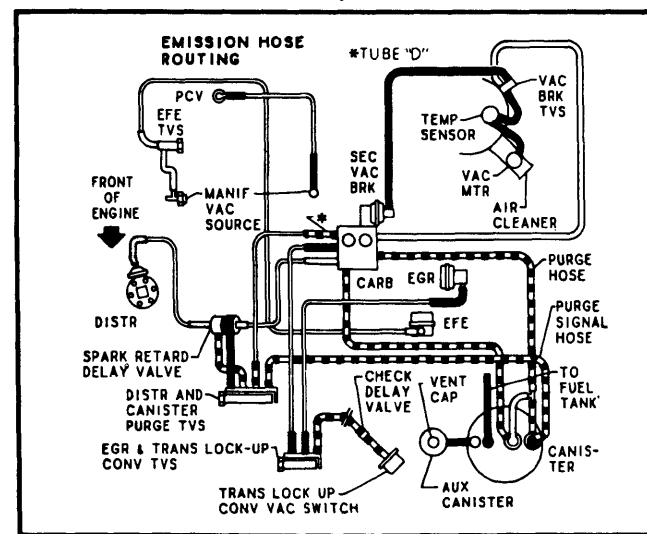

Fig. 3 4.1L 6-Cyl. Federal Automatic Transmission & Auxiliary Tank

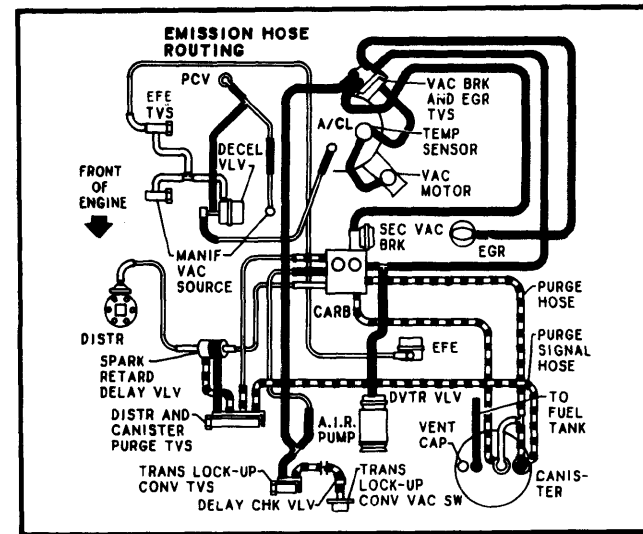
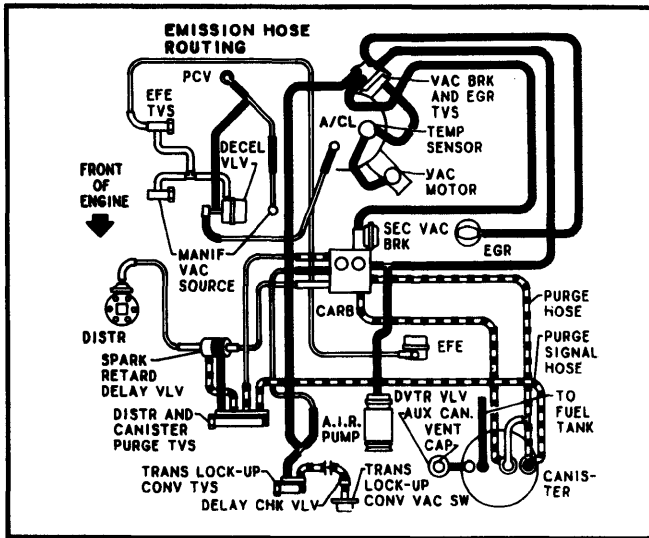
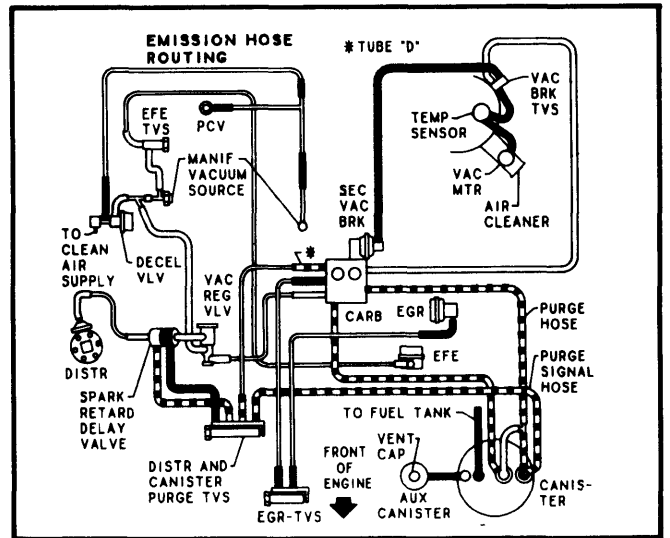

Fig. 6 4.1L 6-Cyl. Federal & California Automatic Transmission

## GENERAL MOTORS VACUUM DIAGRAMS (Cont.)



**Fig. 7** 4.1L 6-Cyl. Federal & California Automatic Transmission & Auxiliary Tank



**Fig. 10** 4.1L 6-Cyl. Federal Manual Transmission & Auxiliary Tank

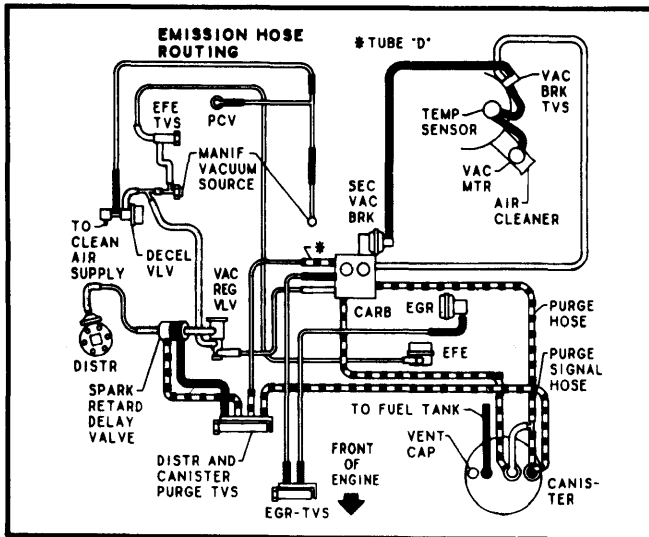

**Fig. 8** 4.1L 6-Cyl. Federal Manual Transmission

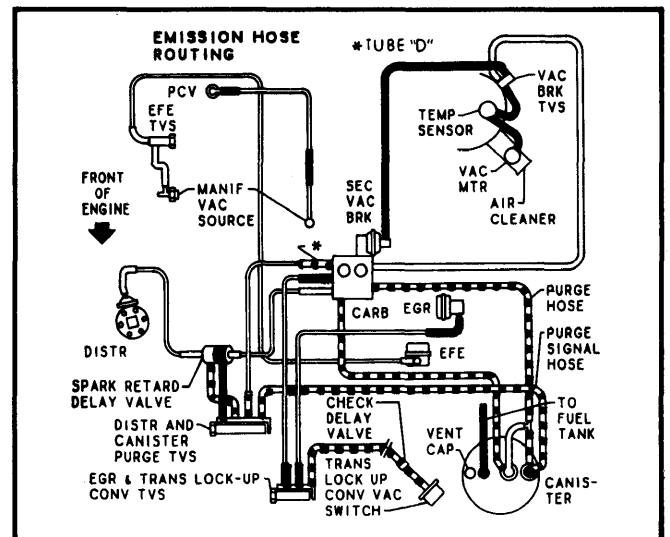

**Fig. 11** 4.1L 6-Cyl. Federal Automatic Transmission

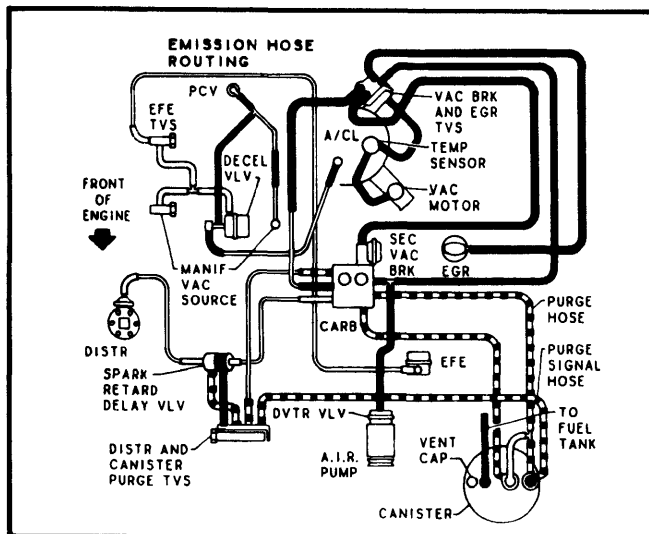

**Fig. 9** 4.1L 6-Cyl. Federal Manual Transmission

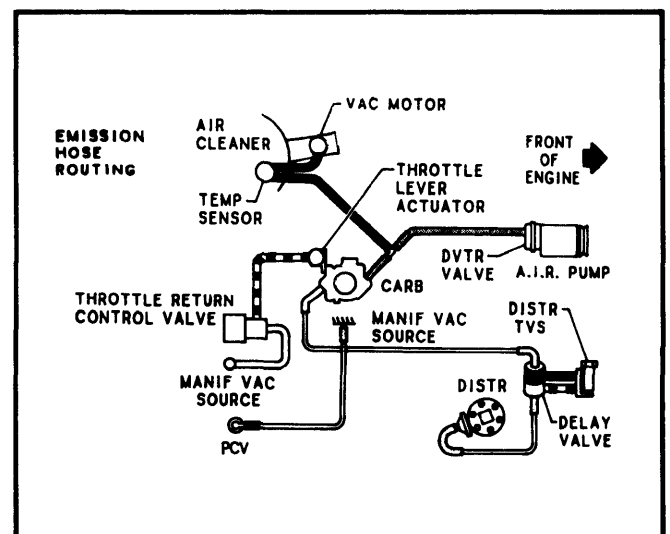

**Fig. 12** 4.8L 6-Cyl. Federal & California Manual & Automatic Transmission

# 1981 Exhaust Emission Systems

## GENERAL MOTORS VACUUM DIAGRAMS (Cont.)

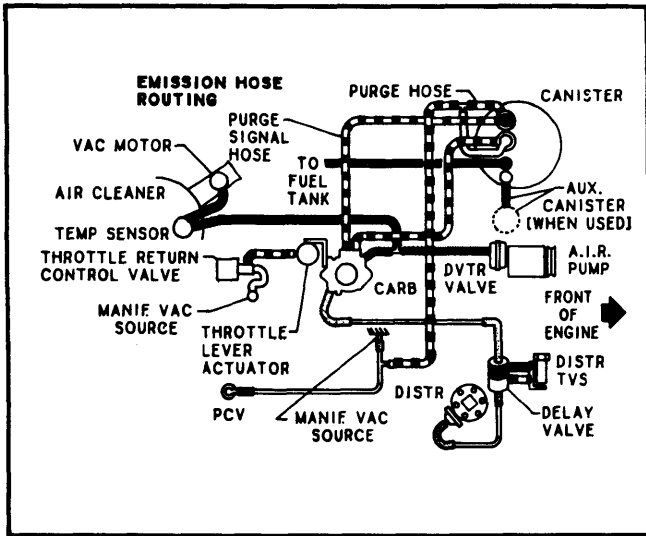

Fig. 13 4.8L 6-Cyl. Federal & California Manual & Automatic Transmission

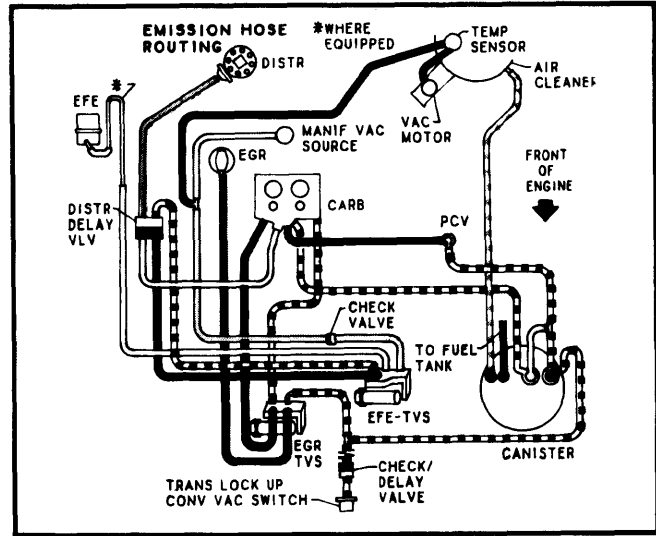

Fig. 16 5.0L V8 Federal Automatic Transmission

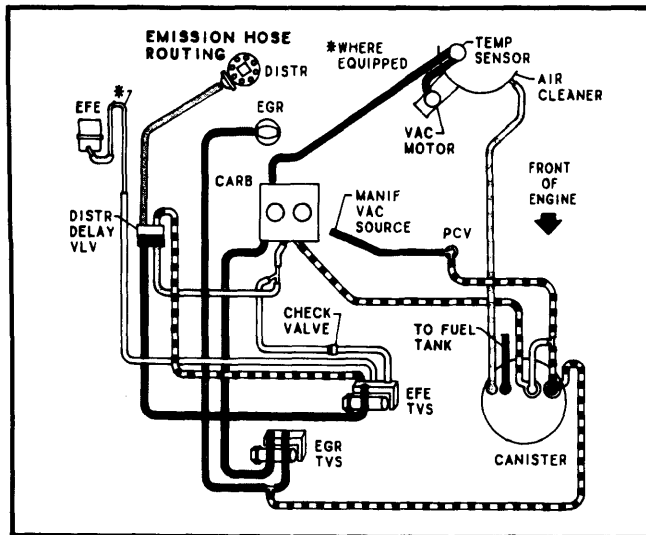

Fig. 14 5.0L V8 Federal Manual Transmission

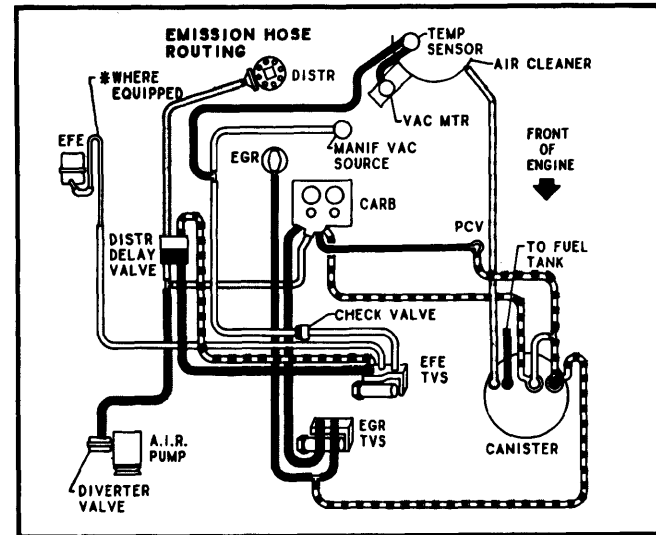

Fig. 17 5.0L V8 Federal Manual Transmission

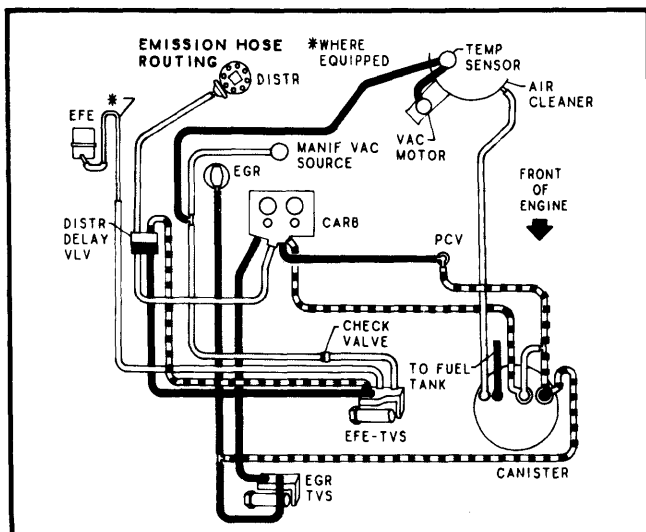

Fig. 15 5.0L V8 Federal Manual Transmission

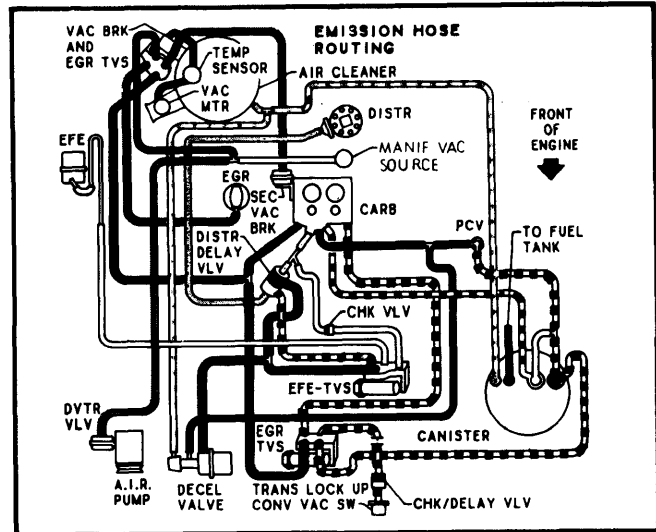
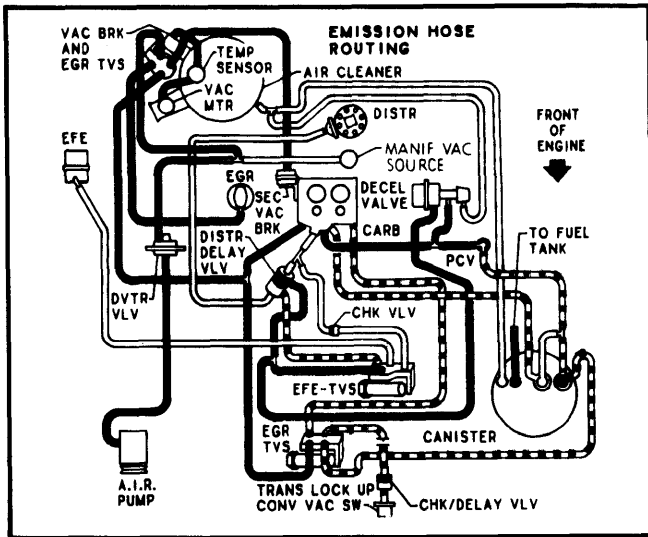
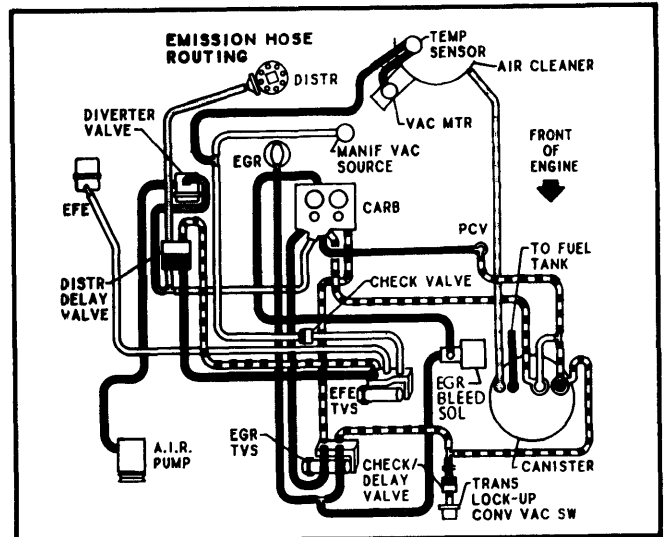

Fig. 18 5.0L V8 Federal & California Automatic Transmission

## GENERAL MOTORS VACUUM DIAGRAMS (Cont.)



**Fig. 19 5.0L V8 Federal & California Automatic Transmission**



**Fig. 22 5.7L V8 Federal Automatic Transmission**

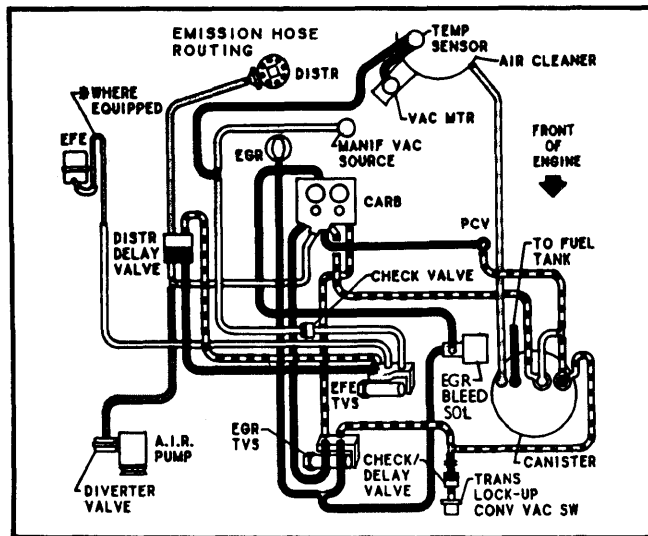

**Fig. 20 5.7L V8 Federal Automatic Transmission**

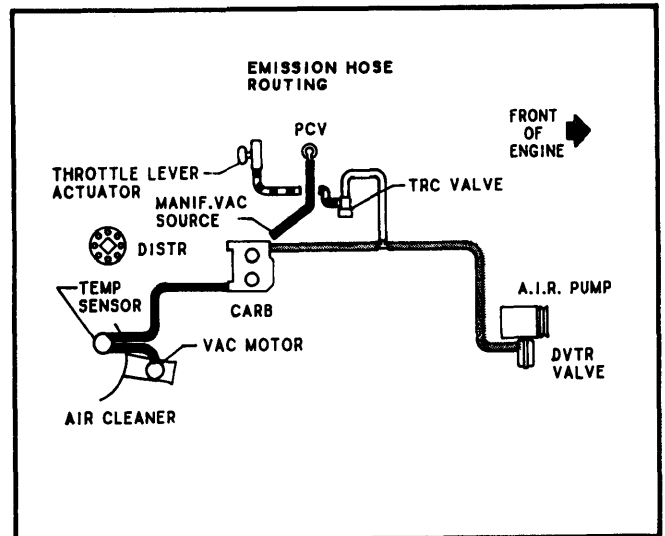

**Fig. 23 5.7L V8 Federal Manual & Automatic Transmission**

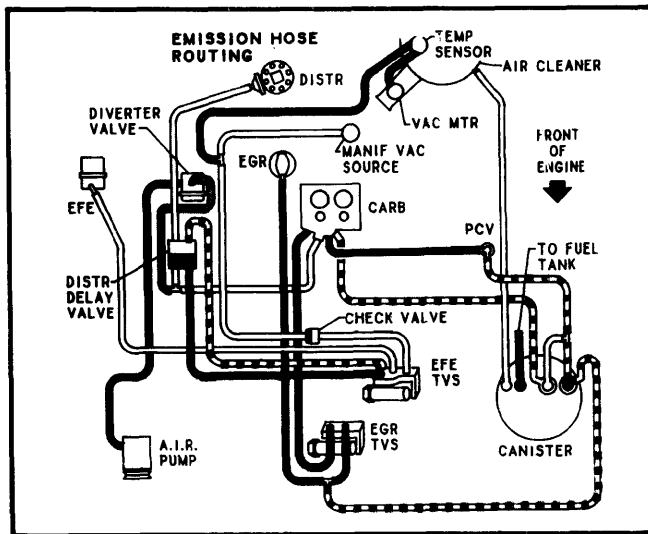

**Fig. 21 5.7L V8 Federal Manual Transmission**

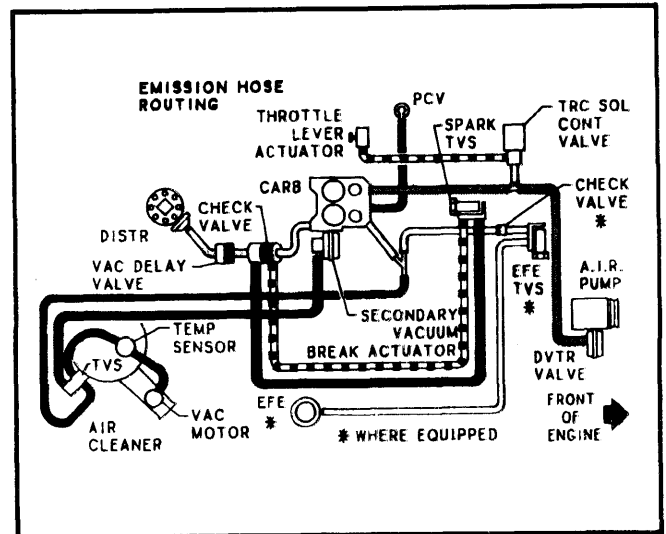

**Fig. 24 5.7L V8 Federal Manual & Automatic Transmission**

## GENERAL MOTORS VACUUM DIAGRAMS (Cont.)

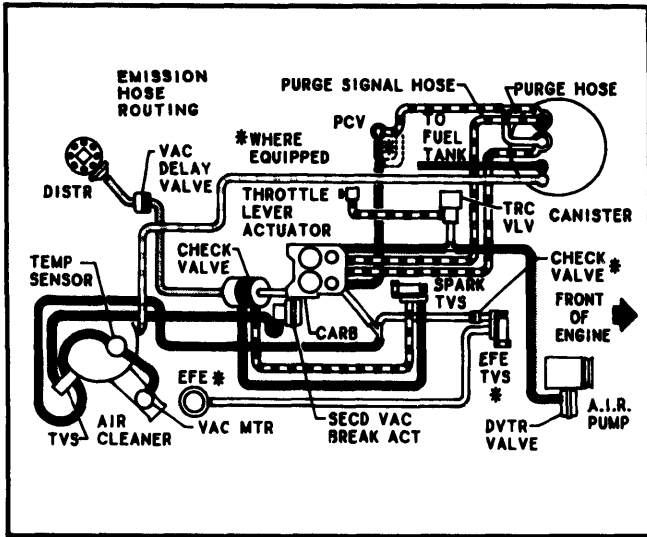

Fig. 25 5.7L V8 Federal & California Manual & Automatic Transmission

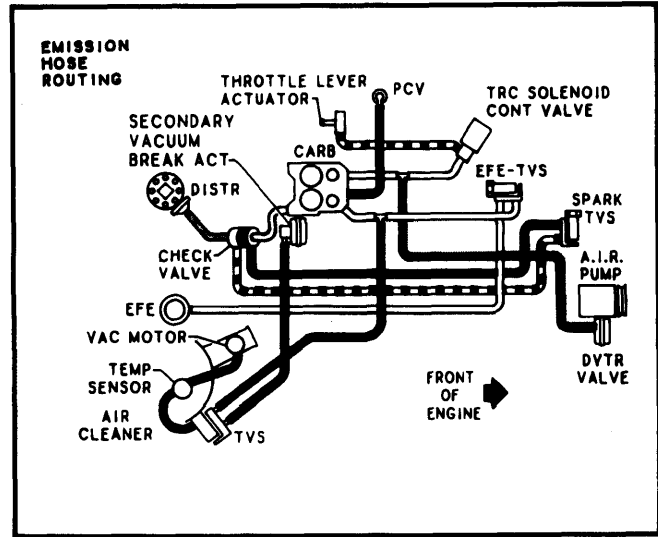

Fig. 27 7.4L V8 Federal & California Manual & Automatic Transmission

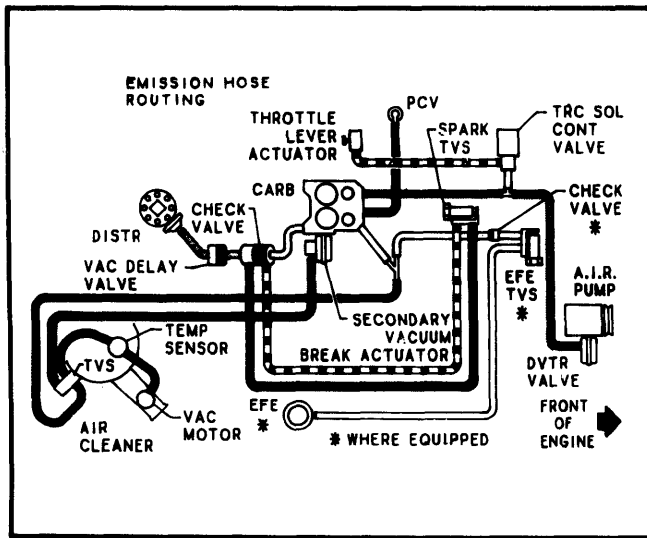

Fig. 26 5.7L V8 Federal Manual Transmission

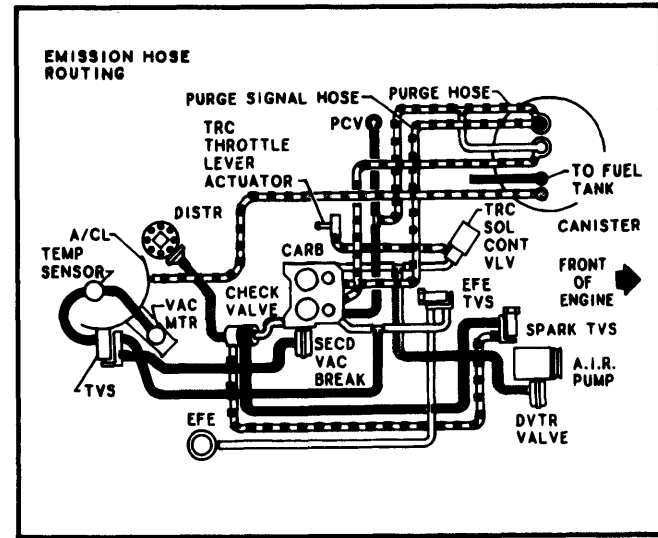

Fig. 28 7.4L V8 Federal & California Manual & Automatic Transmission