

# 1980 Exhaust Emission Systems

## GENERAL MOTORS VACUUM DIAGRAMS

### MODEL IDENTIFICATION

Reference will be made to body style codes for GM cars in the vacuum diagrams index. Refer to the table below for identification of these body style codes.

Body Code	GM Division	Model Name
A	Buick	Century, Regal
A	Chevrolet	Malibu, El Camino, Monte Carlo
A	Oldsmobile	Cutlass
A	Pontiac	LeMans, Grand Am, Grand LeMans
B	Buick	LeSabre, Electra
B	Chevrolet	Impala, Caprice
B	Oldsmobile	88, Custom Cruiser
B	Pontiac	Catalina, Bonneville
C	Buick	Electra
C	Cadillac	Fleetwood, DeVille
C	Oldsmobile	Ninety-Eight
D	Cadillac	Fleetwood Limousine

Body Code	GM Division	Model Name
E	Buick	Riviera
E	Cadillac	Eldorado
E	Oldsmobile	Toronado
F	Chevrolet	Camaro
F	Pontiac	Firebird
G	Pontiac	Grand Prix
H	Buick	Skyhawk
H	Chevrolet	Monza
H	Oldsmobile	Starfire
H	Pontiac	Sunbird
T	Chevrolet	Chevette
X	Buick	Skylark
X	Chevrolet	Citation
X	Oldsmobile	Omega
X	Pontiac	Phoenix
Y	Chevrolet	Corvette

### GENERAL MOTORS VACUUM DIAGRAM REFERENCE CHART

Engine & Make	Body Style	Application	Trans.	A/C	No A/C	Fuel System	Fig. No.
98" 4 Cyl. (VIN 9) Chev.	Chevette	Federal	Both	X	X	2-Bbl.	1
98" 4 Cyl. (VIN 0) Chev.	Chevette	Federal	Both	X	X	2-Bbl.	2
98" 4 Cyl. (VIN 9) Chev.	Chevette	Calif.	Both	X	X	2-Bbl.	3
98" 4 Cyl. (VIN 9) Chev.	Chevette	Calif.	Both	X	X	2-Bbl.	4
151" 4 Cyl. (VIN V) Chev., Olds., Pont.	H	Federal	Auto.		X	2-Bbl.	5
151" 4 Cyl. (VIN V) Chev., Olds., Pont.	H	Federal	Auto.	X		2-Bbl.	6
151" 4 Cyl. (VIN V) Chev., Olds., Pont.	H	Calif.	Man.	X	X	2-Bbl.	7
151" 4 Cyl. (VIN V) Chev., Olds., Pont.	H	Calif.	Auto.	X	X	2-Bbl.	8
151" 4 Cyl. (VIN 5) Buick, Chev., Olds., Pont.	X	Federal	Man.	X	X	2-Bbl.	9
151" 4 Cyl. (VIN 5) Buick, Chev., Olds., Pont.	X	Federal	Man.	X	X	2-Bbl.	10
151" 4 Cyl. (VIN 5) Buick, Chev., Olds., Pont.	X	Federal	Auto.	X	X	2-Bbl.	11
151" 4 Cyl. (VIN 5) Buick, Chev., Olds., Pont.	X	Federal	Auto.	X	X	2-Bbl.	12
151" 4 Cyl. (VIN 5) Buick, Chev., Olds., Pont.	X	Calif.	Man.		X	2-Bbl.	13
151" 4 Cyl. (VIN 5) Buick, Chev., Olds., Pont.	X	Calif.	Man.	X		2-Bbl.	14
151" 4 Cyl. (VIN 5) Buick, Chev., Olds., Pont.	X	Calif.	Auto.		X	2-Bbl.	15
151" 4 Cyl. (VIN 5) Buick, Chev., Olds., Pont.	X	Calif.	Auto.	X		2-Bbl.	16
173" V6 Buick, Chev., Olds., Pont.	X	Federal	Auto.	X		2-Bbl.	17
173" V6 Buick, Chev., Olds., Pont.	X	Federal	Auto.	X	X	2-Bbl.	18
173" V6 Buick, Chev., Olds., Pont.	X	Calif.	Auto.	X	X	2-Bbl.	19
229" V6 Chev., Pont.	A	Federal	Man.	X	X	2-Bbl.	20
229" V6 Chev.	B	Federal	Auto.		X	2-Bbl.	21
229" V6 Chev.	F	Federal	Auto.	X	X	2-Bbl.	22

## GENERAL MOTORS VACUUM DIAGRAMS (Cont.)

GENERAL MOTORS VACUUM DIAGRAM REFERENCE CHART							
Engine & Make	Body Style	Application	Trans.	A/C	No A/C	Fuel System	Fig. No.
231" V6 Buick, Chev., Olds., Pont.	A,F,G,H	Federal	Man.	X	X	2-Bbl.	23
231" V6 Buick, Olds., Pont.	A,G	Federal	Auto.	X	X	2-Bbl.	24
231" V6 Buick, Olds., Pont.	A,G	Federal	Auto.	X	X	2-Bbl.	25
231" V6 Buick, Chev., Olds., Pont.	B,H	Federal	Auto.	X	X	2-Bbl.	26
231" V6 Buick, Chev., Olds., Pont.	A,B,G	Federal	Auto.	X	X	2-Bbl.	27
231" V6 Buick, Chev., Olds., Pont.	H	Calif.	Man.	X	X	2-Bbl.	28
231" V6 Buick, Chev., Olds., Pont.	F,H	Calif.	Auto.	X	X	2-Bbl.	29
231" V6 Buick, Chev., Olds., Pont.	A,F,H	Calif.	Auto.	X	X	2-Bbl.	30
231" V6 Buick	B	Calif.	Auto.	X	X	2-Bbl.	31
231" V6 Buick	E	Federal	Auto.	X		Turbo	32
231" V6 Buick, Chev.	A	Federal	Auto.	X	X	Turbo	33
231" V6 Buick, Chev.	A	Federal	Auto.	X	X	Turbo	34
231" V6 Buick	E	Calif.	Auto.	X		Turbo	35
231" V6 Buick, Chev.	A	Calif.	Auto.	X	X	Turbo	36
252" V6 Buick, Cad.	B,C	Federal	Auto.	X		4-Bbl.	37
260" V8 Olds.	A	Federal	Auto.	X	X	2-Bbl.	38
260" V8 Olds.	B	Federal	Auto.	X	X	2-Bbl.	39
265" V8 Buick, Pont.	A,B,F,G	Federal	Auto.	X	X	2-Bbl.	40
267" V8 Chev.	F	Federal	Auto.	X	X	2-Bbl.	41
267" V8 Chev.	B	Federal	Auto.	X	X	2-Bbl.	42
301" V8 Pont.	A,B,F,G	Federal	Auto.	X	X	4-Bbl.	43
301" V8 Pont.	A,B,G	Federal	Auto.	X	X	4-Bbl.	44
301" V8 Pont.	F	Federal	Auto.	X	X	Turbo	45
305" V8 Chev., Olds., Pont.	A,B	Federal	Auto.	X	X	4-Bbl.	46
305" V8 Chev.	F	Federal	Man.	X	X	4-Bbl.	47
305" V8 Chev.	A,F	Federal	Man.	X		4-Bbl.	48
305" V8 Chev.	Corvette	Calif.	Auto.	X	X	4-Bbl.	49
305" V8 Buick, Chev., Olds., Pont.	A,B,F	Calif.	Auto.	X	X	4-Bbl.	50
305" V8 Chev.	F	Federal	Auto.	X		4-Bbl.	52
307" V8 Buick	E	Federal	Auto.	X		4-Bbl.	51
350" V8 (VIN L) Chev.	B,F	Federal	Auto.	X		4-Bbl.	52
350" V8 (VIN L) Chev.	F	Federal	Man.	X	X	4-Bbl.	48
350" V8 (VIN 6, 8) Chev.	Corvette	Federal	Man.	X	X	4-Bbl.	53
350" V8 (VIN 6, 8) Chev.	Corvette	Federal	Auto.	X	X	4-Bbl.	54
350" V8 (VIN R) Olds.	A,B,C	Federal	Auto.	X	X	4-Bbl.	55
350" V8 (VIN R) Buick	E	Federal	Auto.	X		4-Bbl.	56
350" V8 (VIN R) Buick, Olds., Pont.	B,C	Calif.	Auto.	X	X	4-Bbl.	57
350" V8 (VIN R) Buick	E	Calif.	Auto.	X		4-Bbl.	58
350" V8 (VIN X) Buick, Pont.	B,C	Federal	Auto.	X	X	4-Bbl.	59
350" V8 (VIN X) Buick, Pont.	B	Federal	Auto.	X	X	4-Bbl.	60
350" V8 (VIN B) Cad.	E, K	Calif.	Auto.	X		EFI	61
350" V8 (Diesel) All Divisions	A,B,C,E,K	All	Auto.	X	X	FI	62
368" V8 Cad.	E, K	Federal	Auto.	X		DEFI	63
368" V8 Cad.	C,D,Z	Federal	Auto.	X		4-Bbl.	64
368" V8 Cad.	C,D,Z	Calif.	Auto.	X		4-Bbl.	65

# 1980 Exhaust Emission Systems

## GENERAL MOTORS VACUUM DIAGRAMS

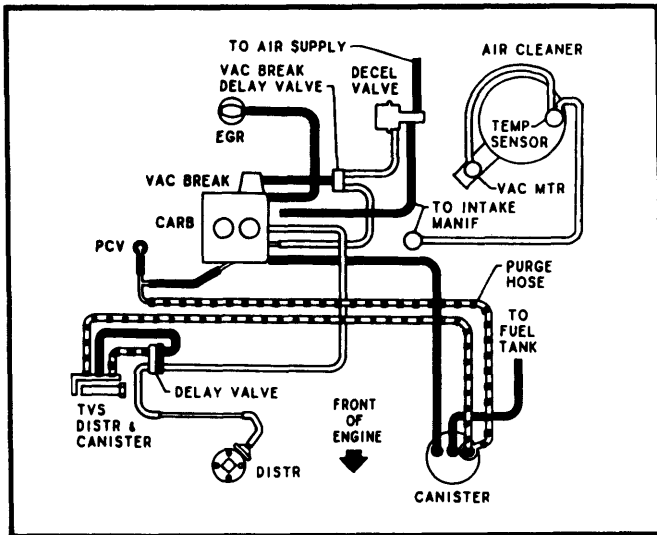


Fig. 1 98" 4 Cyl. 2-Bbl. Federal

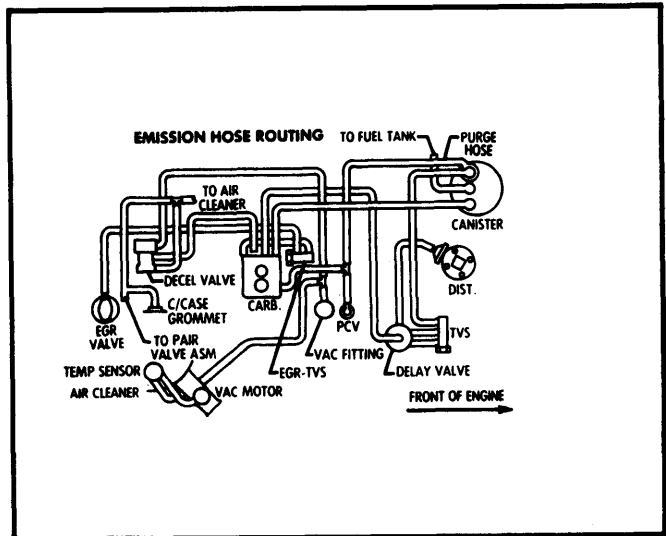


Fig. 4 98" 4 Cyl. 2-Bbl. Calif.

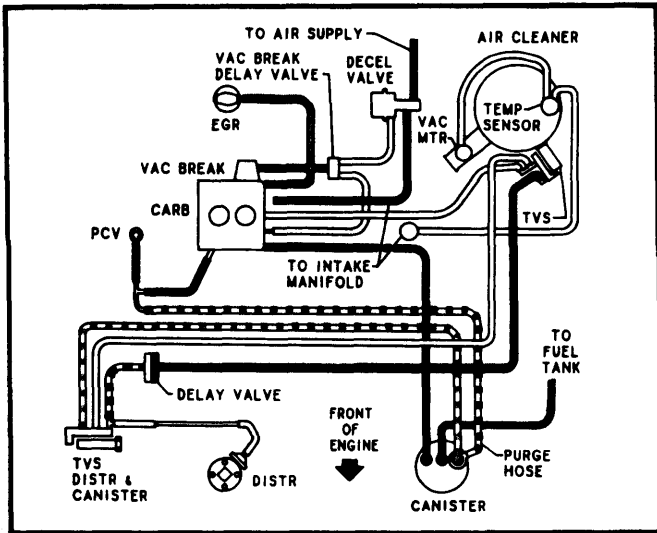


Fig. 2 98" 4 Cyl. 2-Bbl. Federal

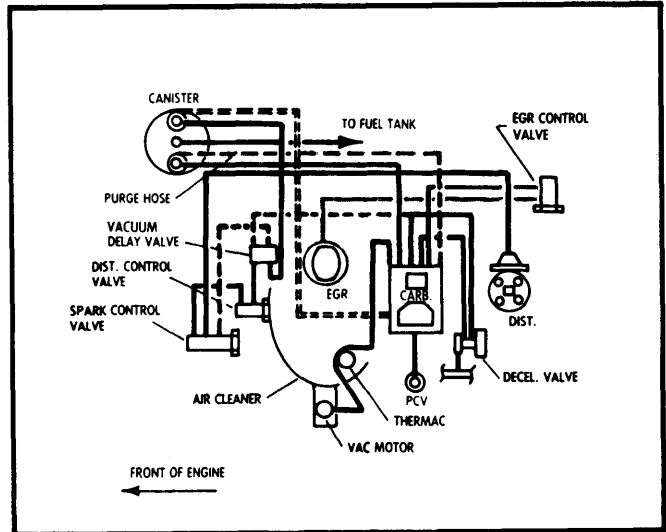


Fig. 5 151" 4 Cyl. 2-Bbl. VIN V Federal

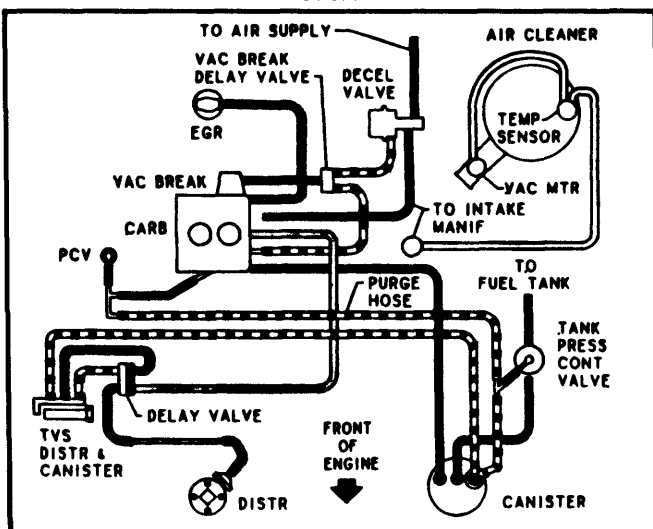


Fig. 3 98" 4 Cyl. 2-Bbl. Calif.

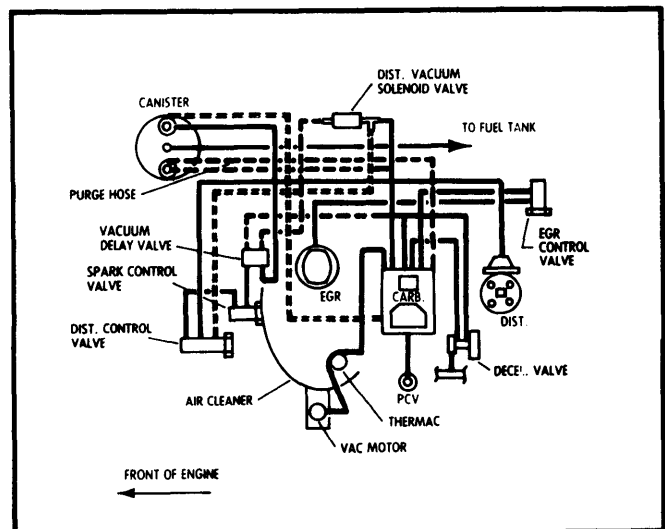
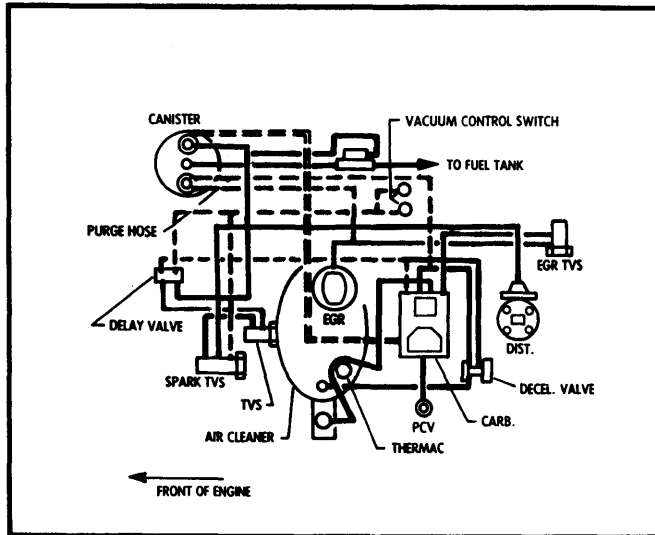
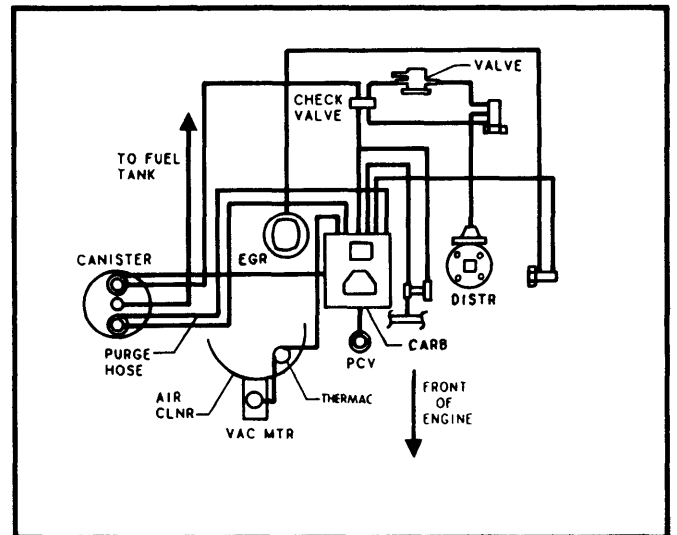


Fig. 6 151" 4 Cyl. 2-Bbl. VIN V Federal

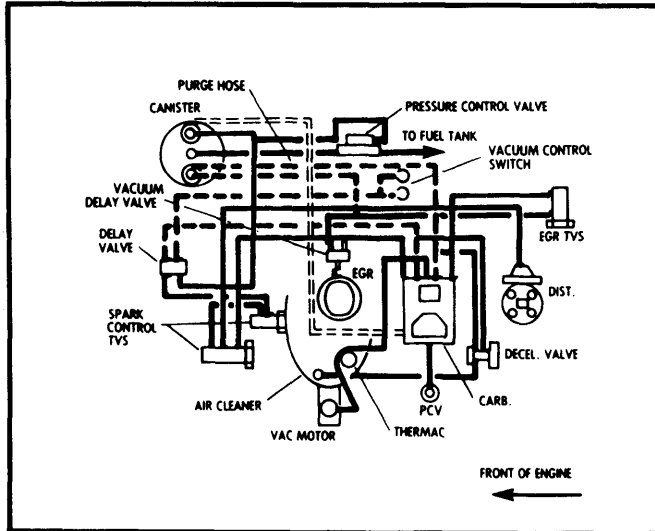
## GENERAL MOTORS VACUUM DIAGRAMS (Cont.)



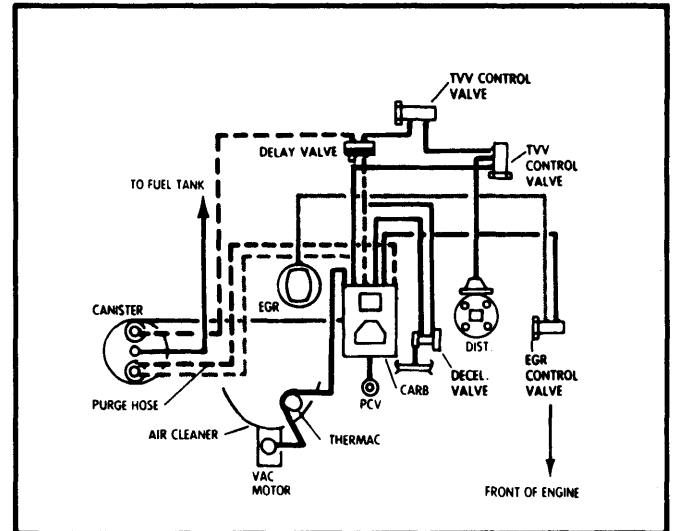
**Fig. 7 151" 4 Cyl. 2-Bbl.  
VIN V Calif. Man. Trans.**



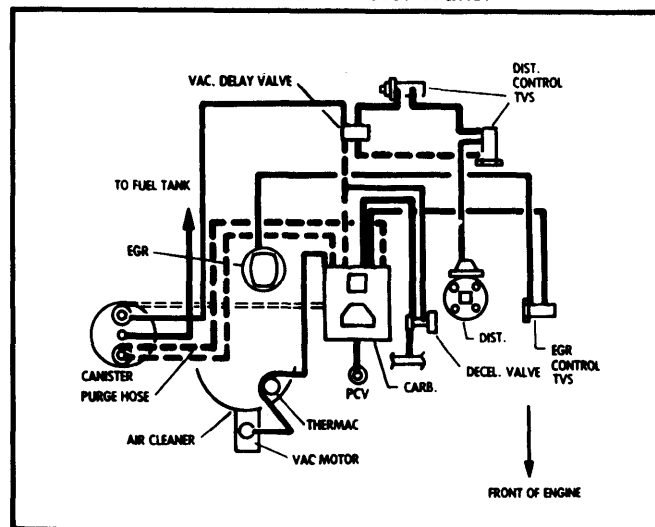
**Fig. 10 151" 4 Cyl. 2-Bbl.  
VIN 5 Federal Man. Trans.**



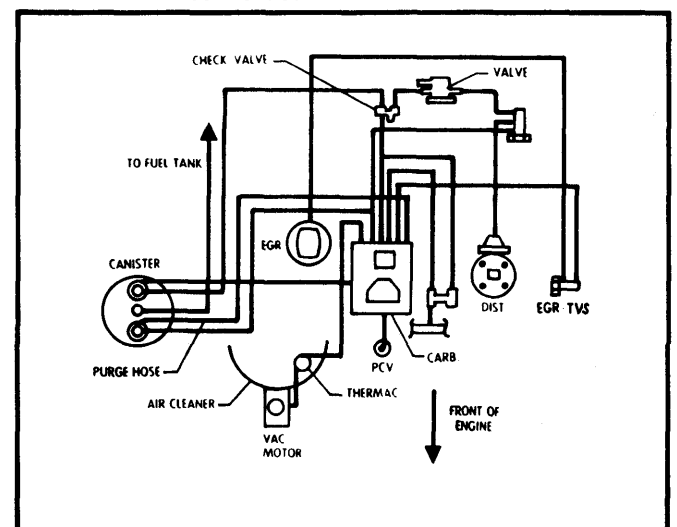
**Fig. 8 151" 4 Cyl. 2-Bbl.  
VIN V Calif. Auto. Trans.**



**Fig. 11 151" 4 Cyl. 2-Bbl.  
VIN 5 Federal Auto. Trans.**



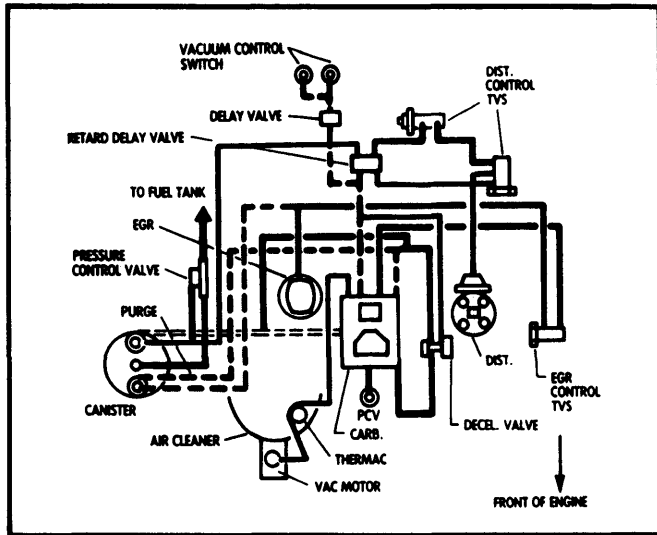
**Fig. 9 151" 4 Cyl. 2-Bbl.  
VIN 5 Federal Man. Trans.**



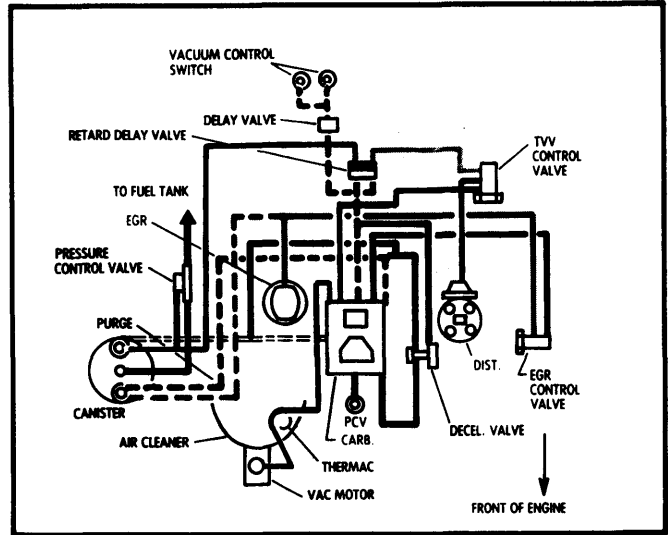
**Fig. 12 151" 4 Cyl. 2-Bbl.  
VIN 5 Federal Auto. Trans.**

# 1980 Exhaust Emission Systems

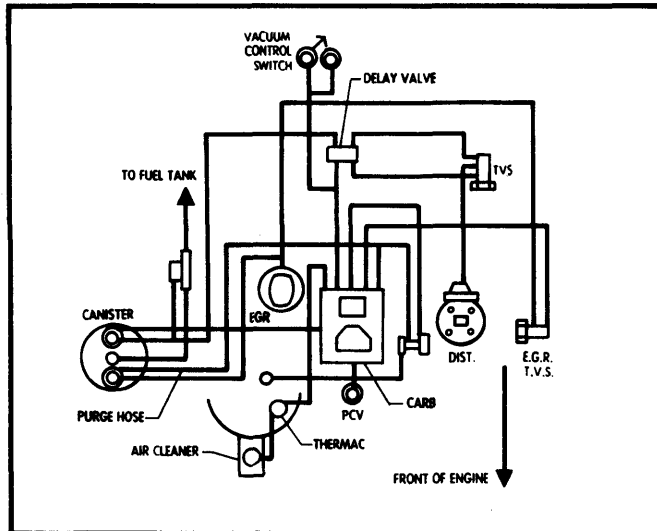
## GENERAL MOTORS VACUUM DIAGRAMS (Cont.)



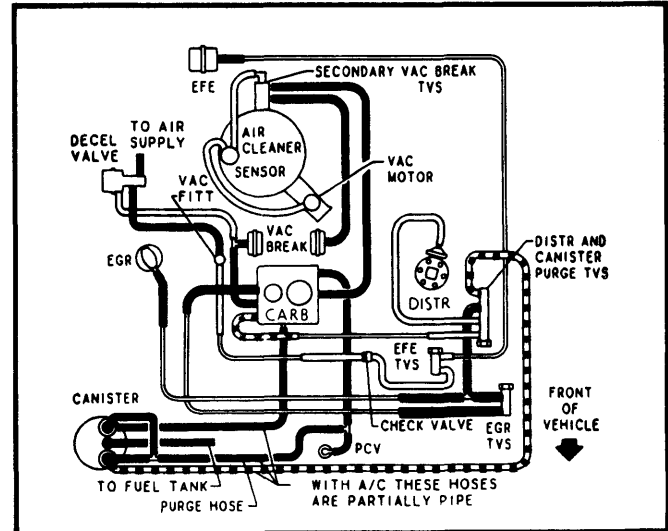
**Fig. 13 151" 4 Cyl. 2-Bbl.  
VIN 5 Calif. Man. Trans.**



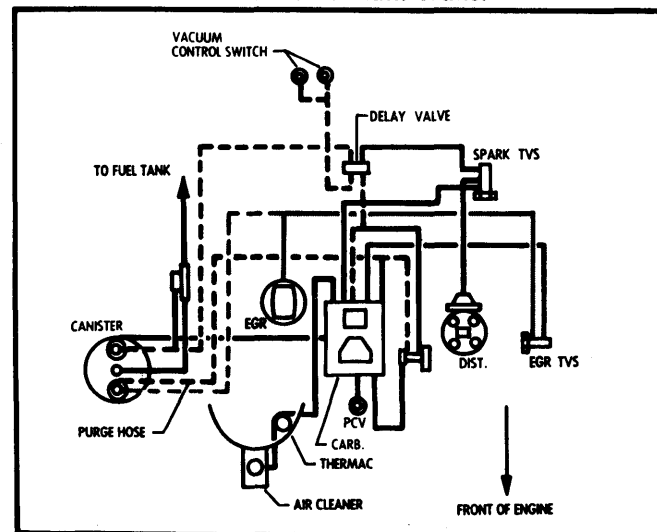
**Fig. 16 151" 4 Cyl. 2-Bbl.  
VIN 5 Calif. Auto. Trans.**



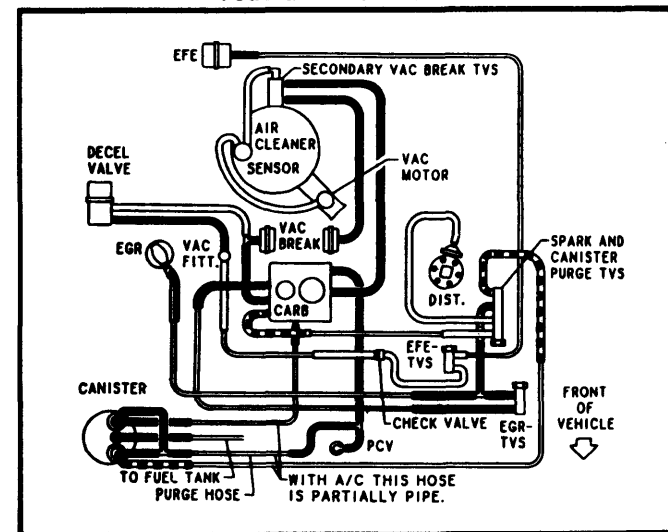
**Fig. 14 151" 4 Cyl. 2-Bbl.  
VIN 5 Calif. Man. Trans.**



**Fig. 17 173" V6 2-Bbl.  
Federal Auto. Trans.**

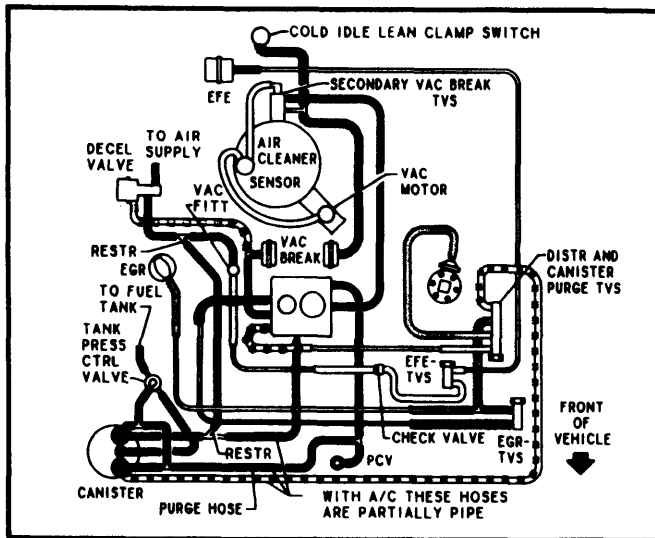


**Fig. 15 151" 4 Cyl. 2-Bbl.  
VIN 5 Calif. Auto. Trans.**

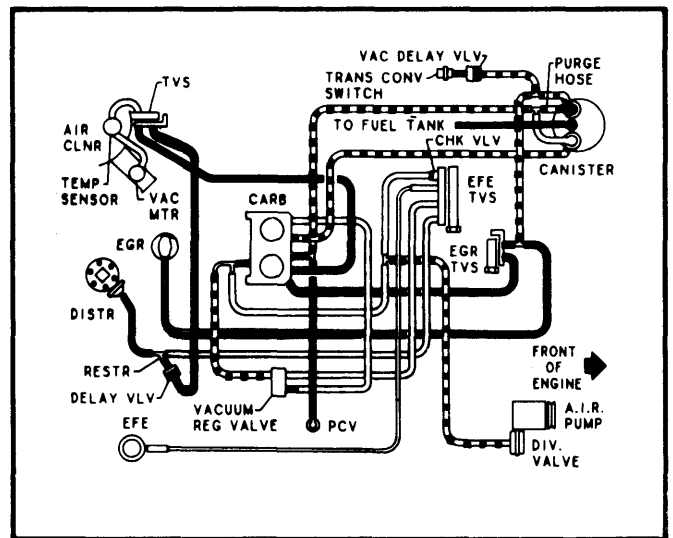


**Fig. 18 173" V6 2-Bbl.  
Federal Auto. Trans.**

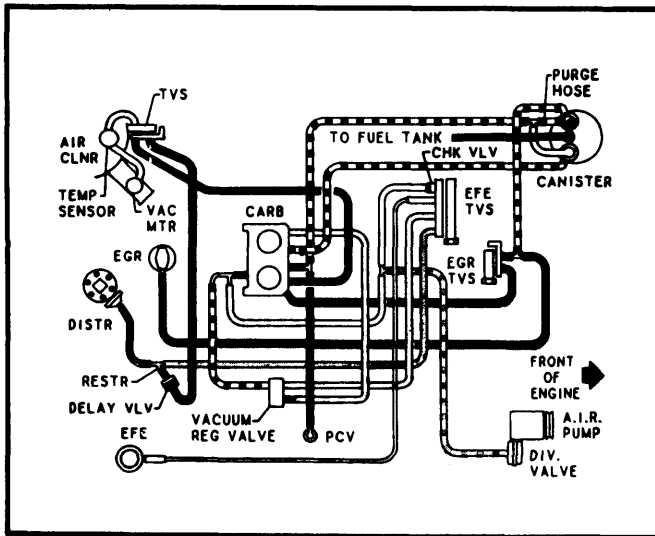
## GENERAL MOTORS VACUUM DIAGRAMS (Cont.)



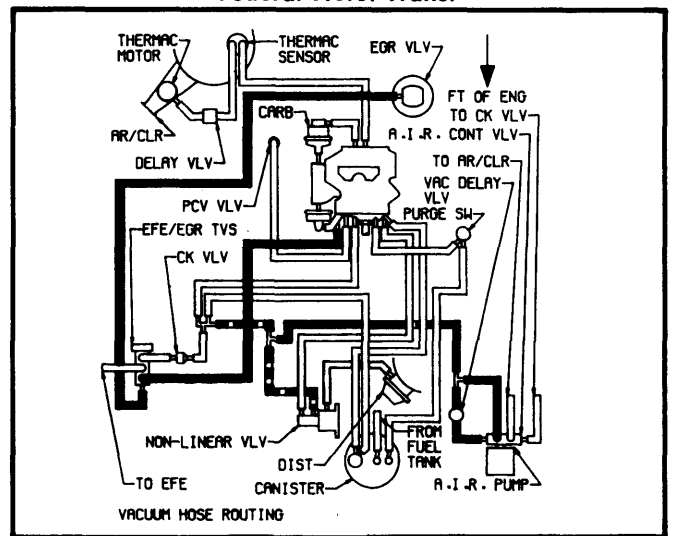
**Fig. 19** 173" V6 2-Bbl.  
Calif. Auto. Trans.



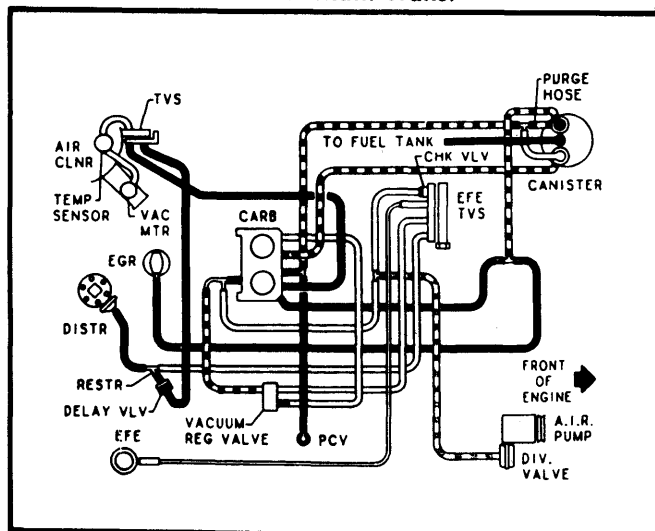
**Fig. 22** 229" V6 2-Bbl.  
Federal Auto. Trans.



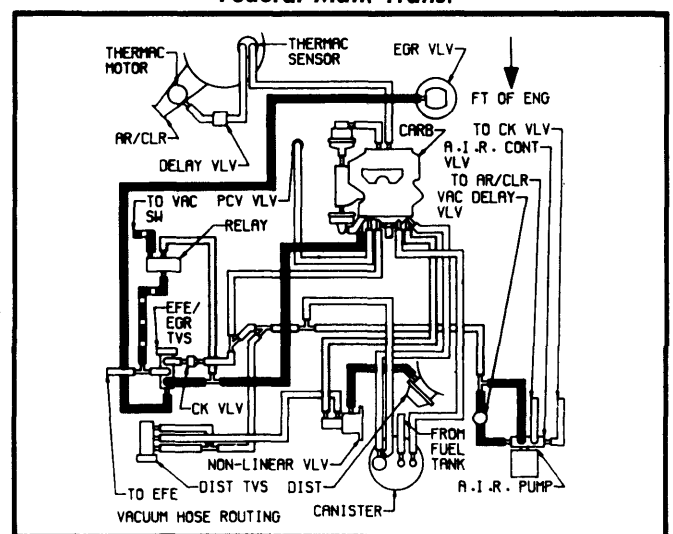
**Fig. 20** 229" V6 2-Bbl.  
Federal Man. Trans.



**Fig. 23** 231" V6 2-Bbl.  
Federal Man. Trans.



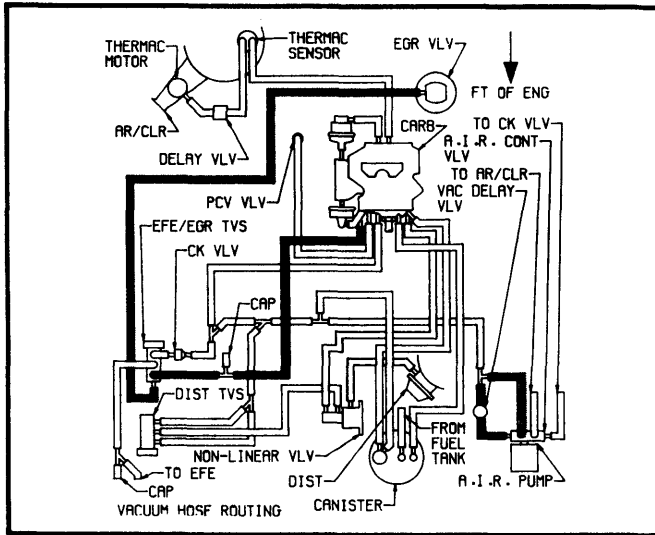
**Fig. 21** 229" V6 2-Bbl.  
Federal Auto. Trans.



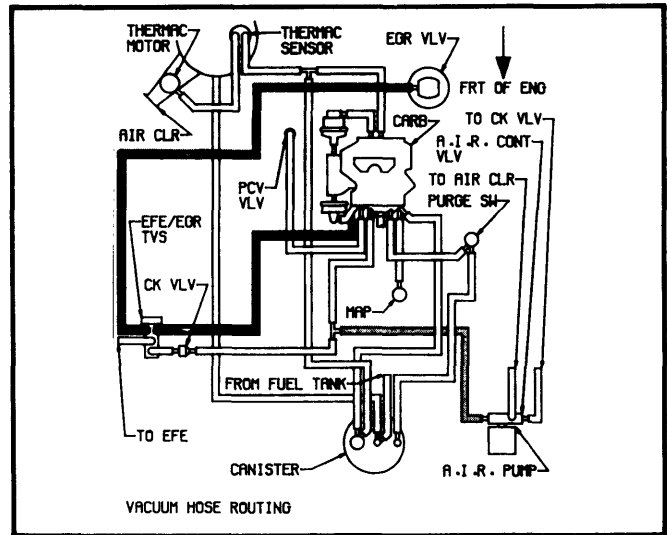
**Fig. 24** 231" V6 2-Bbl.  
Federal Auto. Trans.

# 1980 Exhaust Emission Systems

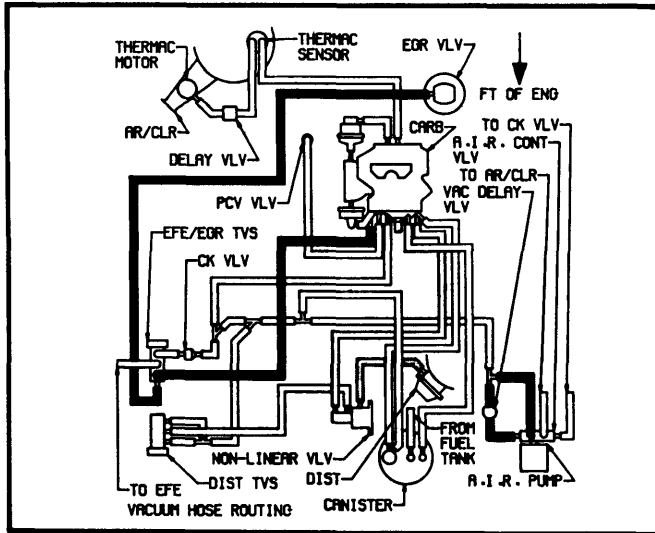
## GENERAL MOTORS VACUUM DIAGRAMS (Cont.)



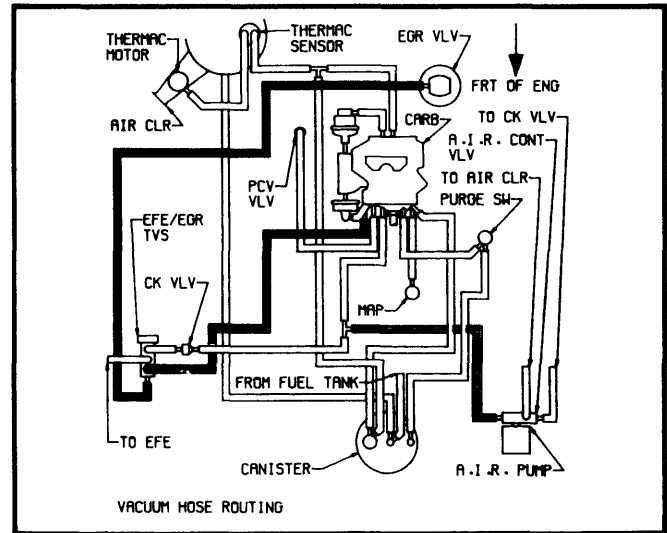
**Fig. 25 231" V6 2-Bbl.  
Federal Auto. Trans.**



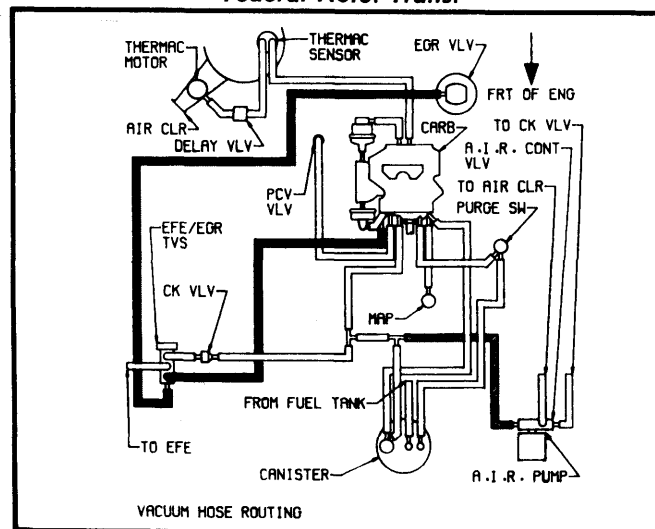
**Fig. 28 231" V6 2-Bbl.  
Calif. Man. Trans.**



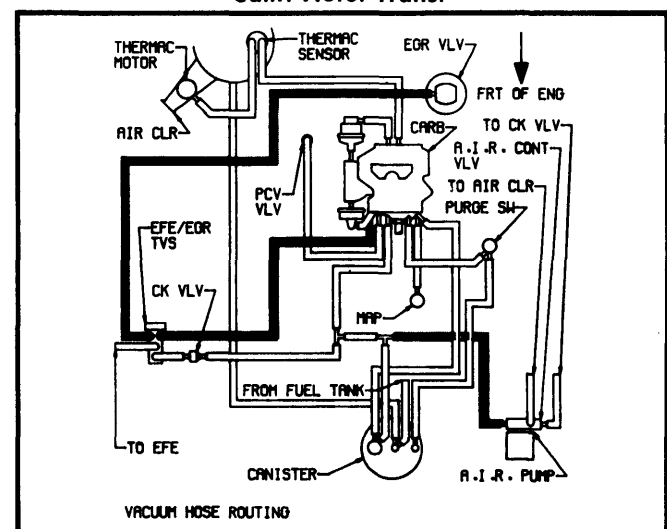
**Fig. 26 231" V6 2-Bbl.  
Federal Auto. Trans.**



**Fig. 29 231" V6 2-Bbl.  
Calif. Auto. Trans.**

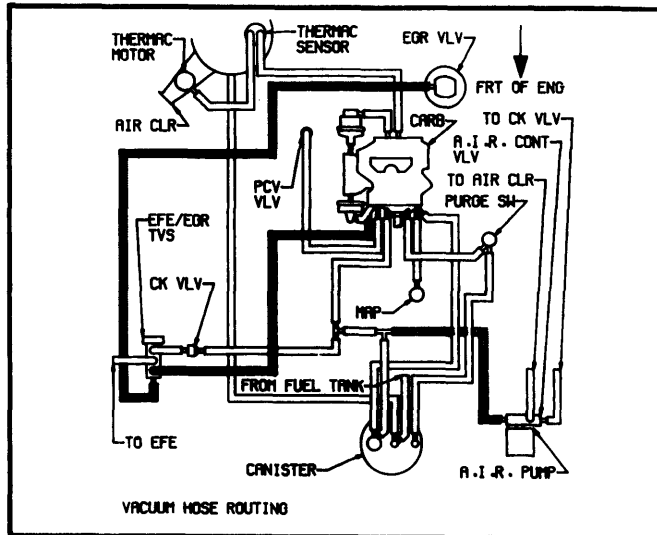


**Fig. 27 231" V6 2-Bbl.  
Federal Auto. Trans. W/C-A**

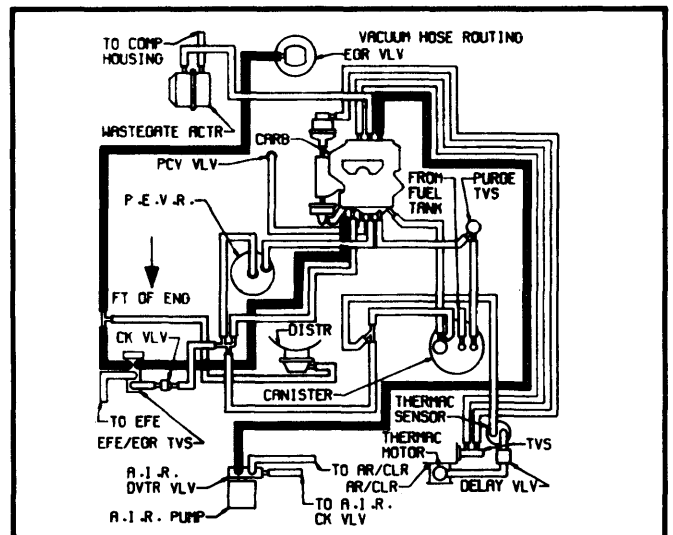


**Fig. 30 231" V6 2-Bbl.  
Calif. Auto. Trans.**

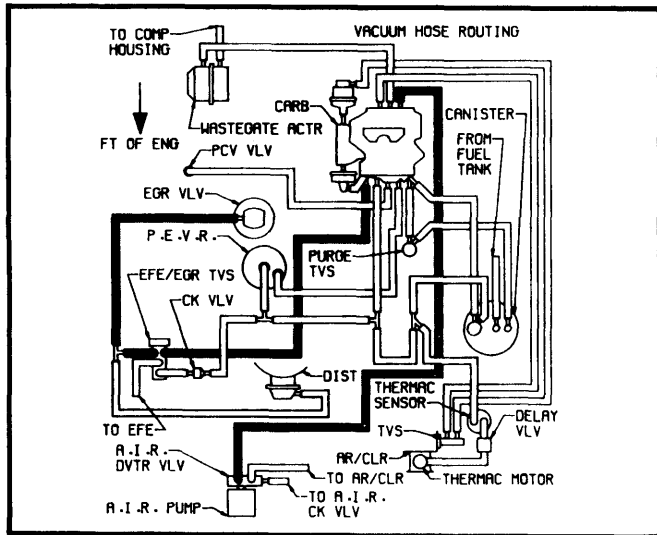
## GENERAL MOTORS VACUUM DIAGRAMS (Cont.)



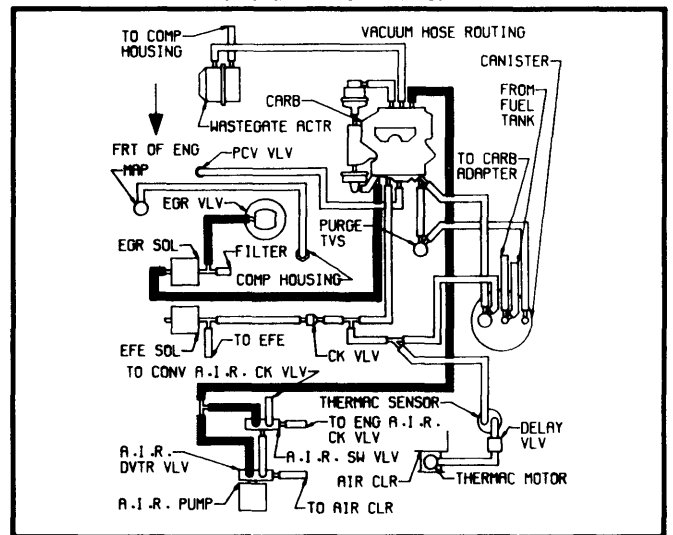
**Fig. 31 231" V6 2-Bbl.  
Calif. Auto. Trans.**



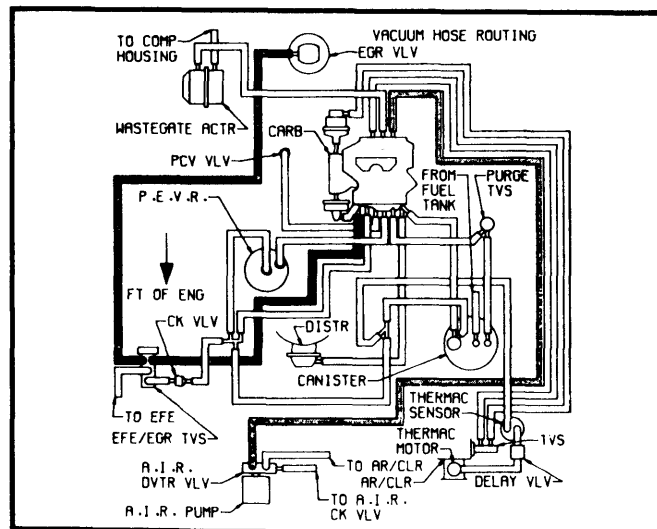
**Fig. 34 231" V6 Turbo  
Federal Auto. Trans.**



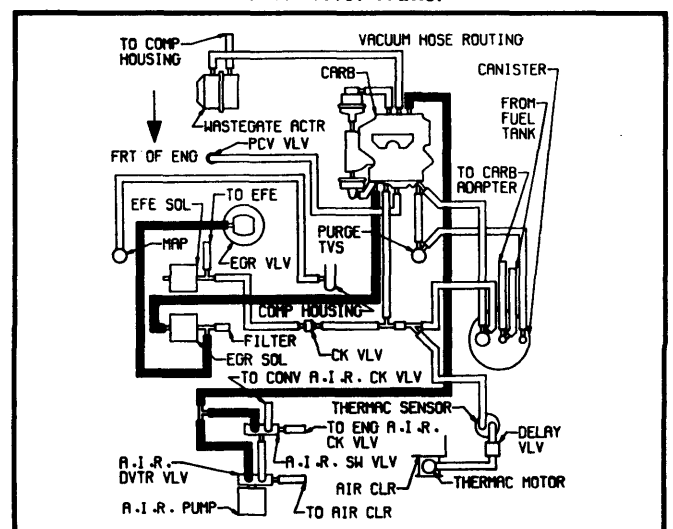
**Fig. 32 231" V6 Turbo  
Federal Auto. Trans.**



**Fig. 35 231" V6 Turbo  
Calif. Auto. Trans.**



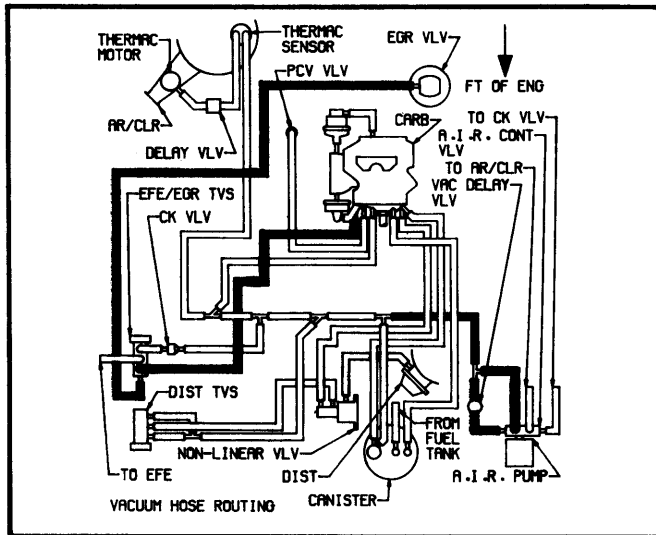
**Fig. 33 231" V6 Turbo  
Federal Auto. Trans.**



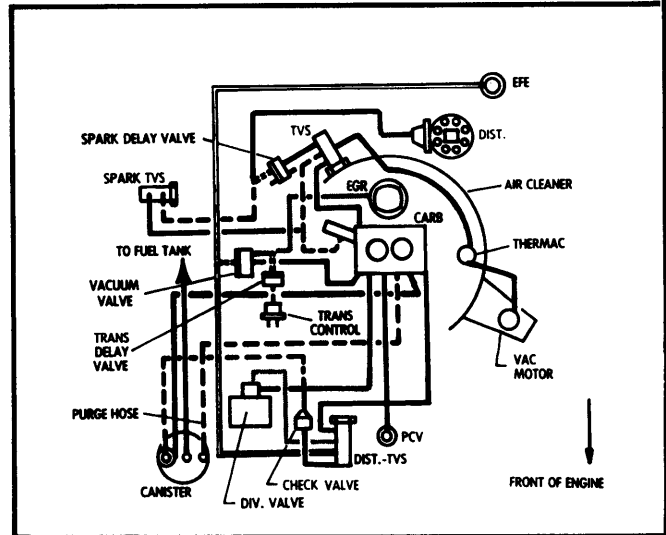
**Fig. 36 231" V6 Turbo  
Calif. Auto. Trans.**

# 1980 Exhaust Emission Systems

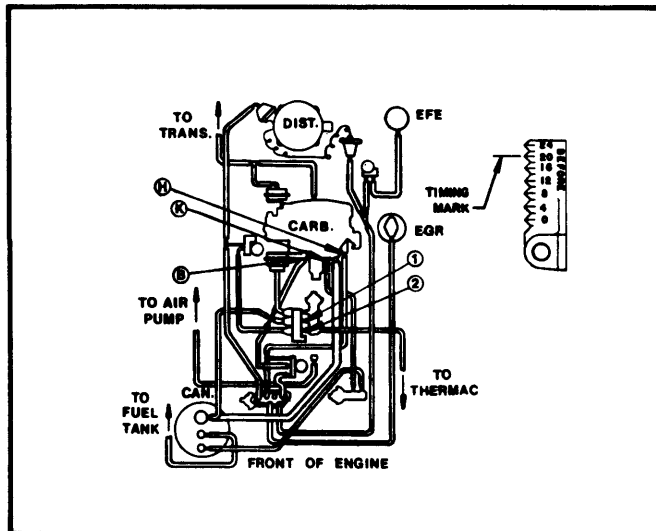
## GENERAL MOTORS VACUUM DIAGRAMS (Cont.)



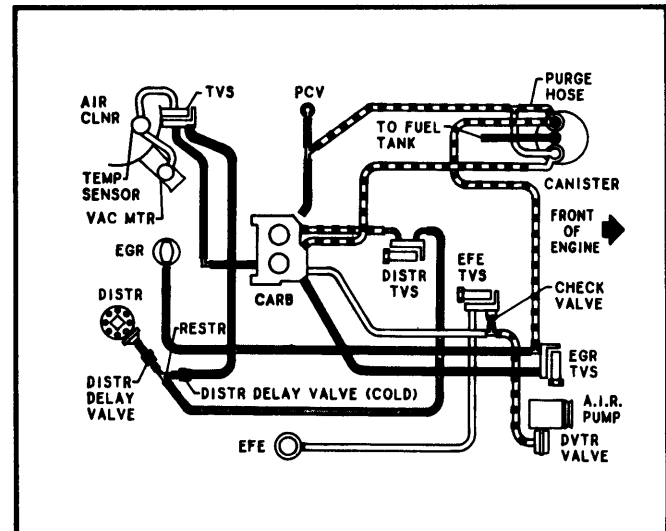
**Fig. 37 252" V6 4-Bbl.**  
Federal Auto. Trans.



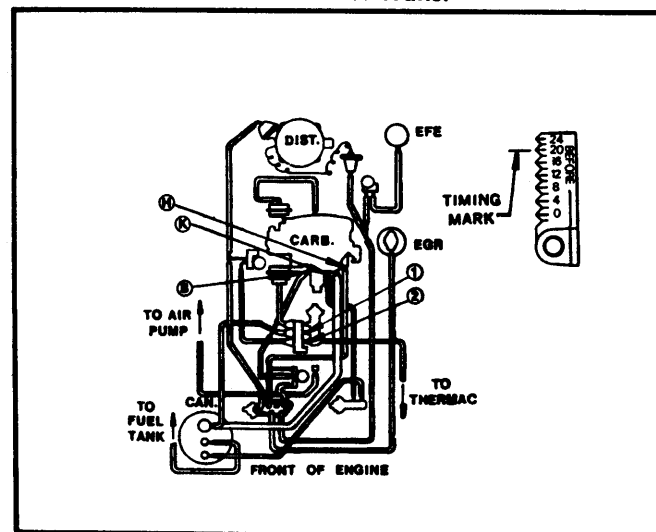
**Fig. 40 265" V8 2-Bbl.**  
Federal Auto. Trans.



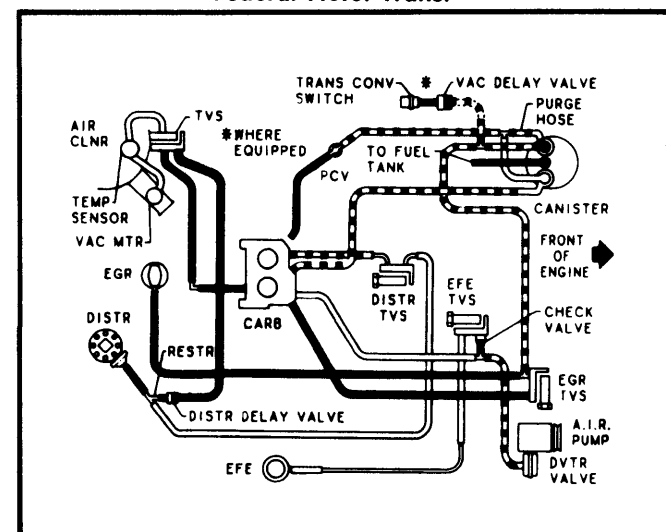
**Fig. 38 260" V8 2-Bbl.**  
Federal Auto. Trans.



**Fig. 41 267" V8 2-Bbl.**  
Federal Auto. Trans.

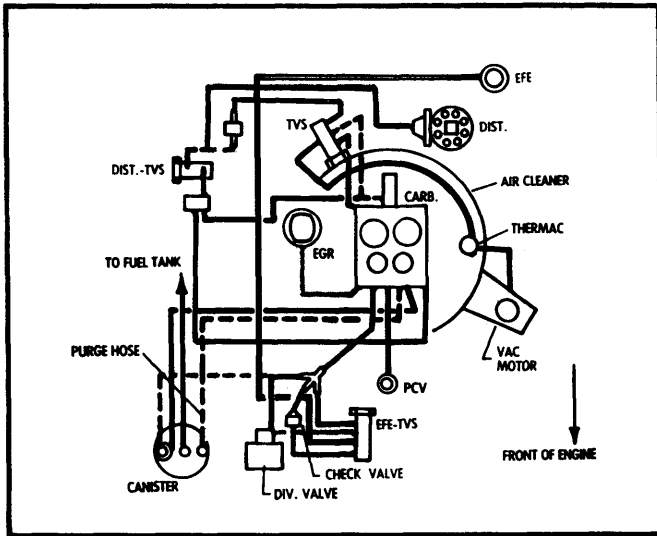


**Fig. 39 260" V8 2-Bbl.**  
Federal Auto. Trans.

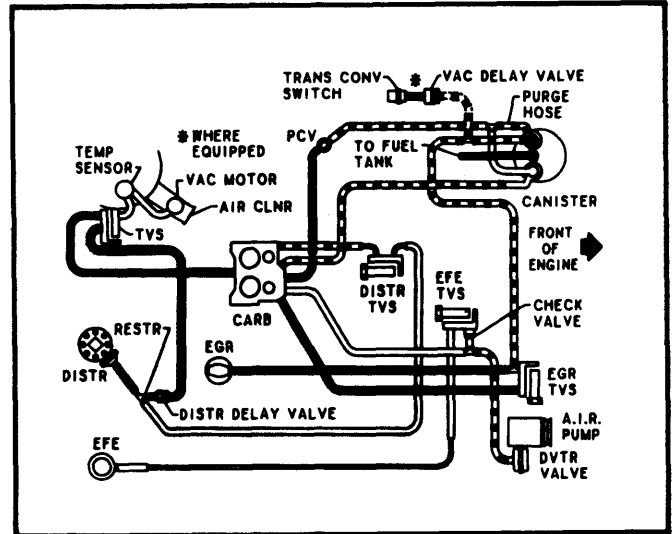


**Fig. 42 267" V8 2-Bbl.**  
Federal Auto. Trans.

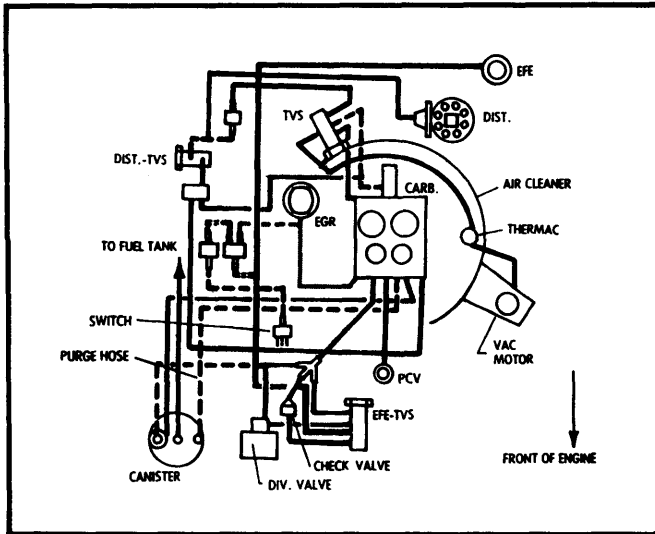
## GENERAL MOTORS VACUUM DIAGRAMS (Cont.)



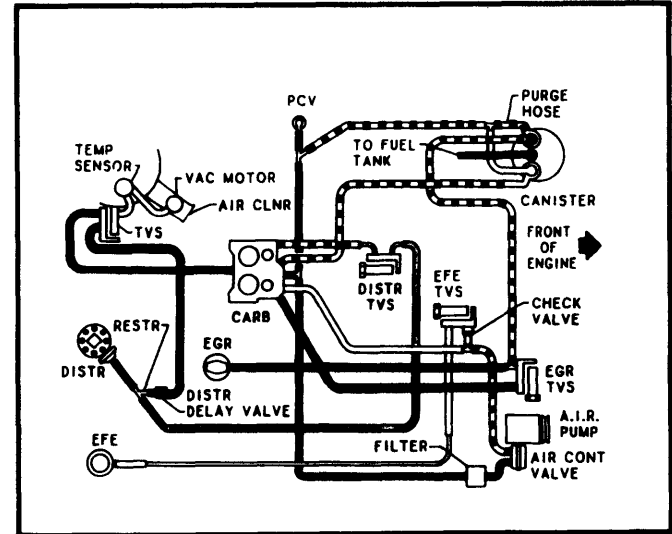
**Fig. 43 301" V8 4-Bbl.**  
Federal Auto. Trans.



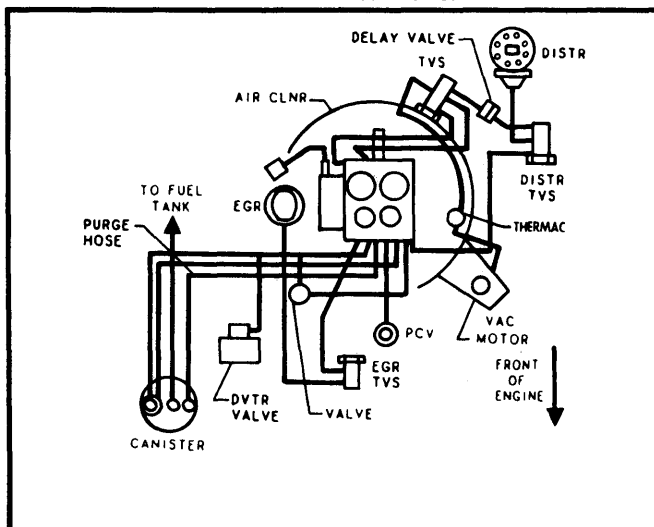
**Fig. 46 305" V8 4-Bbl.**  
Federal Auto. Trans.



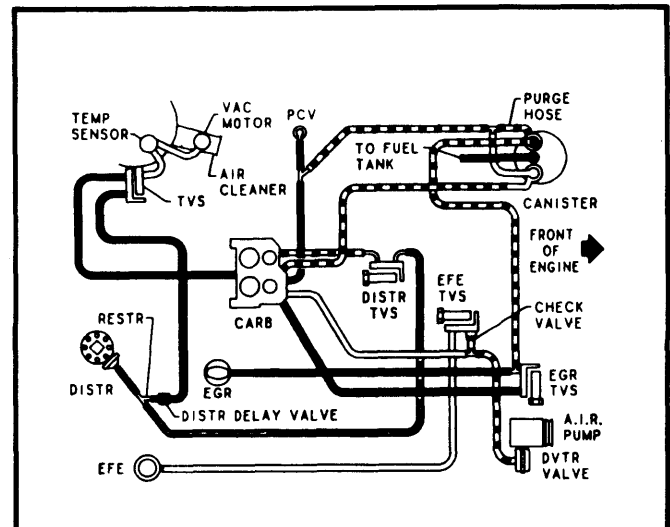
**Fig. 44 301" V8 4-Bbl.**  
Federal Auto. Trans.



**Fig. 47 305" V8 4-Bbl.**  
Federal Man. Trans.



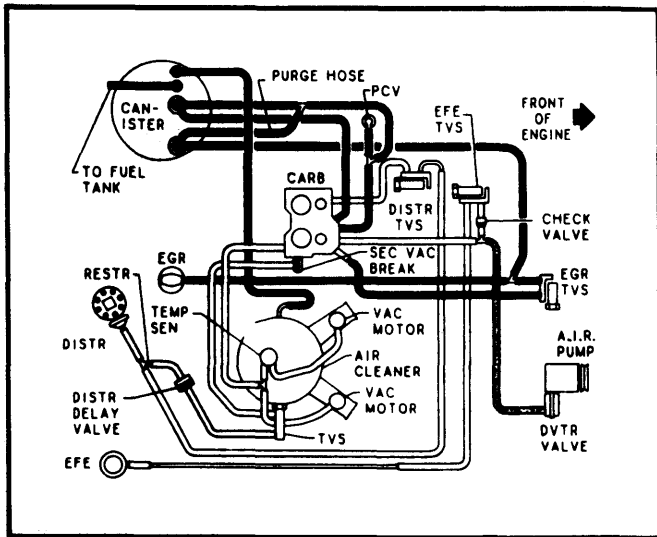
**Fig. 45 301" V8 Turbo**  
Federal Auto. Trans.



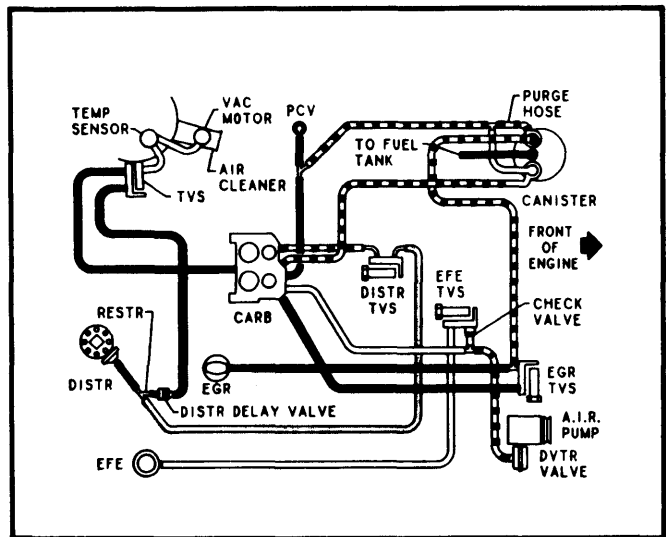
**Fig. 48 305" & 350" V8 4-Bbl.**  
Federal Man. Trans.

# 1980 Exhaust Emission Systems

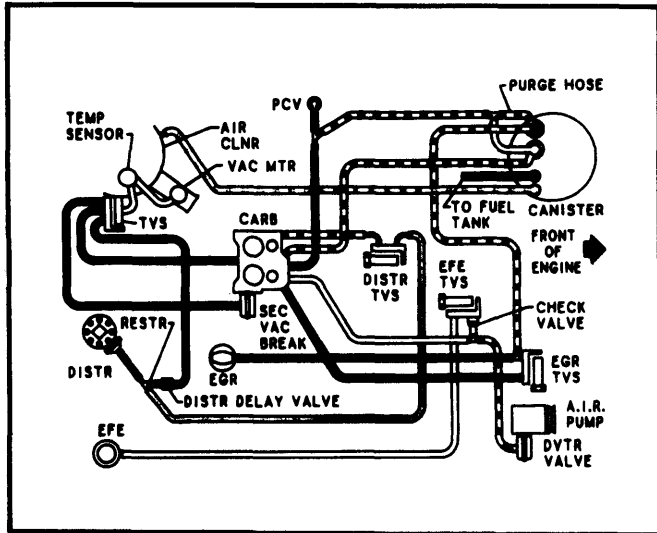
## GENERAL MOTORS VACUUM DIAGRAMS (Cont.)



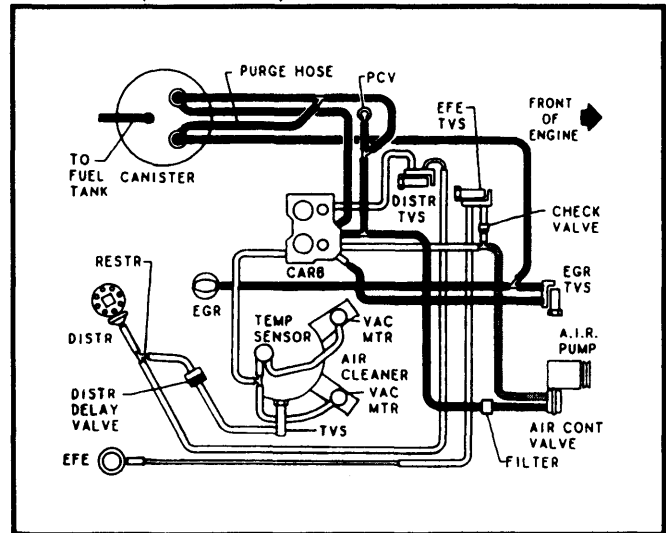
**Fig. 49** 305" V8 4-Bbl.  
Calif. Auto. Trans.



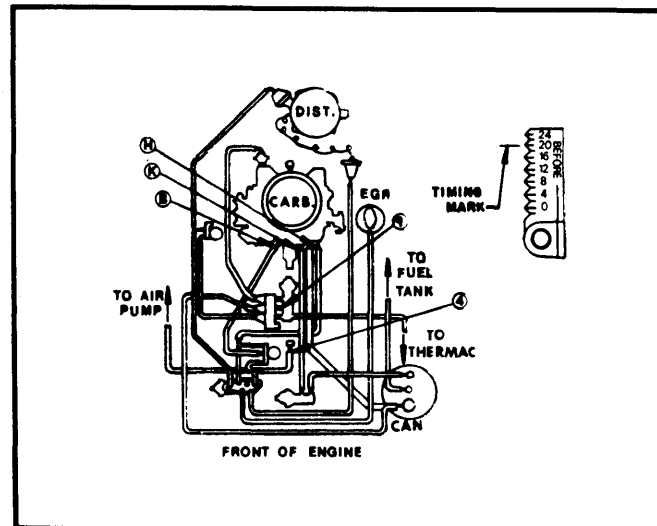
**Fig. 52** 305" & 350" V8 4-Bbl.  
(VIN H & L) Federal Auto. Trans.



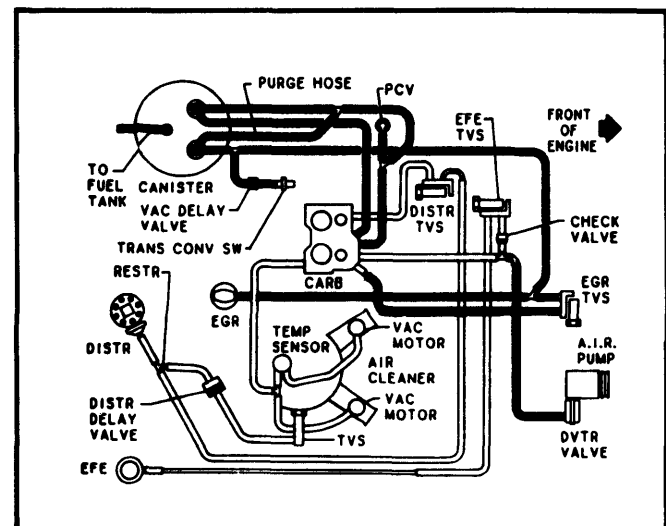
**Fig. 50** 305" V8 4-Bbl.  
Calif. Man. Trans.



**Fig. 53** 350" V8 4-Bbl.  
VIN 6 & 8 Federal Man. Trans.

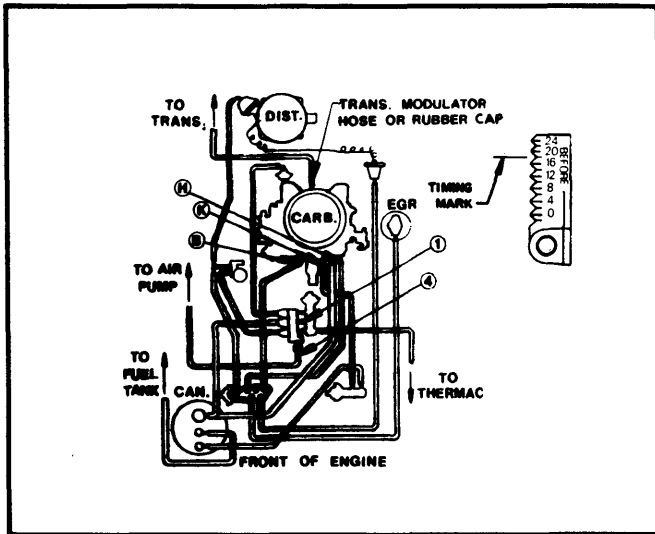


**Fig. 51** 307" V8 4-Bbl.  
Federal Auto. Trans.

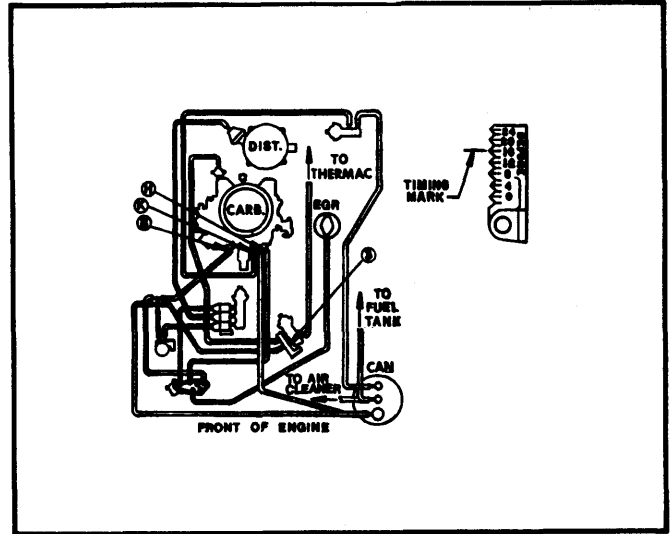


**Fig. 54** 350" V8 4-Bbl.  
VIN 6 & 8 Federal Auto. Trans.

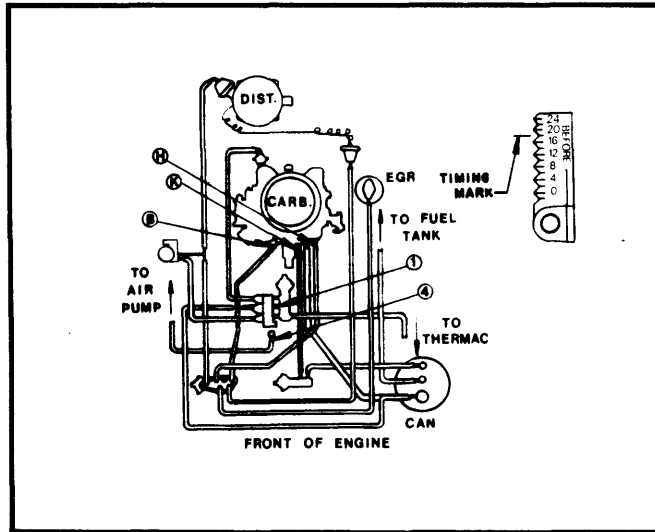
## GENERAL MOTORS VACUUM DIAGRAMS (Cont.)



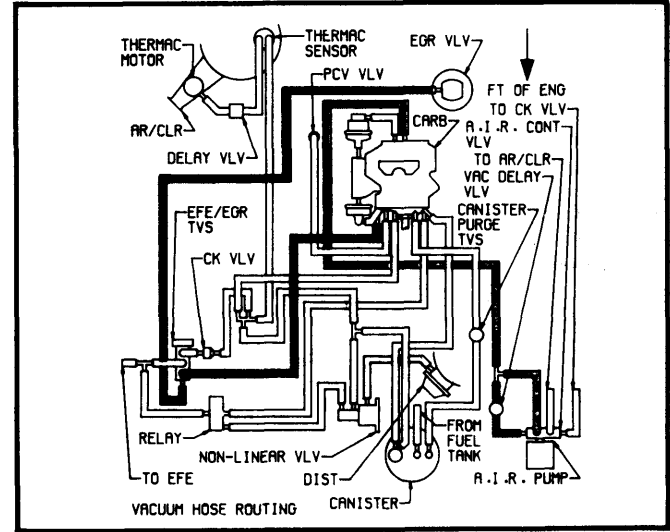
**Fig. 55 350" V8 4-Bbl.  
VIN R Federal Auto. Trans.**



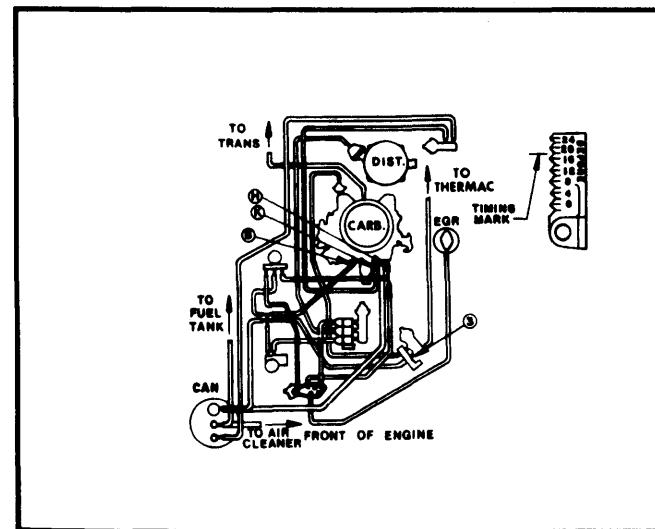
**Fig. 58 350" V8 4-Bbl.  
VIN R Calif. Auto. Trans.**



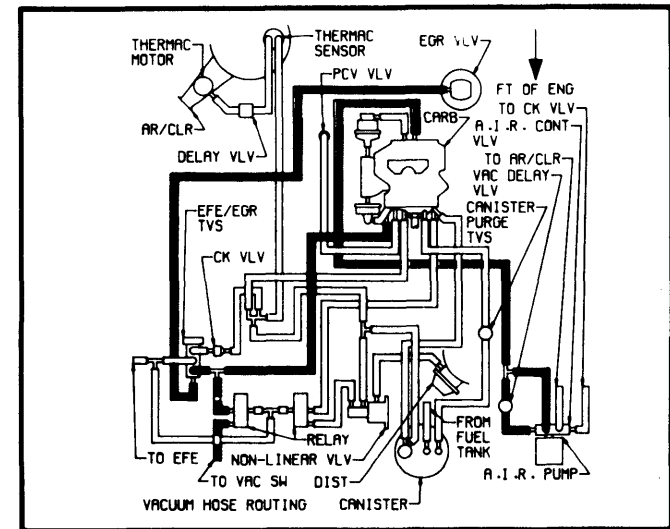
**Fig. 56 350" V8 4-Bbl.  
VIN R Federal Auto. Trans.**



**Fig. 59 350" V8 4-Bbl.  
VIN X Federal Auto. Trans.**



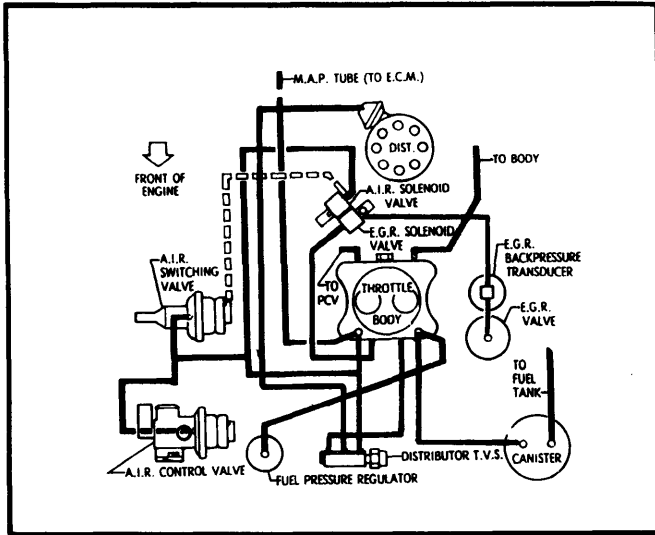
**Fig. 57 350" V8 4-Bbl.  
VIN R Calif. Auto. Trans.**



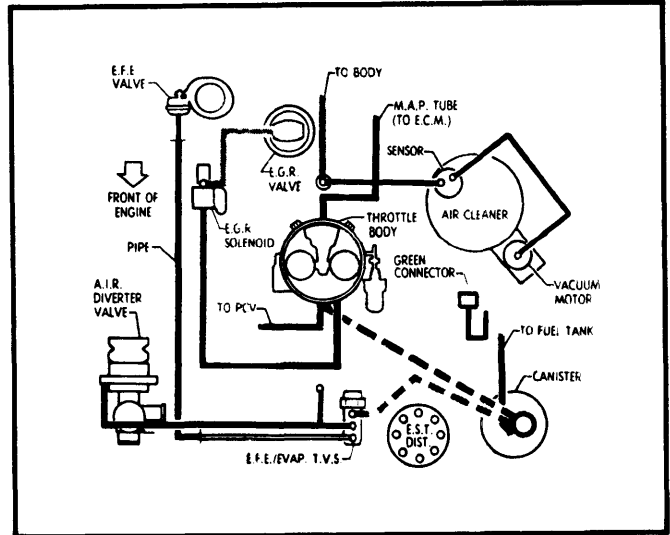
**Fig. 60 350" V8 4-Bbl.  
VIN X Federal Auto. Trans.**

# 1980 Exhaust Emission Systems

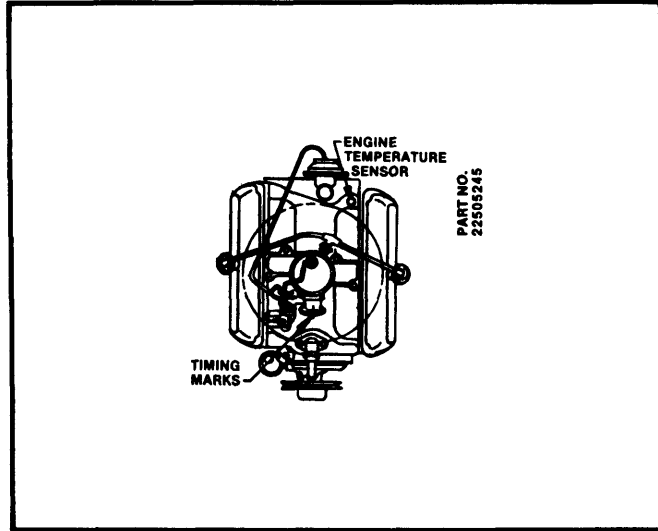
## GENERAL MOTORS VACUUM DIAGRAMS (Cont.)



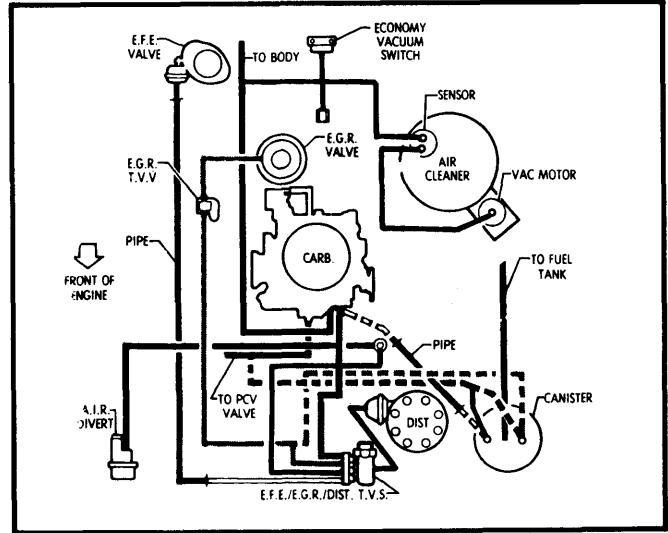
**Fig. 61 350" V8 EFI**  
Calif. Auto. Trans.



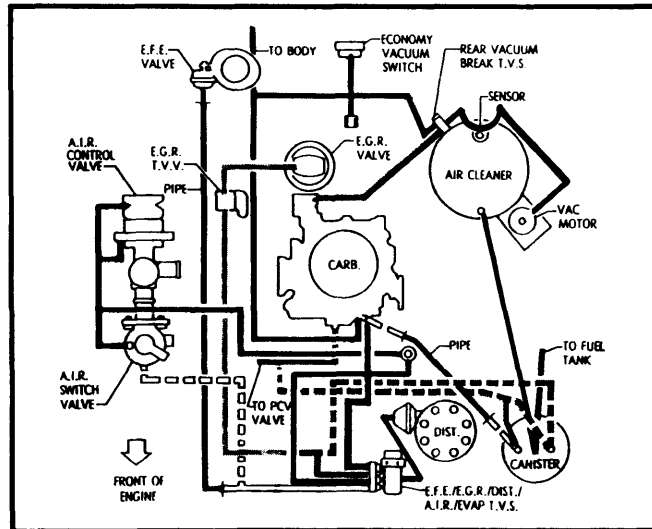
**Fig. 63 368" V8 DEFI**  
Federal Auto. Trans.



**Fig. 62 350" V8 Diesel**  
All Models



**Fig. 64 368" V8 4-Bbl.**  
Federal Auto. Trans.



**Fig. 65 368" V8 4-Bbl.**  
Calif. Auto. Trans.