

1976 EXHAUST EMISSION SYSTEMS Chrysler Corp. Vacuum Diagrams

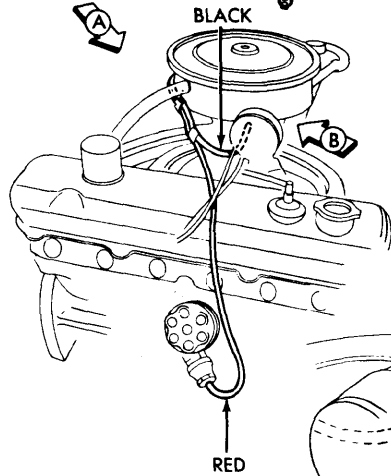

225 CID ENGINES

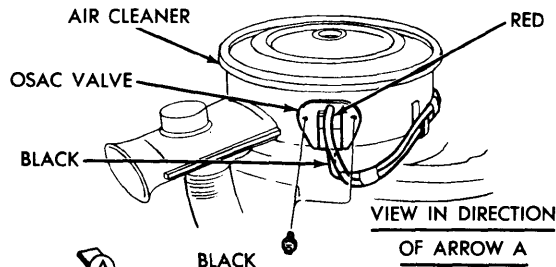
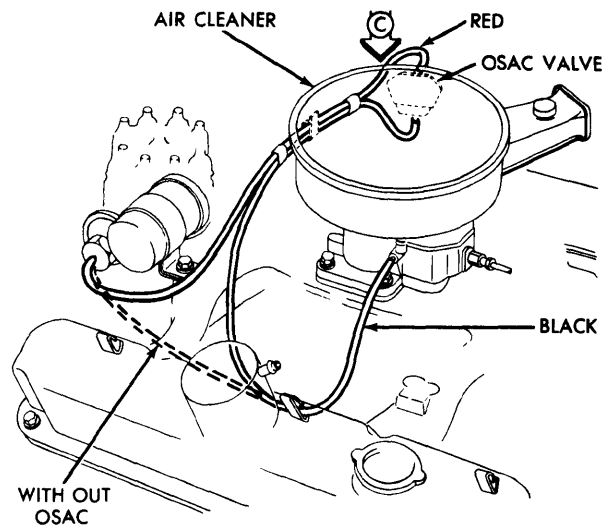
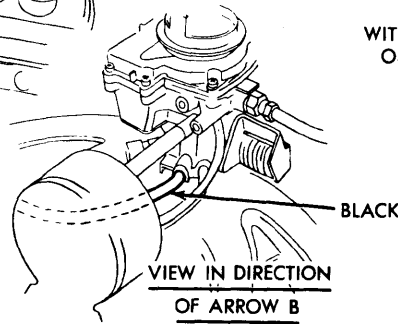

318 CID ENGINE

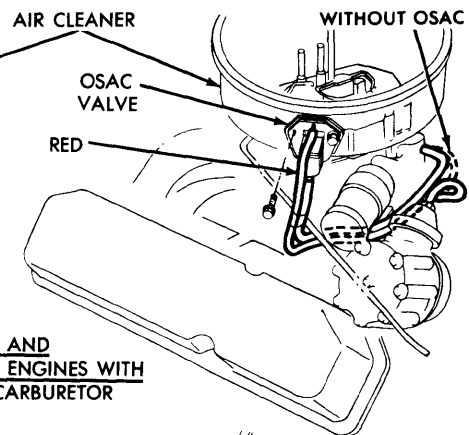
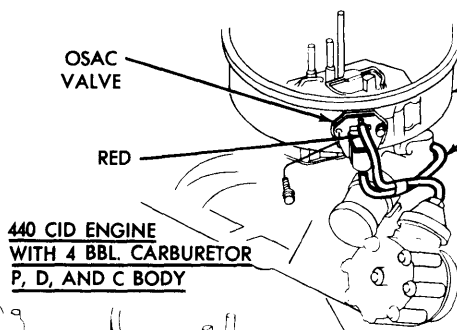
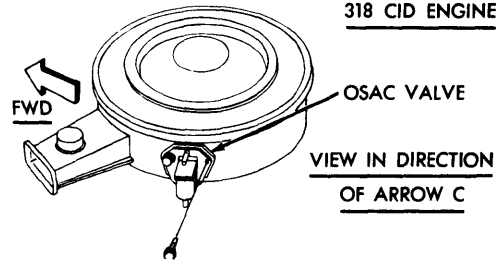

400, 440 AND 440 H.P. ENGINES WITH 4 BBL. CARBURETOR

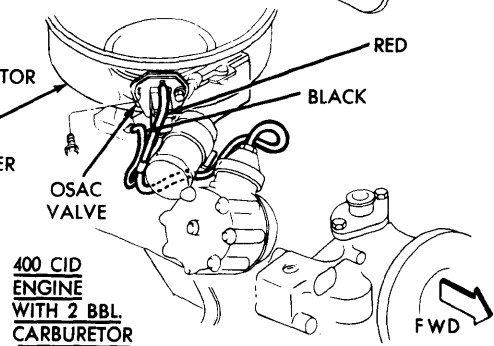
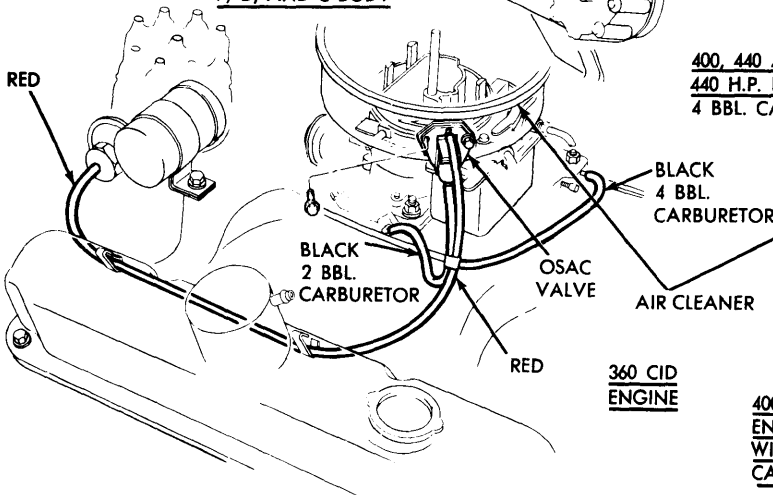

OSAC VALVE (ALL ENGINES)

1976 EXHAUST EMISSION SYSTEMS Chrysler Corp. Vacuum Diagrams (Cont.)

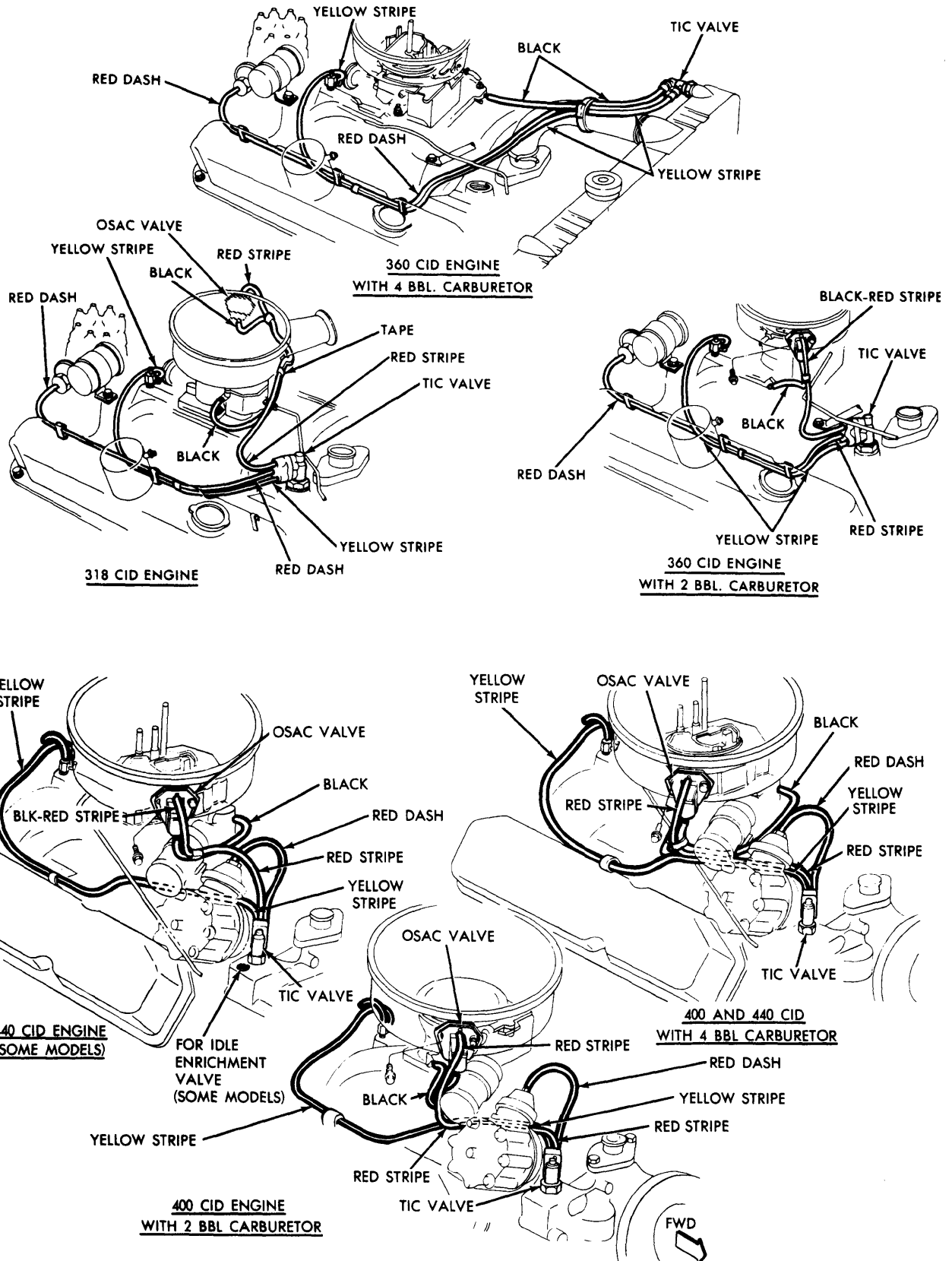

1976 EXHAUST EMISSION SYSTEMS Chrysler Corp. Vacuum Diagrams (Cont.)

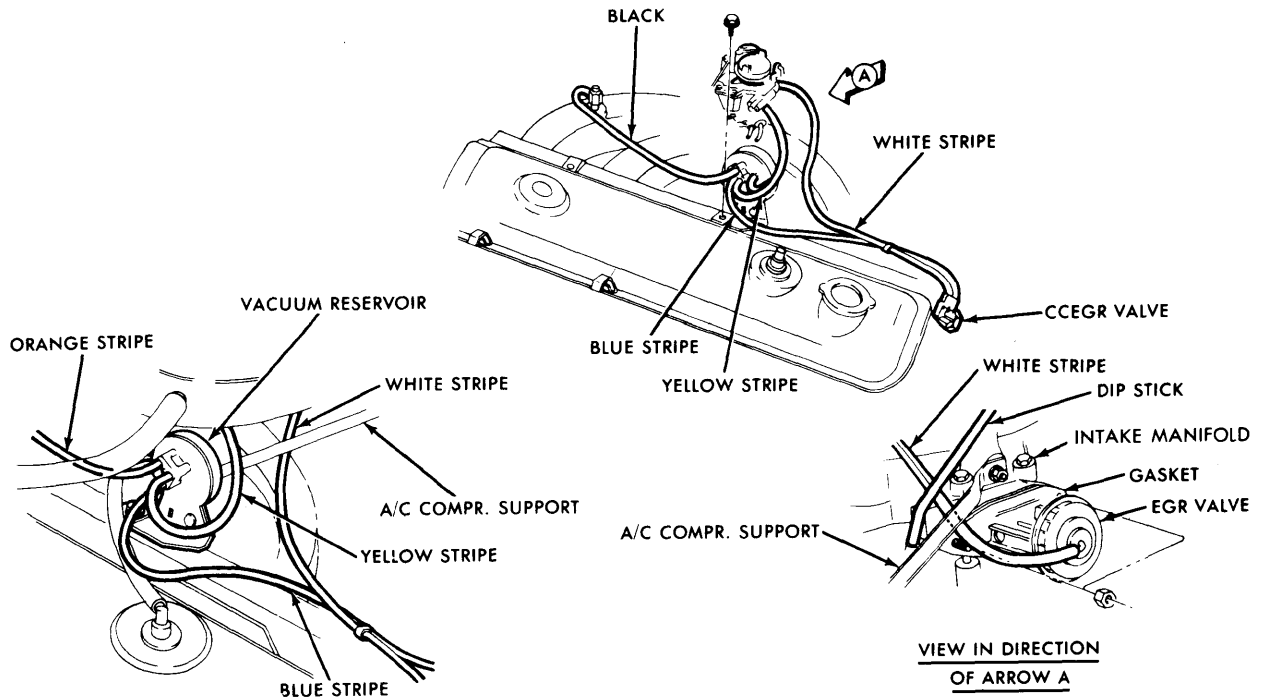

EGR SYSTEM 225" (FEDERAL)

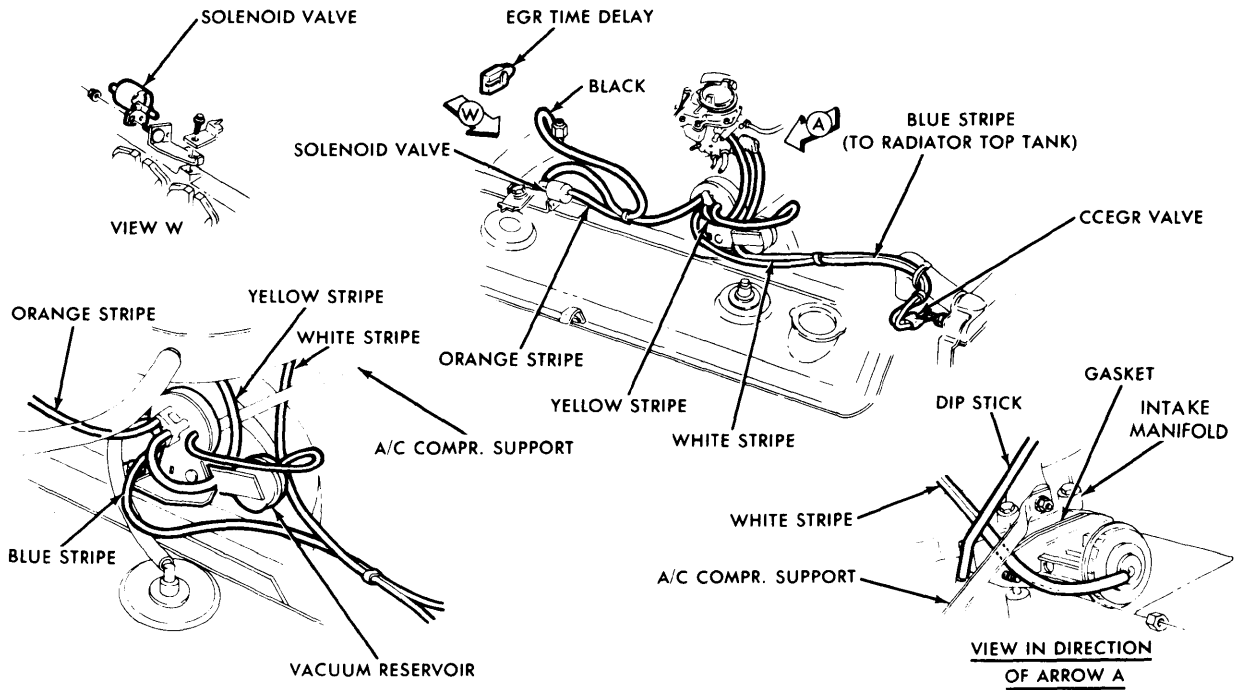

EGR SYSTEM 225" (CALIFORNIA)

1976 EXHAUST EMISSION SYSTEMS Chrysler Corp. Vacuum Diagrams (Cont.)

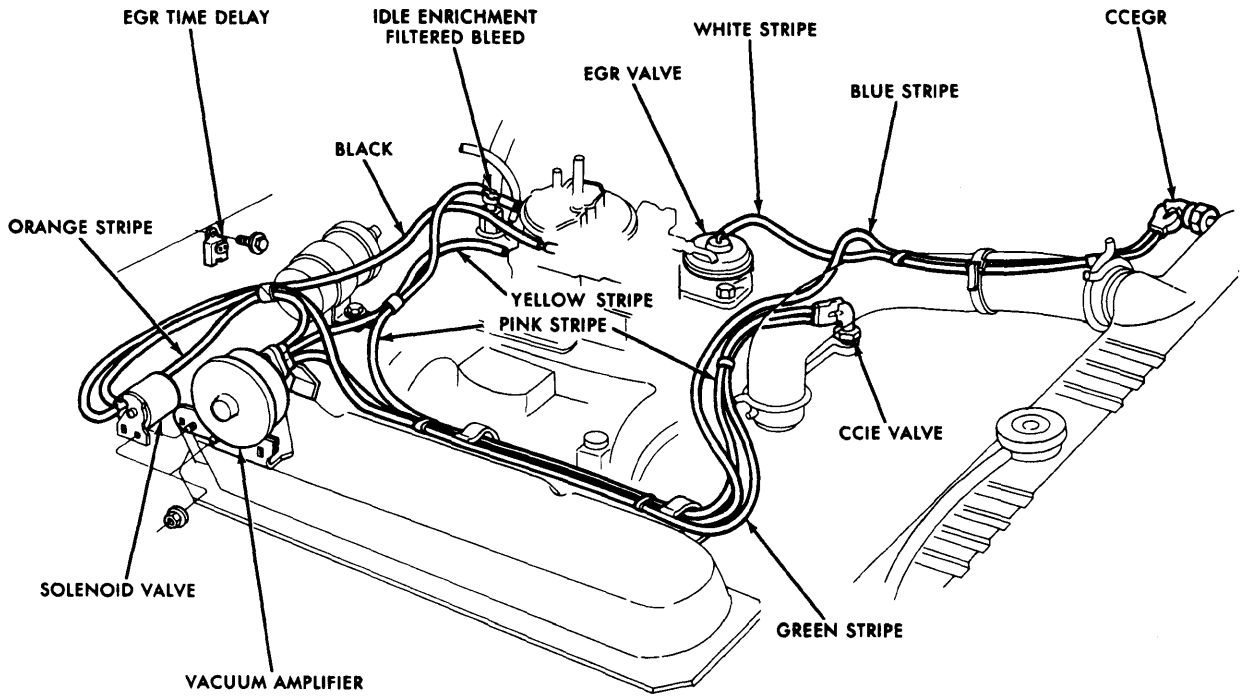

**EGR SYSTEM 318" AUTO. TRANS.
(CALIFORNIA)**

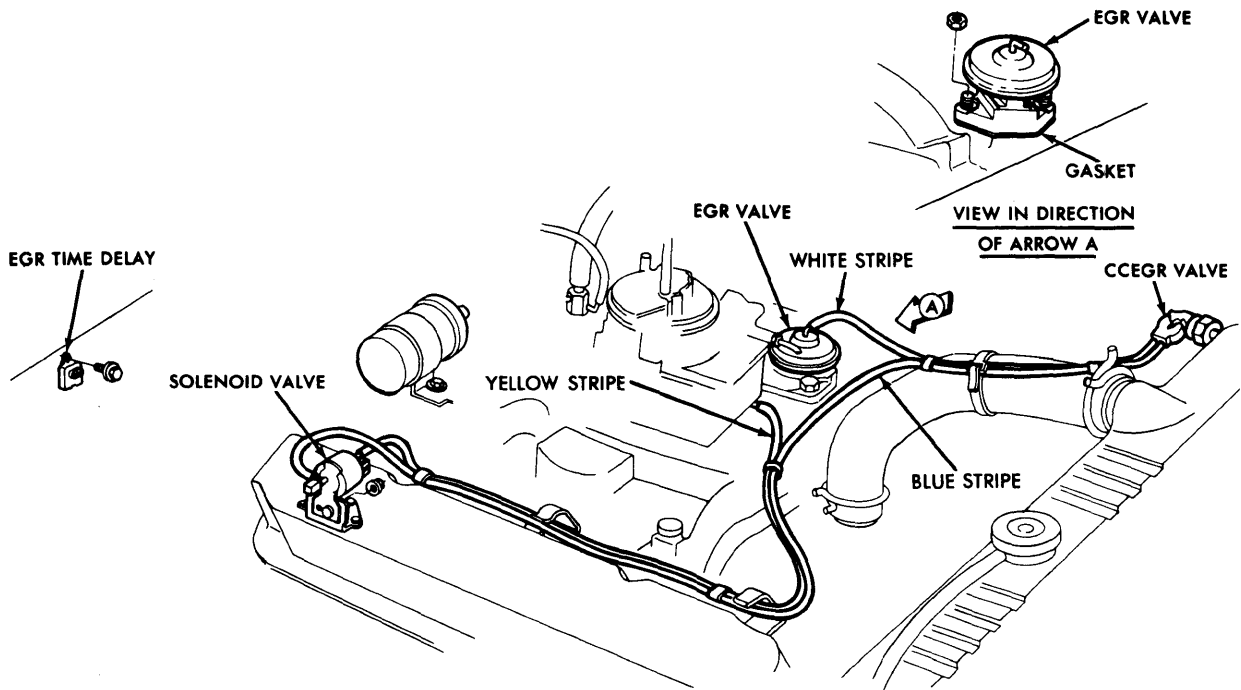

**EGR SYSTEM 318" MAN. TRANS.
(FEDERAL)**

1976 EXHAUST EMISSION SYSTEMS Chrysler Corp. Vacuum Diagrams (Cont.)

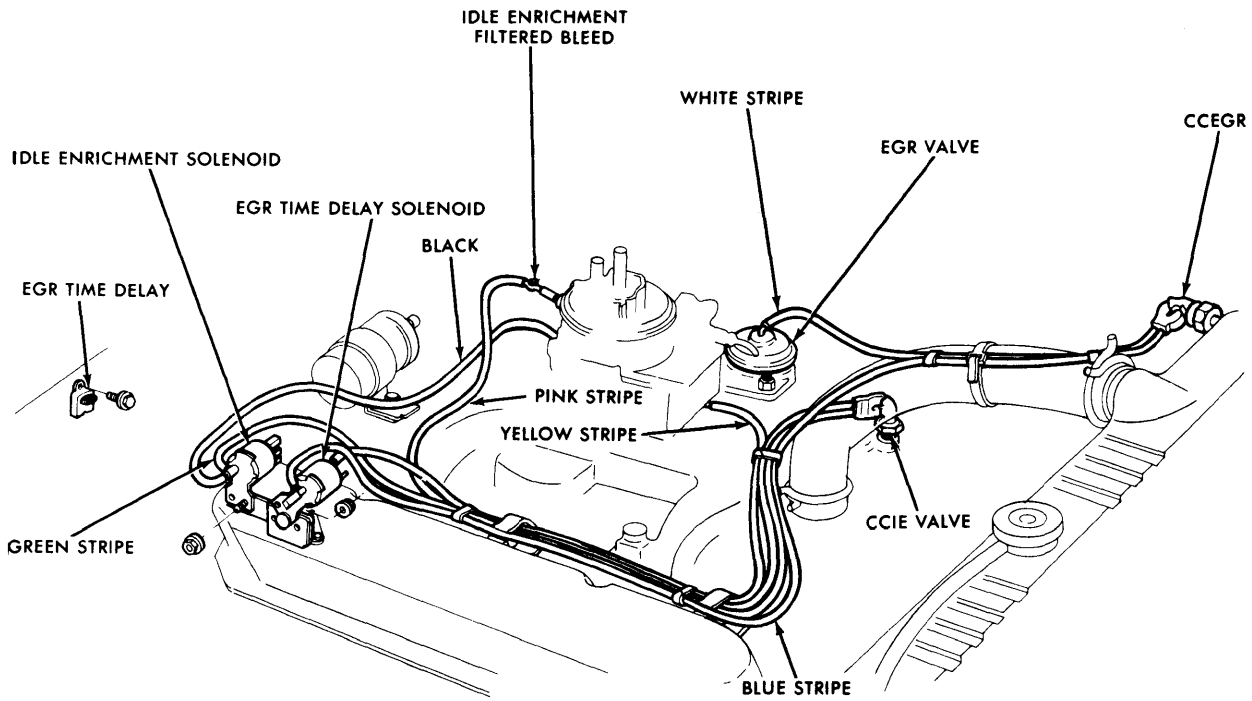

**EGR SYSTEM 318" AUTO. TRANS.
(FEDERAL)**

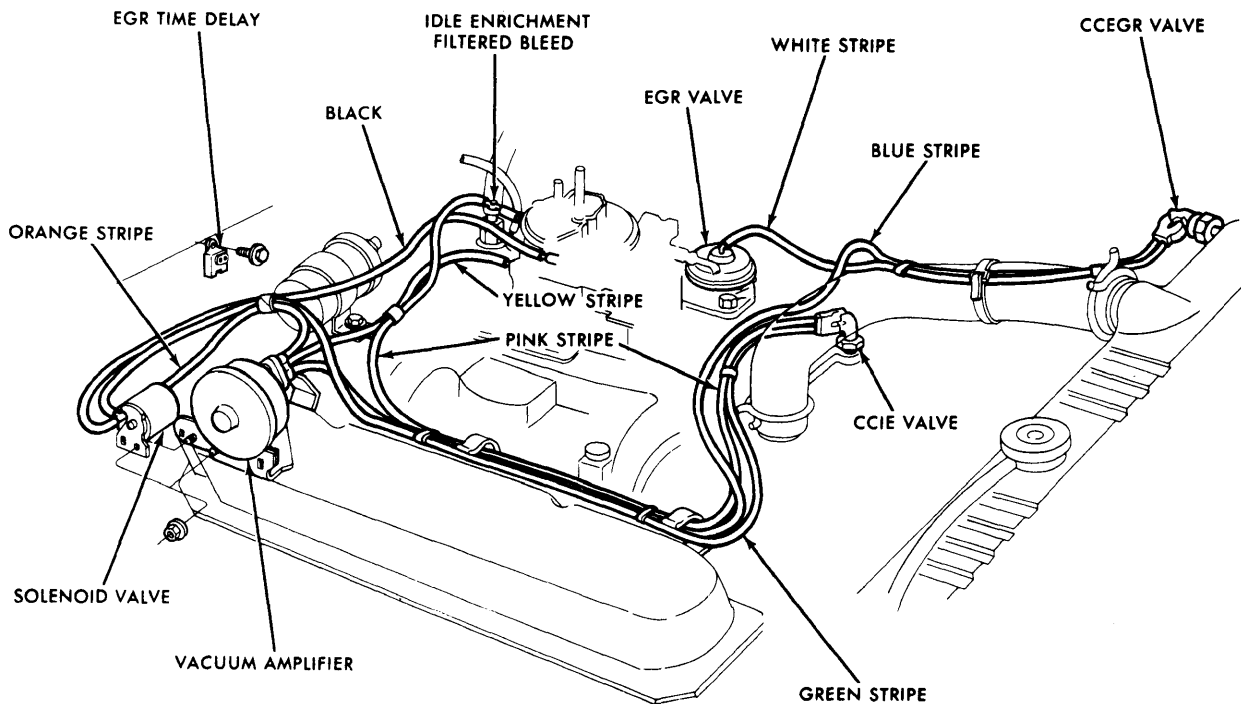

**EGR SYSTEM 360" 2-BBL. AUTO. TRANS.
(FEDERAL)**

1976 EXHAUST EMISSION SYSTEMS Chrysler Corp. Vacuum Diagrams (Cont.)

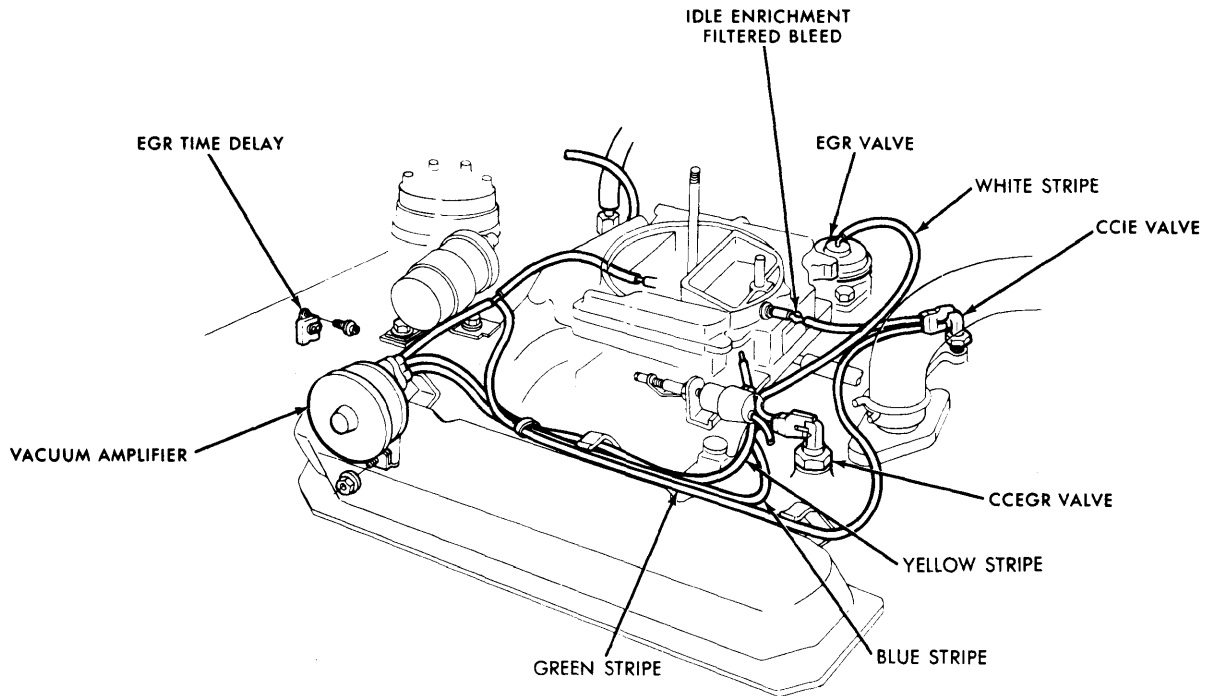

**EGR SYSTEM 360" 4-BBL. AUTO TRANS.
(CALIFORNIA)**

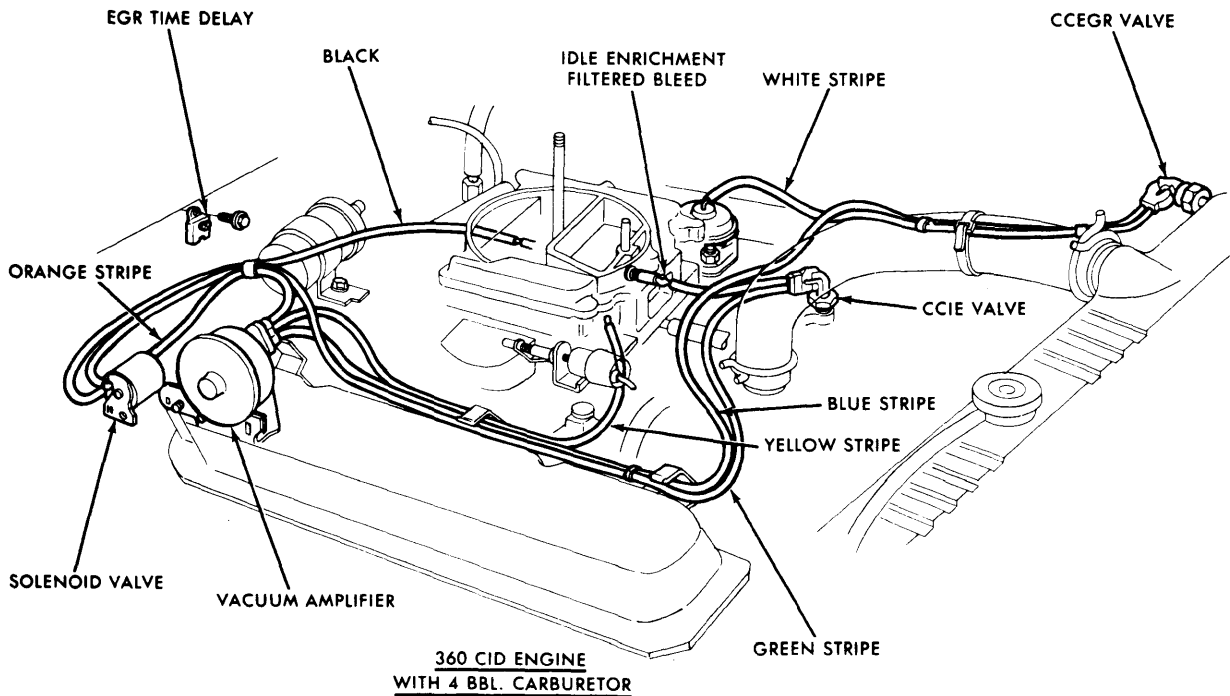

**360 CID ENGINE
WITH 4 BBL. CARBURETOR**

**EGR SYSTEM 360" HI-PERFORMANCE
(FEDERAL)**

1976 EXHAUST EMISSION SYSTEMS Chrysler Corp. Vacuum Diagrams (Cont.)

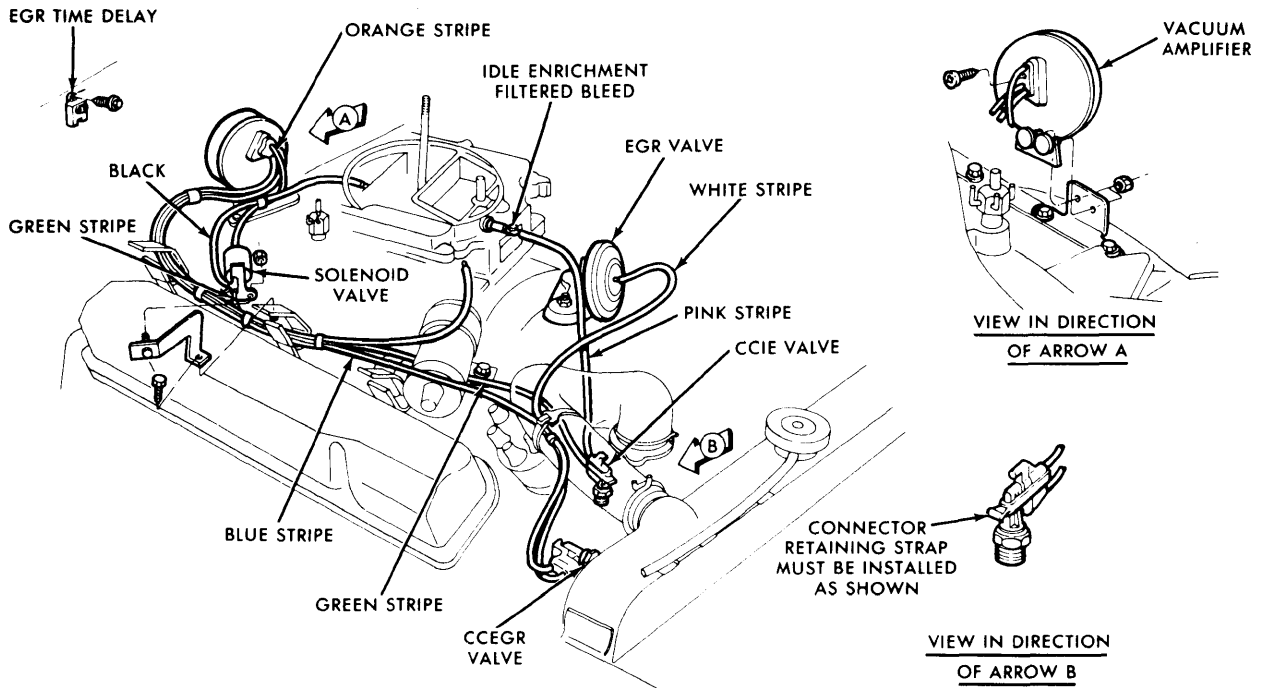
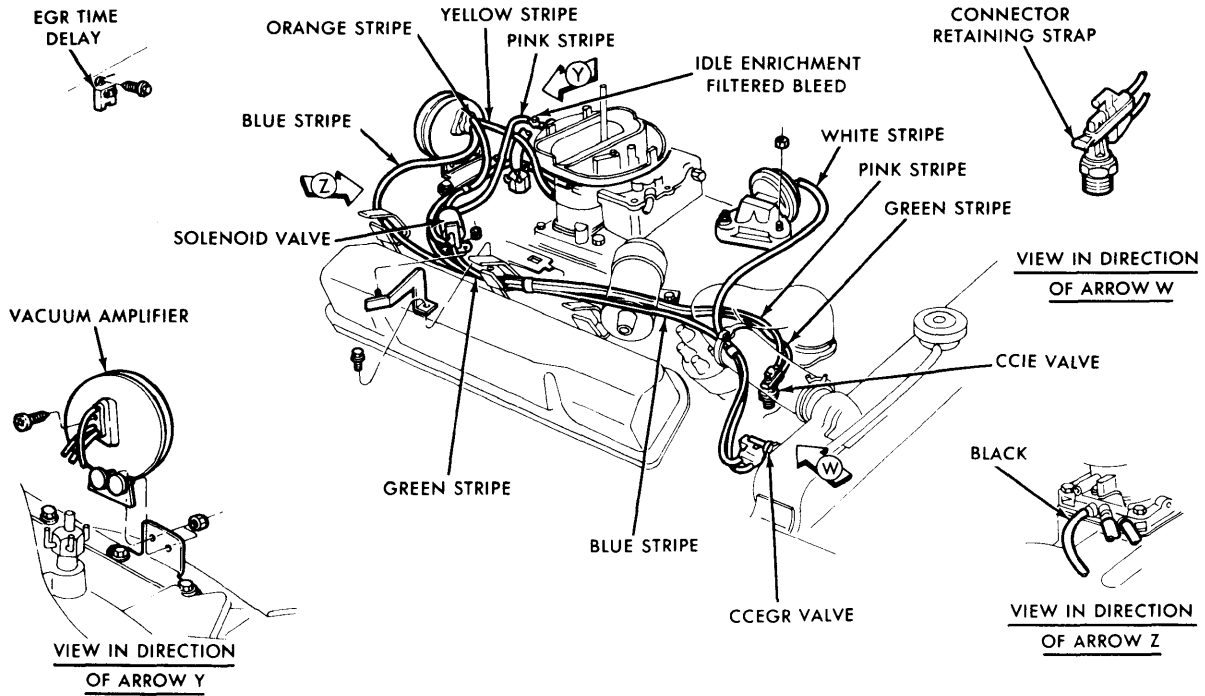

1976 EXHAUST EMISSION SYSTEMS Chrysler Corp. Vacuum Diagrams (Cont.)

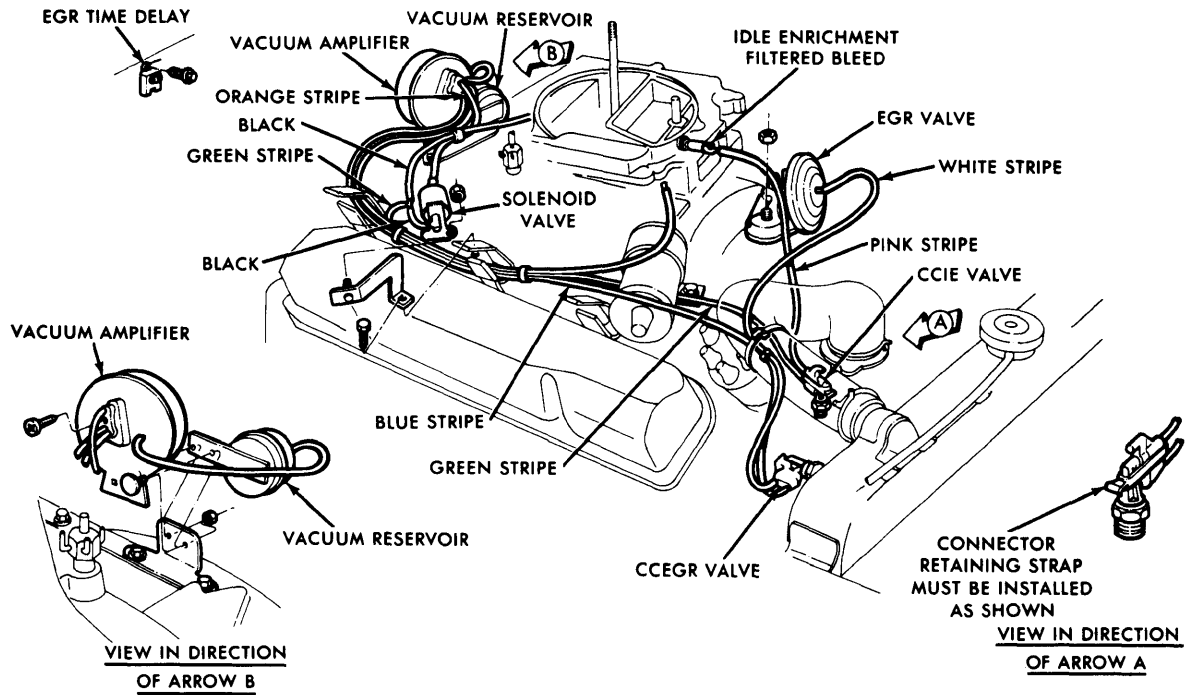

**EGR SYSTEM 400" & 440"
(CALIFORNIA)**