

318" & 360" V8 ENGINES

IDENTIFICATION CODING

ENGINE IDENTIFICATION

Engine identification number is stamped on left front of block below cylinder head. First two digits are year and manufacturing plant code. Next three digits are cubic inch displacement. Four following numbers are build date and the last four digits are engine sequence numbers.

Application	Digits
318"	318
360"	360

SPECIAL ENGINE MARKS

Information identifying special engine marks is stamped on the cylinder block after the serial number and is decoded as follows:

"M" or "R" – Followed by number, indicates which main or rod bearing journal is .001" undersize. This mark will be stamped on No. 8 crankshaft counterweight on 318" engines and on No. 3 counterweight on 360" engines.

"MX" or "RX" – Indicates **ALL** main or rod bearing journals .010" undersized. Marked on counterweight.

"A" – Indicates .020" oversize cylinder bores.

"♦" – Indicates .008" oversize lifters.

"X" – Indicates .005" oversize valve stems.

ENGINE REMOVAL

See *Engine Removal at end of Engine Section.*

CYLINDER HEAD & MANIFOLDS

INTAKE MANIFOLD

Removal – Remove air cleaner and disconnect fuel line. Disconnect accelerator linkage, heater hose, by-pass hose and radiator hose. Disconnect coil wires and vacuum hose between carburetor and distributor. Remove intake manifold, coil and carburetor as an assembly.

Installation – 1) Place a drop of suitable sealer into each corner between the cylinder head gasket tabs. Coat intake manifold side gaskets with sealer (318" only).

NOTE – On 360 engines, **DO NOT** use sealer on side composition gaskets.

2) Position intake manifold on engine. Inspect seals for correct positioning and install attaching bolts finger tight. Tighten cap screws in two steps, first tightening to 25 ft. lbs., then retightening to 40 ft. lbs. in sequence shown in Fig. 1.

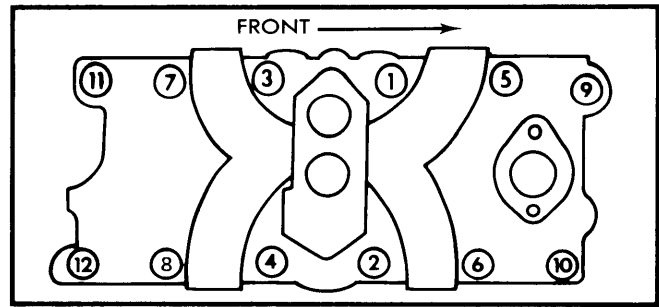

Fig. 1 Intake Manifold Tightening Sequence

CYLINDER HEAD

Removal – 1) Drain cooling system and disconnect battery ground cable. Remove alternator, air cleaner, distributor wires and cap. Disconnect fuel line, accelerator linkage, vacuum control hose between carburetor and distributor, coil wires, and temperature sending unit wire. Disconnect heater hoses, by-pass hose and radiator hose.

2) Remove closed ventilation system, evaporation control system and rocker arm covers. Remove water by-pass tube between intake manifold and water pump (if equipped). Remove intake manifold, coil and carburetor as an assembly. Remove exhaust manifolds from cylinder heads.

3) Remove rocker arm shaft assemblies, then pull push rods from cylinder heads after identifying location for reinstallation in original positions. Remove attaching bolts and cylinder heads from engine.

Installation – Clean all gasket surfaces of cylinder block and head. Coat new gasket with suitable sealer. Install gasket and cylinder head on block. Apply sealer to cylinder head bolts, install bolts and tighten to specifications in 2 steps. Use tightening sequence shown in Fig. 2.

Tightening Specifications

Application	Step 1 (Ft. Lbs.)	Step 2 (Ft. Lbs.)
All Models	50	95

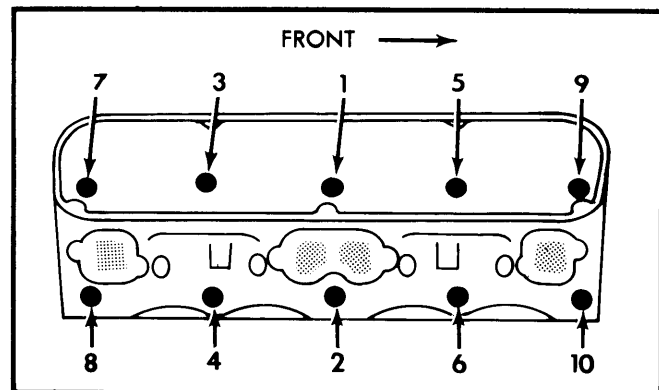

Fig. 2 Cylinder Head Tightening Sequence

318" & 360" V8 ENGINES (Cont.)

VALVES

VALVE ARRANGEMENT

E-I-I-E-E-I-I-E (Both banks, front to rear).

VALVE GUIDE SERVICING

Wear Check — Remove valve springs and install a locking sleeve over valve stem and install valve in cylinder head. Attach a dial indicator to cylinder head and position indicator at right angle to valve stem being measured. Total sideplay should not exceed .017". If dial indicator reading is excessive or stems are scuffed or scored, ream guides to correct size for installation of valves with oversize stems.

Servicing — Ream guides to next oversize valve stem if necessary. Oversize valve stems are available in .005", .015" and .030" oversize.

NOTE — Do not attempt to ream guides from standard diameter to .030" oversize in one step. Use step procedure to obtain .030".

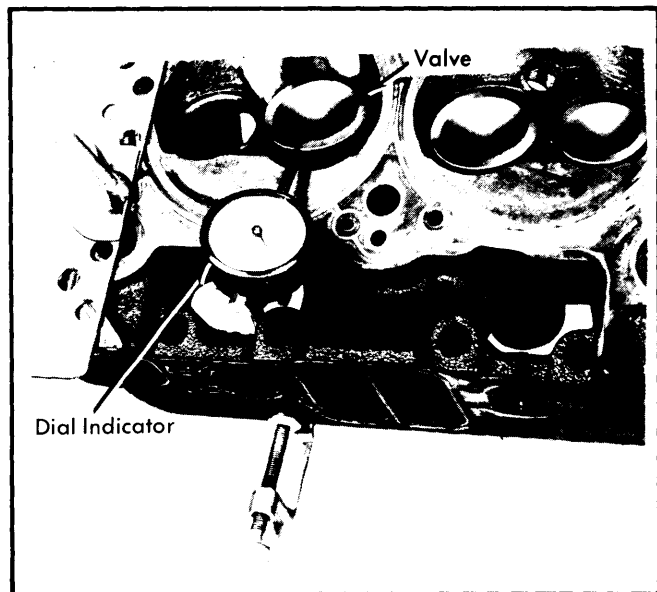

Fig. 3 Measuring Valve Stem to Guide Clearance

VALVE STEM OIL SEALS

Cup type seal is used on all valves. Long seal is used on intake valve and short seal is used on exhaust valve. If seals are removed for any reason, new seals must be used upon assembly.

VALVE SPRINGS

Removal — With cylinder head removed, compress valve springs using valve spring compressor. Remove valve retaining locks, valve spring retainers, rotators (if equipped), valve springs and valve stem cup seals.

NOTE — Remove any burrs from valve stem lock grooves to prevent damage to valve guide if valves are removed.

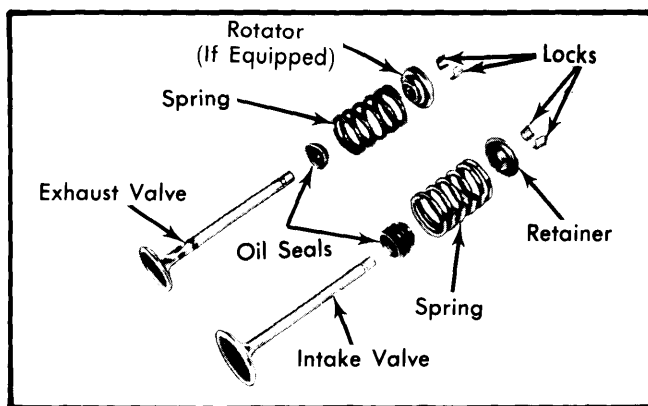

Fig. 4 Exploded View of Valve Assemblies

Inspection — Whenever valve springs have been removed, they must be tested. Using a suitable tester, valve springs must be within specifications. Replace springs which do not meet specifications. Inspect each valve spring for squareness using a steel square and surface plate. If spring is more than 5/64" out-of-square, a new spring must be installed.

Installation — 1) Coat valve stems with lubricant and position in cylinder head. If valve or seats have been reground, check valve stem height using gauge C-3968. If valve is too long, grind material off valve stem tip until length is within limits.

NOTE — If engine is equipped with rotators, do not grind valve stems.

2) Install new oil seals on all valves, reinstall valve springs and retainers. Use spring compressor to compress springs, then install valve locks.

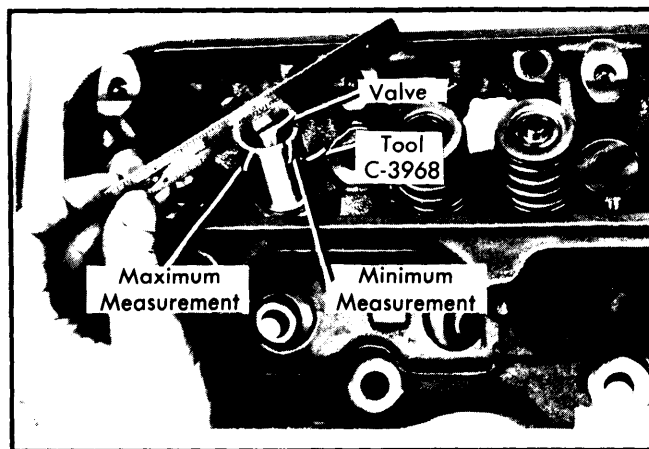

Fig. 5 Measuring Valve Stem Length

VALVE SPRING INSTALLED HEIGHT

1) If valves and/or seats are reground, measure installed height of springs. Measurement is taken from bottom of spring seat in cylinder head to bottom surface of spring retainer.

318" & 360" V8 ENGINES (Cont.)

NOTE — If spacers are installed, measure from top of spacer.

2) If installed height is not within specifications, install a 1/16" spacer at head counterbore to correct spring height.

CAUTION — Do not shim to a height less than specifications.

Valve Spring Installed Height

Application	Height
All W/O Rotators	1 5/8 - 1 11/16"
All W/Rotators	1 29/64 - 1 33/64"

ROCKER ARM ASSEMBLY

1) Rocker arms are stamped steel type; arms are mounted on shaft attached to cylinder head at five support brackets which are cast into cylinder head. Rocker arms have right and left positions (See Fig. 6). If rocker arm assemblies were disassembled, reassemble with rocker arms in correct position on shaft. (See Fig. 7).

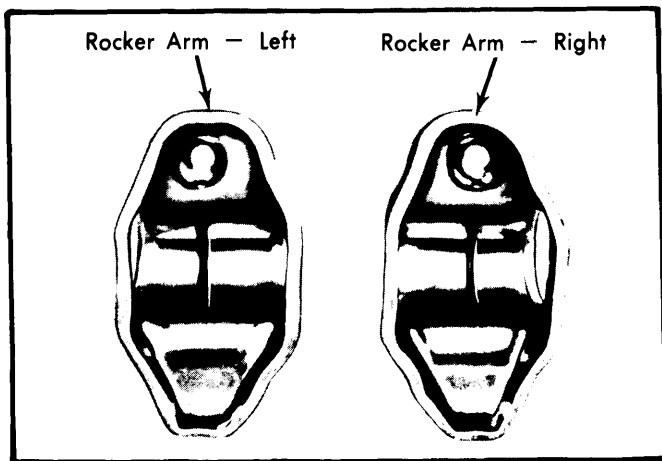

Fig. 6 Rocker Arm Identification

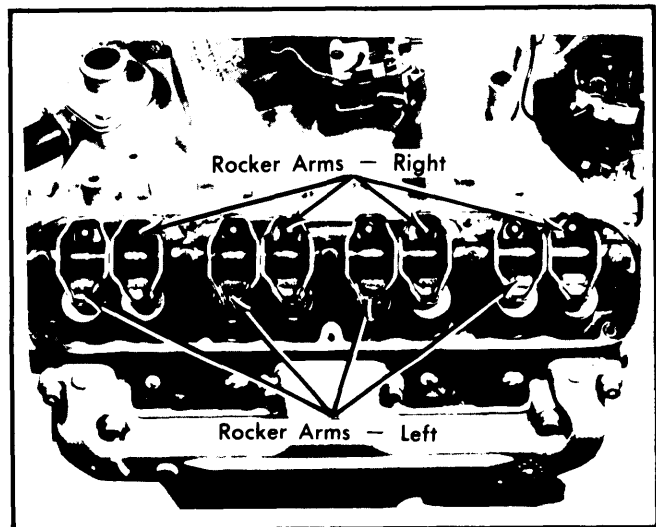

Fig. 7 Rocker Arm Location on Rocker Arm Shaft

2) Install rocker arms and shaft to engine while noting the following: Notch on end of rocker arm shaft must point to centerline of engine and toward engine front on left hand bank, or to rear of engine on right hand bank. Long, stamped retainers must be in number two and four positions.

HYDRAULIC VALVE LIFTER ASSEMBLY

NOTE — Lifters are serviced as complete assemblies only. Parts are not interchangeable between lifters. If any component of lifter is worn or damaged, complete lifter must be replaced.

To test, remove cap from plunger (see Fig. 8) and plunger from lifter body. Fill lifter body with clean kerosene and install plunger and cap. Place lifter upright in Lifter Testing Tool (C-4343), and check leak down. If lifter collapses immediately, disassemble, clean and retest. If rapid leak down still occurs, replace lifters. Use straightedge to check all lifters for a negative crown. If a negative crown (dish) is observed, lifter must be replaced.

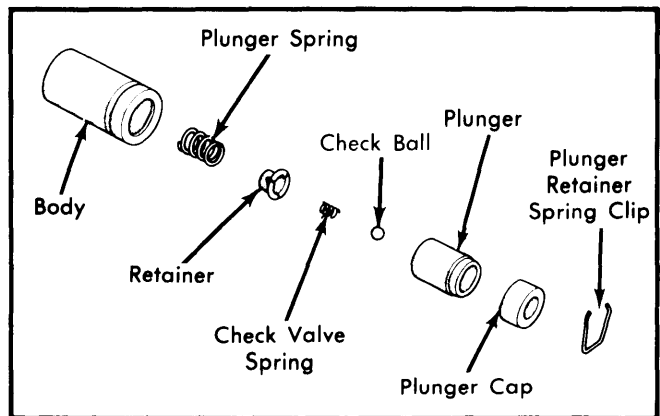

Fig. 8 Exploded View of Hydraulic Lifter Assembly

PISTONS, PINS & RINGS

OIL PAN

See Oil Pan Removal at end of Engine Section.

PISTON & ROD ASSEMBLY

NOTE — Following procedures are with cylinder head and oil pan removed.

Removal — 1) Remove ridge at top of cylinder bores using suitable tool before removing pistons from block.

NOTE — Keep tops of pistons covered during this procedure.

2) Rotate crankshaft and inspect connecting rods and rod caps for cylinder identification. Identify them if necessary. Remove rod cap and push each piston and rod assembly out top of cylinder bore being careful not to nick crankshaft journals. Install rod caps on mating rods.

318" & 360" V8 ENGINES (Cont.)

Installation – 1) Before installing piston and connecting rod assemblies into cylinder block, compression ring gaps must be staggered so neither is in line with oil ring rail gaps and "TOP" must be facing top of piston. Oil ring expander ends should be positioned under the notch on piston. Oil ring rail gaps should be facing middle of engine upon installation and spread 3" apart. See Fig. 9.

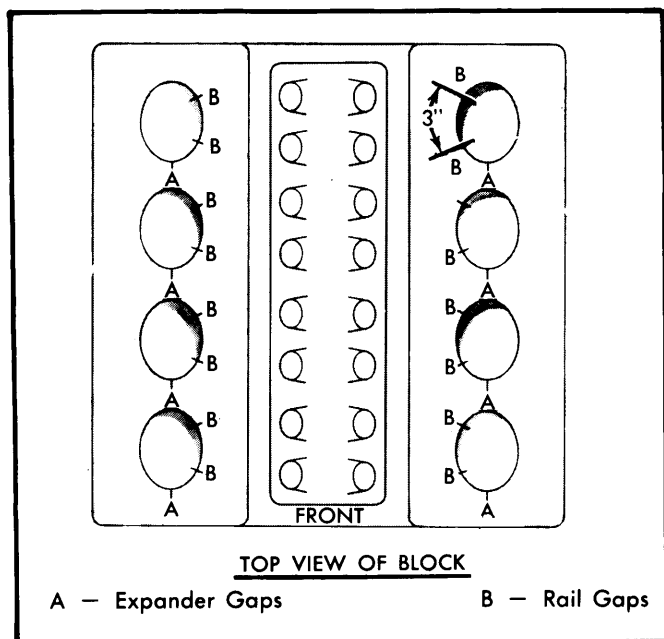

Fig. 9 Positioning Oil Rings for Installation

2) Immerse piston head and rings in clean engine oil and slide suitable ring compressor over piston and tighten.

NOTE – Do not allow position of rings to change during ring compressor installation and tightening.

3) Install connecting rod bolt protectors on rod bolts. The long protector should be installed on the numbered side of the connecting rod.

4) Rotate crankshaft so connecting rod journal is in center of cylinder bore. Insert rod and piston assembly into cylinder bore and guide rod over the crankshaft journal, taking care not to nick the journal.

NOTE – Notch on top of piston must face front of engine and larger chamfer of connecting rod bore must be installed toward crankshaft journal fillet.

5) Tap piston into cylinder bore using wooden handle of a hammer and guide connecting rod into place on crankshaft journal. Install rod cap and tighten. Repeat procedure for each remaining piston assembly.

FITTING PISTONS

Pistons should be measured 90° to piston pin axis at top of skirt. Measure cylinder bore halfway down the bore 90° to crankshaft center line. Pistons and cylinder bores should be measured at normal room temperature, 70°F.

PISTON PINS

Removal – Use suitable tool for piston pin removal as follows: Install pilot on main screw (see Fig. 10) and install screw through piston pin. Install anvil (with spring removed) over threaded end of main screw with small end of anvil against piston boss. Install nut loosely on main screw and place assembly on a press. Press piston pin out of connecting rod. Remove tool from piston.

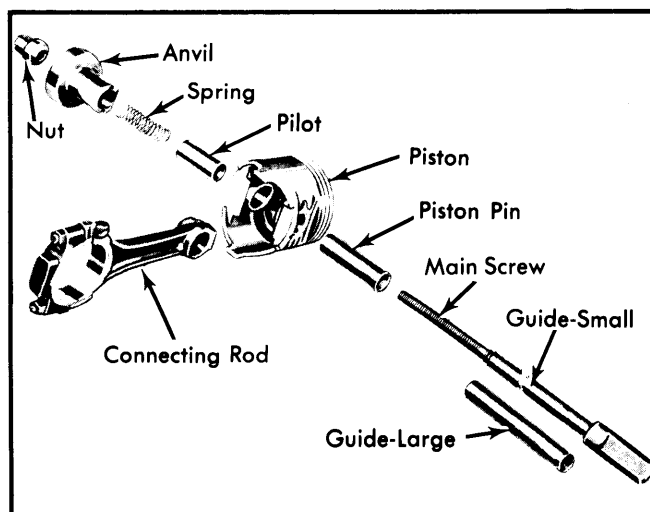

Fig. 10 Exploded View of Piston Pin Removal & Installation Tool

Installation – 1) Lubricate piston pin holes in piston and connecting rod and use suitable tool to install pin. Install tool spring inside pilot and install spring and pilot in the anvil. Install piston pin over main screw.

2) Place piston (with notch up) and connecting rod over pilot so pilot extends through piston pin holes. Assemble rods to pistons of the right cylinder bank (2,4,6 and 8) with indent on piston head opposite to larger chamfer on large bore end of connecting rod. Assemble rods to pistons of the left cylinder bank (1,3,5 and 7) with indent on piston head on the same side as the large chamfer on large bore end of connecting rod.

3) Install main screw and piston pin in piston and install nut on main screw to hold assembly together. Place assembly in a vise. Press piston pin in until piston pin bottoms on the pilot.

Checking Pin Fit – Assemble suitable tool in same manner as for piston pin removal and place assembly in a vise. Attach a torque wrench to nut and test torque to 15 ft. lbs. If connecting rod moves downward on piston pin, reject connecting rod and piston pin combination. Install a new connecting rod and recheck. If connecting rod does not move under 15 ft. lbs. torque, piston pin fit is satisfactory.

CRANKSHAFT & ROD BEARINGS

MAIN & CONNECTING ROD BEARINGS

NOTE – Plastigage method is used for checking bearing clearances. The following procedures are with oil pan and oil pump removed.

318" & 360" V8 ENGINES (Cont.)

Connecting Rod Bearings — 1) After ensuring rod caps are marked for cylinder identification, remove rod caps. Turn crankshaft until connecting rod to be checked starts moving toward the top of the engine. Place Plastigage across width of bearing shell in cap approximately $\frac{1}{4}$ " off center and away from oil holes. Tighten bearing cap. Remove bearing cap and compare width of flattened Plastigage with inch scale on package. Difference in readings between the ends indicates amount of taper present. Compare readings with specifications.

2) New bearings are available in standard, .001", .002", .003", .010" and .012" undersize. Always install bearings in pairs. Do not use a new bearing with an old bearing. Install connecting rod bearings so formed tang fits into machined groove in connecting rod. Install rod caps, with "V" groove of bearing matching "V" groove of cap, and tighten nuts.

Main Bearings — 1) The total clearance of the main bearings can only be determined by removing the weight of the crankshaft. Place a .010" cardboard shim between the bearing shell and the bearing cap of the bearings adjacent to the bearing being checked. Tighten caps to 10-15 ft. lbs., then measure clearance as explained under Connecting Rod Bearings.

2) New bearings are available in standard, .001", .002", .003", .010" and .012" undersize. A new .001" bearing may be used in combination with a new standard bearing or a .002" with a .001".

NOTE — Always use smaller diameter bearing as upper bearing on journal.

3) If bearing clearances are not within limits, remove bearing cap, insert suitable tool (C-3509) in oil hole journal and rotate crankshaft clockwise to remove upper bearing. To install new upper bearing, slightly chamfer sharp edges from plain side and start bearing in place. Insert tool and slowly rotate crankshaft counterclockwise, sliding bearing in place. Install main bearing cap with new bearing installed and tighten.

NOTE — Upper main bearings are grooved and lower main bearings are plain. Upper and lower are not interchangeable.

4) Check crankshaft end play and if not within specifications, change number 3 main bearing. This bearing carries thrust load.

REAR MAIN BEARING OIL SEAL

New split rubber type seals may be used for replacement without removing crankshaft. New type must be installed as paired upper and lower seals and cannot be used or combined with old type rope seals.

Removal W/Crankshaft Installed — With oil pan removed, remove rear seal retainer and rear main bearing cap. Remove upper seal by turning suitable tool (C-4148) into end of seal and pulling seal out with tool (do not mar crankshaft). Remove lower seal by prying carefully from the side with small screwdriver.

Installation — 1) On 318" engines, insert cap seals into slots in bearing cap. Seal with yellow paint goes in right side of cap with cap in engine position. Make sure seals are installed with narrow sealing edges up. Also make sure that edge of cap

seals line up exactly with shoulder in bearing cap or seals will leak. Install seal edge toward inside of shoulder and pull outward on small end of seal until edges line up with shoulder.

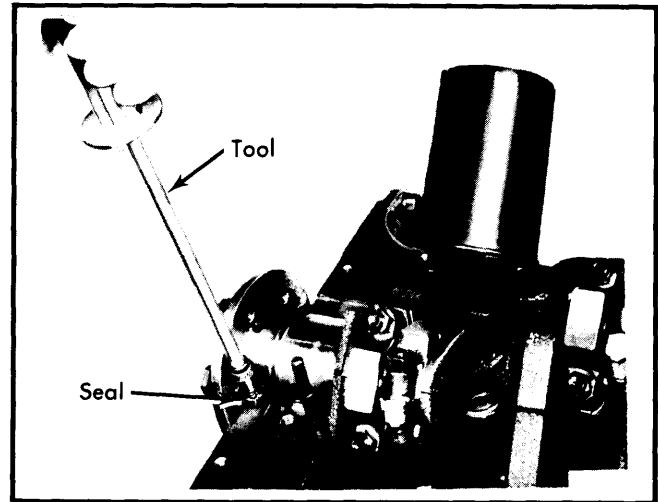

Fig. 11 Removing Upper Rear Main Oil Seal

2) On all models, lightly oil sealing lips of crankshaft seals. Rotate upper seal into block, making sure paint stripe is to rear. Care must be taken not to cut or shave seal outer surface. Place lower seal half in bearing cap, making sure paint stripe is to rear. On 360" engines, apply sealer on cap surface next to rear main seal. On all models, install cap and tighten bolts to 85 ft. lbs.

CAMSHAFT

ENGINE FRONT COVER

Removal — 1) Drain cooling system and remove radiator and water pump assembly. Remove power steering pump (if equipped). Remove pulley from vibration damper. Remove bolt and washer securing vibration damper on crankshaft. Using suitable tool (C-3688), remove damper from end of crankshaft.

2) Remove fuel lines and fuel pump. Loosen oil pan bolts and remove front bolt at each side. Remove cover attaching bolts, cover and gasket using care not to damage oil pan gasket.

NOTE — It is normal to find neoprene particles collected between crankshaft seal retainer and oil slinger.

Installation — Check that mating surfaces of cover and cylinder block are clean and free from burrs. Lubricate seal lip with Lubriplate and install cover with new gasket. Install attaching bolts and tighten. Tighten oil pan bolts and install fuel pump, lines and power steering pump. Install vibration damper, water pump assembly and radiator. Fill cooling system and adjust drive belt tension.

FRONT COVER OIL SEAL

Removal — Remove belts from pulleys and remove fan and shroud from engine. Remove crankshaft pulley and vibration damper. Use suitable tool behind seal lips, pry outward being careful not to damage crankshaft seal surface of cover.

318" & 360" V8 ENGINES (Cont.)

Installation — Install new seal by using seal installing tool C-4251 (or equivalent). Install threaded shaft part of tool into threads of crankshaft. Place seal into opening with springs towards inside of engine. Place adapter with thrust bearing and nut on shaft. Tighten nut until tool is flush with cover. Reinstall vibration damper, crankshaft pulley, fan, shroud and belts.

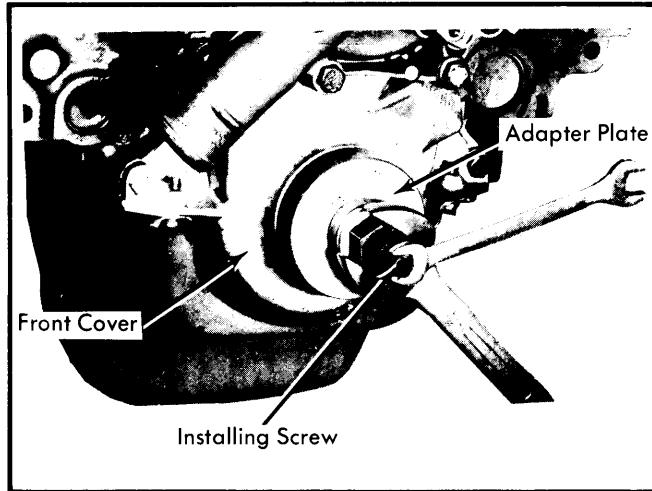

Fig. 12 Installing Front Cover Seal

TIMING CHAIN

Checking For Stretch — 1) Position scale next to timing chain to measure any movement of chain, See Fig. 13. Place torque wrench with socket over camshaft sprocket lock bolt and apply torque in direction of crankshaft rotation to remove slack. Torque should be 30 ft. lbs. with cylinder heads installed or 15 ft. lbs. with cylinder heads removed.

NOTE — Do not permit crankshaft to move.

2) Apply same torque in reverse direction and measure amount of chain movement. If movement exceeds $\frac{1}{8}$ ", install new timing chain.

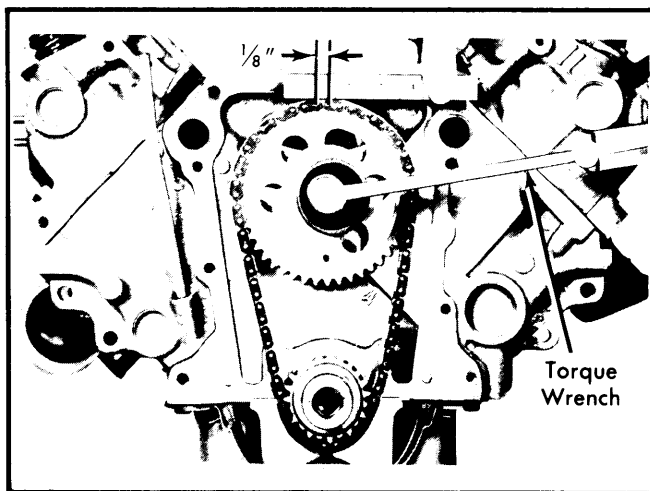

Fig. 13 Measuring Timing Chain Stretch

Removal — With front cover removed, remove camshaft sprocket attaching bolt, washer and fuel pump eccentric. Remove timing chain with crankshaft and camshaft sprockets.

Installation — 1) When installing timing chain, use a suitable tool (C-3509) to prevent camshaft from contacting welch plug in rear of engine block. Remove distributor and oil pump distributor drive gear. Locate tool against rear side of cam gear and attach tool with distributor retainer plate bolt. Proceed as follows:

2) Place camshaft and crankshaft sprockets on bench with timing marks on an imaginary centerline through bore of both sprockets. Place timing chain around both sprockets. Turn crankshaft and camshaft to line up with keyway location in sprockets.

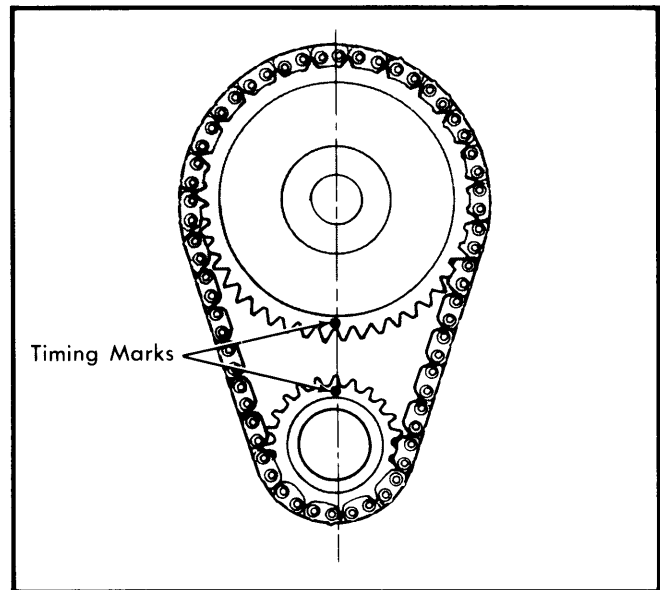

Fig. 14 Timing Chain Sprocket Alignment Marks

3) Slide both sprockets evenly over their respective shafts (with new chain installed on sprockets). Use a straightedge to measure alignment of timing marks. Install fuel pump eccentric, cup washer and camshaft bolt. Tighten bolt and check camshaft end thrust. Slide crankshaft oil slinger over shaft and up against sprocket (flange away from sprocket). Install front cover.

CAMSHAFT

NOTE — Whenever a new camshaft is installed; inspect and check, with a straightedge, all tappet faces for "dishing". Replace any tappet with a negative crown.

Removal — 1) With engine removed from vehicle, remove intake manifold, front cover and timing chain. Remove rocker arm and shaft assemblies. Remove push rods and tappets.

NOTE — Identify push rods and tappets for reinstallation in original location.

318" & 360" V8 ENGINES (Cont.)

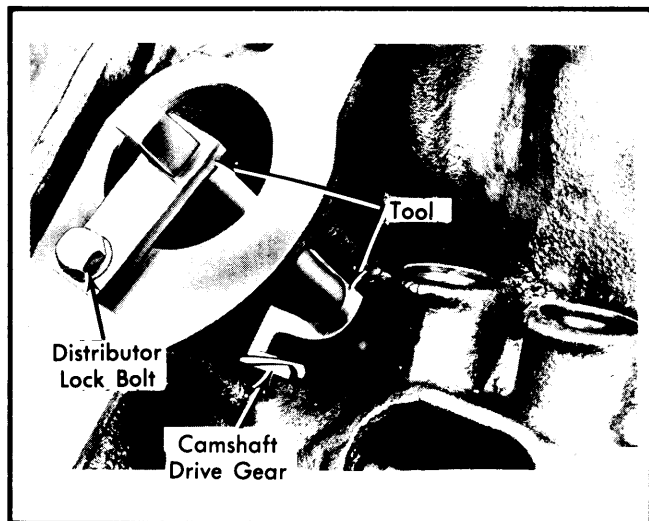

Fig. 15 Camshaft Holding Tool (C-3509) Installed

2) Remove distributor and lift out distributor drive shaft. Remove camshaft thrust plate and note location of oil tab. Install a long bolt into front of camshaft to facilitate removal, and carefully remove camshaft.

Installation — 1) Lubricate camshaft lobes and bearing journals. Insert camshaft to within 2" of its final position in block. Install camshaft holding tool C-3509 in distributor drive hole and hold in position using distributor retainer plate bolt.

NOTE — Tool should remain in position until sprockets and timing chain are installed.

2) Install camshaft to final position. Install thrust plate and chain oil tab. Install remaining components in reverse order of removal. See *Distributor Timing and Installation*.

CAUTION — Top edge of tab should be flat against thrust plate to provide oil for chain lubrication.

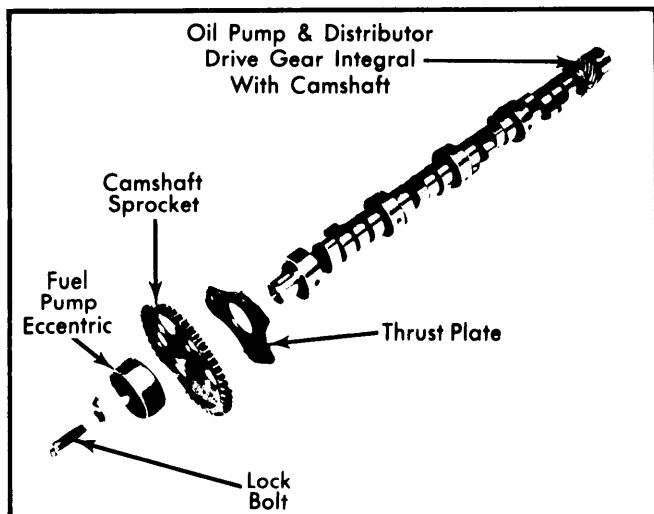

Fig. 16 Exploded View of Camshaft Assembly

CAMSHAFT BEARINGS

Removal — With engine completely disassembled, drive out rear cam bearing welch plug. Install proper size adapters and horseshoe washers (C-3132A) at rear of each bearing to be removed and drive out bearings.

Installation — Slide new rear bearing over proper adapter of suitable tool, install horseshoe lock and carefully drive bearing into place. Install remaining bearings in same manner while noting the following: Bearings must be aligned to bring oil holes in line with oil passages from main bearing. Number two bearing must index with oil passage to left cylinder head and number four bearing must index with oil passage to right cylinder head. Install a new welch plug at rear of camshaft.

CAUTION — Welch plug must not leak.

CAMSHAFT END THRUST

End thrust is taken by thrust plate behind camshaft sprocket. End play should be .002-.010". If not within specifications, replace thrust plate.

DISTRIBUTOR TIMING & INSTALLATION

Distributor Timing — Before installing distributor-oil pump drive shaft, time engine as follows: Rotate crankshaft so number one cylinder is at top dead center on firing stroke. Straight line on vibration damper should be under "O" on timing indicator. Coat shaft and drive gear with engine oil. Install shaft so that when gear spirals into place, it will index with oil pump shaft, so slot in top of drive gear will point in a direction parallel to the centerline of the crankshaft.

Distributor Installation — Hold distributor over mounting pad of cylinder block with vacuum chamber pointing toward right of engine. Turn rotor to point forward and approximately toward location of number one terminal in distributor cap. Place distributor gasket in position, lower distributor and engage shaft in slot of distributor drive shaft gear. Turn distributor clockwise until breaker points are just separating and install hold down clamp.

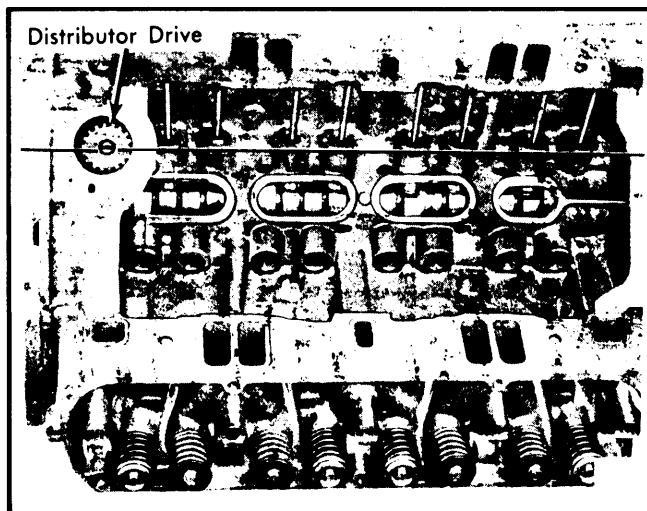

Fig. 17 Alignment of Distributor Gear with Engine for Distributor Timing

318" & 360" V8 ENGINES (Cont.)

ENGINE OILING

Crankcase Capacity — Capacity of all engines is 5 quarts. On all engines, add 1 quart with filter change.

Oil Filter — Change at first oil change and every second oil change after that.

Pressure Regulator Valve — In oil pump. Not adjustable.

Normal Oil Pressure (Hot)

Application	PSI @ RPM
All Engines.....	30-80@2000

ENGINE OILING SYSTEM

System has a rotor type oil pump and full flow type oil filter. Oil is forced by the pump through a series of oil passages in engine to provide lubrication to engine components. Oil is supplied to hollow rocker arm shaft (left side) from No. 2 camshaft bearing and to hollow rocker arm shaft (right side) from No. 4 camshaft bearing through indexed holes in camshaft. Oil enters rocker arm shaft through second rocker arm bracket from front (left side) and second bracket from rear (right side) to lubricate rocker arm assembly. Valve assembly is lubricated by oil spray from drilled holes in rocker arms.

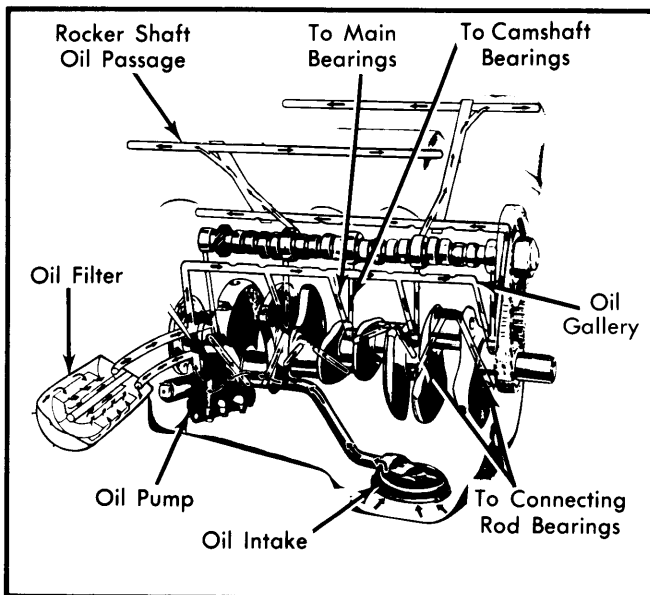

Fig. 18 Chrysler Corp. 318" & 360" Engine Oiling System

OIL PUMP

Disassemble, clean and inspect all parts for proper clearances. See *Oil Pump Specifications*.

NOTE — Inner rotor and shaft assembly can only be replaced if outer rotor is replaced, as units are a matched assembly. See Fig. 19.

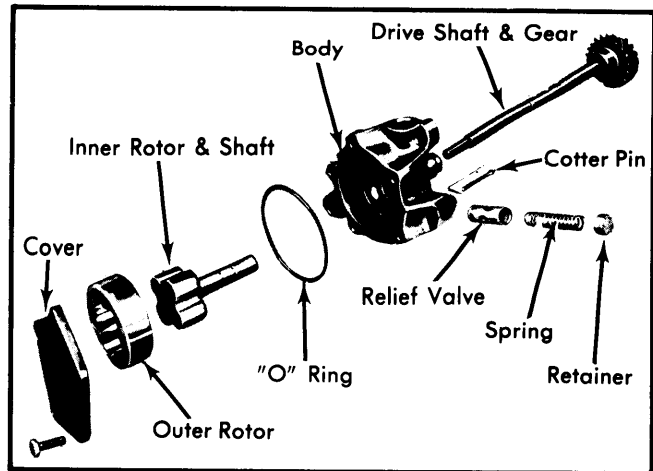

Fig. 19 Exploded View of Oil Pump Assembly

Oil Pump Specifications

Application	Specifications
Clearance Over Rotors0015" Max.
Inner & Outer Rotor Thickness	
318" Engine825" Min.
360" Engine943" Min.
Outer Rotor Diameter	2.469" Min.
Outer Rotor-to-Pump Body014" Max.
Rotor Tip Clearance010"

Pressure Relief Valve Spring — Spring has a free length of 2¹/₃₂-2³/₆₄". Spring should test 16.2-17.2 lbs. when compressed to 1¹¹/₃₂". Replace springs which do not meet specifications.

TIGHTENING SPECIFICATIONS

Application	Ft. Lbs.
Camshaft Sprocket Bolt	50
Camshaft Thrust Plate	18
Front Cover Bolt	35
Connecting Rod Nut	45
Crankshaft Damper Bolt	100
Cylinder Head Bolt	105
Exhaust Manifold	
Screw	20
Nut	15
Flywheel-to-Crankshaft	55
Intake Manifold Bolt	40
Main Bearing Cap Bolt	85
Oil Pan	
Screw	17
Bolt	20
Oil Pump Attaching Bolt	30
Rocker Arm Shaft Retaining Bolt	17

Chrysler Corp. V8 Engines

318" & 360" V8 ENGINES (Cont.)

ENGINE SPECIFICATIONS

GENERAL SPECIFICATIONS							
Year	Displ. Cu. Ins.	Carburetor	HP at RPM	Torque (Ft. Lbs. at RPM)	Compr. Ratio	Bore	Stroke
1980	318"	2-Bbl. & 4-Bbl.	8.7:1	3.91"	3.31"
	360"	2-Bbl. & 4-Bbl.	8.6:1	4.00"	3.58"

VALVES							
Engine & Valve	Head Diam.	Face Angle	Seat Angle	Seat Width	Stem Diameter	Stem Clearance	Valve Lift
318" Int.	1.780"	45°	45°	.065-.085"	.372-.373"	.001-.003"	.373"
	1.500"	45°	45°	.080-.100"	.371-.372"	.002-.004"	.400"
360" Int.	1.880"	45°	45°	.065-.085"	.372-.373"	.001-.003"	.410"
	1.600"	45°	45°	.080-.100"	.371-.372"	.002-.004"	.410"

PISTONS, PINS, RINGS						
Engine	PISTONS	PINS		RINGS		
	Clearance	Piston Fit	① Rod Fit	Rings	End Gap	Side Clearance
318"	.0005-.0015"	.000-.0005"	.0007-.0014"	1 & 2 3	.010-.020" .015-.055"	.0015-.0030" .0002-.005"
360"	.0005-.0015"	.00025-.00075"	.0007-.0014"	1 & 2 3	.010-.020" .015-.055"	.0015-.0030" .0002-.005"

① — Press fit

CRANKSHAFT MAIN & CONNECTING ROD BEARINGS							
Engine	MAIN BEARINGS				CONNECTING ROD BEARINGS		
	Journal Diam.	Clearance	Thrust Bearing	Crankshaft End Play	Journal Diam.	Clearance	Side Play
318"	2.4995-2.5005"	.0005-.0020"	3	.002-.007"	2.124-2.125"	.0005-.0025"	.006-.014"
360"	2.8095-2.8105"	.0005-.0020"	3	.002-.009"	2.124-2.125"	.0005-.0025"	.006-.014"

VALVE SPRINGS			
Engine	Free Length	PRESSURE (LBS.)	
		Valve Closed	Valve Open
318",360" Int.	2.00"	78-88@1 ¹¹ / ₁₆ "	170-184@1 ⁵ / ₁₆ "
	1.81"	80-90@1 ³¹ / ₆₄ "	181-197@1 ¹ / ₁₆ "

CAMSHAFT			
Engine	Journal Diam.	Clearance	Lobe Lift
318"	No. 1	1.998-1.999"	.001-.003"
	No. 2	1.982-1.983"	
	No. 3	1.967-1.968"	
	No. 4	1.951-1.952"	
	No. 5	1.5605-1.5615	
360"	No. 1	1.998-1.999"	.001-.003"
	No. 2	1.982-1.983"	
	No. 3	1.967-1.968"	
	No. 4	1.951-1.952"	
	No. 5	1.5605-1.5615"	