

460" V8 ENGINE

IDENTIFICATION CODING

ENGINE IDENTIFICATION

Rating plate carries information covering vehicle model, series, point of manufacture, and unit number. Plate is located on cowl surface under the hood. Number code is as follows:

E15ADC50000

- First Digit** – Truck Series Letter.
- Second & Third Digits** – Truck Series Number.
- Fourth Digit** – Engine Code.
- Fifth Digit** – Assembly Plant.
- Remaining Digits** – Consecutive Unit Number.

Engine Identification Codes

Application	Code Letter
Econoline Models	A
All Other Models	J

ENGINE REMOVAL

See *Engine Removal at end of ENGINE Section.*

CYLINDER HEAD & MANIFOLD

INTAKE MANIFOLD

Removal – 1) Drain cooling system. Remove air cleaner and duct assembly, disconnect radiator and heater hoses at intake manifold and water pump and position out of way.

2) Disconnect and tag all vacuum lines for proper installation. Remove distributor cap and spark plug wires as an assembly, remove distributor.

3) Disconnect accelerator linkage at carburetor and speed control linkage bracket, if equipped, and position linkage out of way. Disconnect fuel line at carburetor.

4) Disconnect any electrical wiring to intake manifold and position out of way. Remove coil and bracket assembly. Remove attaching bolts and nuts and remove intake manifold and carburetor as an assembly.

Installation – 1) Clean and inspect manifold for cracks, damaged gasket surfaces, or other defects. Thoroughly clean all gasket surfaces and apply an oil resistant sealer to intake manifold and block seal surfaces (4 corners).

2) Position front and rear seals on cylinder block and new gaskets on cylinder heads. Ensure that holes in gaskets are aligned with holes in cylinder heads. Position gaskets in slots with end tabs over ribs on seals.

3) Lower intake manifold on engine and check for correct positioning of gaskets and seals before installing attaching bolts and nuts. Install bolts and nuts, then tighten in sequence shown in Fig. 1.

4) To install remaining components, reverse removal procedure. After engine has been started and allowed to reach normal operating temperature, retighten manifold attaching bolts and nuts.

CYLINDER HEAD

Removal – 1) Drain cooling system. Remove intake manifold as previously outlined. Disconnect exhaust pipe from exhaust manifold and remove bolt attaching alternator bracket to cylinder head.

2) If equipped with air conditioning, shut off compressor at service valves and remove valves and hoses from compressor. Remove nuts attaching compressor support bracket to water pump and bolts attaching compressor to upper mounting bracket and position compressor out of way. Remove upper mounting bracket from cylinder head.

3) If not equipped with air conditioning, remove bolts attaching power steering reservoir bracket to cylinder head. Position reservoir and bracket out of way.

4) Remove rocker arm covers. Remove rocker arms and push rods in sequence so they can be installed in their original positions. Remove cylinder head attaching bolts and remove cylinder heads and exhaust manifold as assemblies.

Installation – Clean old gasket material from cylinder heads and block. Position head gaskets on block and install cylinder heads. Tighten all head bolts in sequence in three steps. See Fig. 2. To install remaining components, reverse removal procedure. Adjust valve clearance.

Cylinder Head Tightening Specifications

Steps	Ft. Lbs.
1.....	80
2.....	110
3.....	130-140

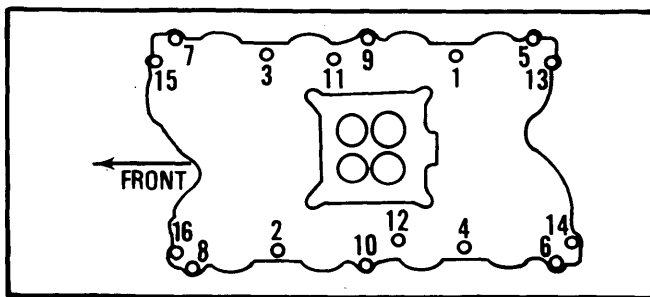

Fig. 1 Tightening Sequence for Intake Manifold

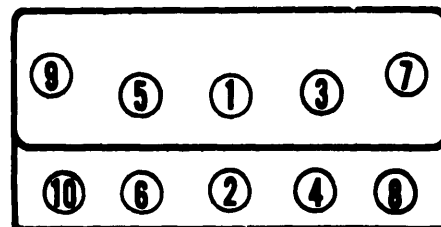

Fig. 2 Tightening Sequence for Cylinder Head

460" V8 ENGINE (Cont.)

VALVES

VALVE ARRANGEMENT

E-I-E-I-E-I-E-I (Left side, front to rear).
I-E-I-E-I-E-I-E (Right side, front to rear).

VALVE GUIDE SERVICING

To ream guides for installation of valves with oversize stems, always use reamers in sequence and always reface valve seats after valve guides are reamed. Reamers are available .003" oversize with standard size pilot; .015" oversize reamer with .003" oversize pilot; .030" oversize reamer with .015" oversize pilot.

VALVE STEM OIL SEALS

Umbrella type oil seals are used on all intake and exhaust valves. Install seals with cup side over valve guide.

VALVE SPRINGS

Removal — 1) Remove air cleaner and duct assembly. Remove rocker arm cover, spark plug, rocker arms and push rod from cylinder to be serviced.

2) Install air line with adapter into spark plug hole. Use spring compressing tool to compress valve spring and remove retainer lock.

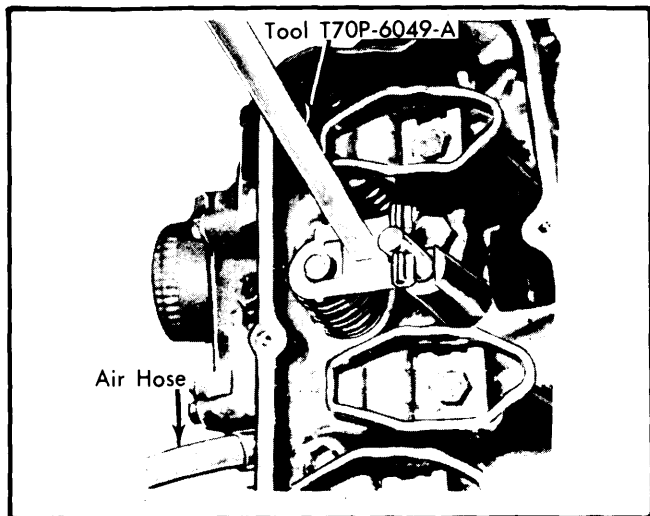

Fig. 3 Compressing Valve Spring for Removal

NOTE — If air pressure fails to hold valve closed, remove cylinder head and inspect valve seat area for damage. Remove and discard valve stem oil seal after removing spring retainer and valve spring.

CAUTION — Do not remove air pressure from cylinder as this will allow valve to drop into cylinder if piston has been forced to bottom of cylinder.

Installation — 1) Lubricate valve stem with engine oil and install new valve stem oil seal. Set spring and retainer over valve stem. Compress valve spring and install retainer locks.

2) Apply Lubriplate or equivalent to end of push rods and tip of valve stem. Install rocker arms and tighten bolts. To install remaining components, reverse removal procedure.

VALVE SPRING INSTALLED HEIGHT

Measure installed height of valve spring from surface of spring pad on cylinder head to underside of spring retainer. If installed height exceeds specifications, install spacer(s) below spring to reduce height to specified dimension. See Fig. 4.

CAUTION — Reducing installed height below specifications can cause spring breakage and rapid wear of cam lobe.

Valve Spring Installed Height Specifications Application	Installed Height
All Valves.....	1 ⁵ / ₁₆ - 1 ⁵³ / ₆₄ "

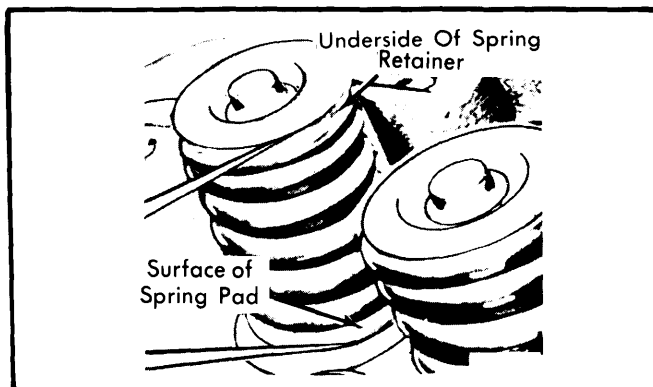

Fig. 4 Checking Valve Spring Installed Height

HYDRAULIC VALVE LIFTER ASSEMBLY

Lifters should be serviced as assemblies only as internal parts are matched sets and cannot be interchanged. If any part of lifter needs replacing, replace entire assembly. Leak down rate on lifters is 10-50 seconds at 1/16" plunger travel using suitable leak down tester. See Fig. 5.

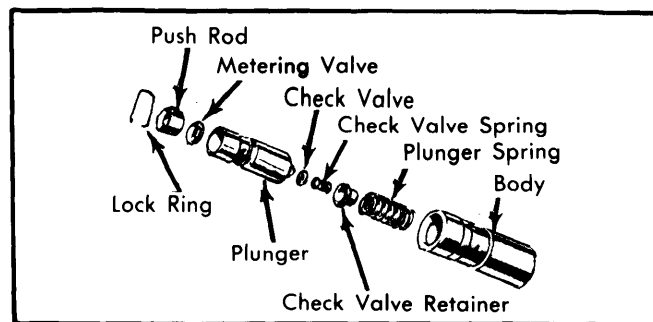

Fig. 5 Disassembled View of Hydraulic Valve Lifter

460" V8 ENGINE (Cont.)

ROCKER ARM ASSEMBLY

Rocker arms are individually mounted with fulcrum bolts which are threaded into cylinder head. Inspect rocker arms, fulcrum seats, oil deflectors and fulcrum bolts for undue or excessive wear. Replace all parts that show fatigue. Before installing, apply Lubriplate or equivalent to top of valve stem, rocker arm and fulcrum seat. See Fig. 6.

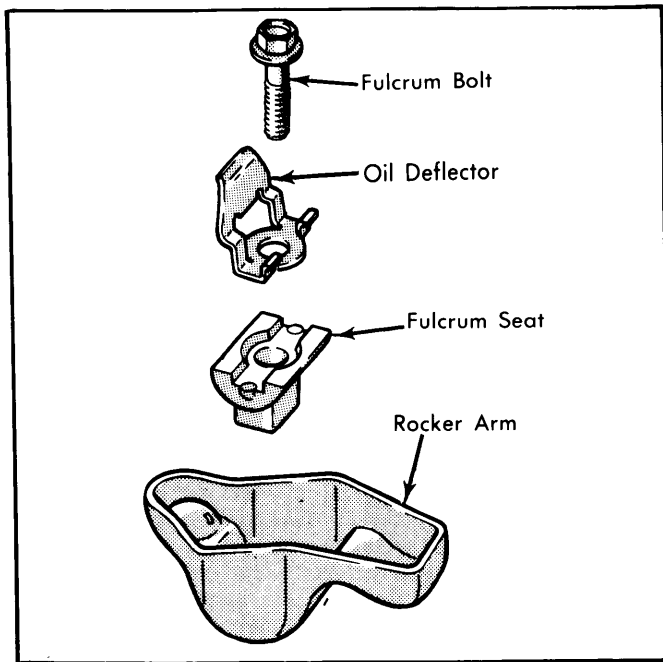

Fig. 6 Rocker Arm Assembly

HYDRAULIC VALVE LIFTER ADJUSTMENT

Repeated valve seat and face reconditioning will decrease valve stem to rocker arm clearance to point that if not compensated for, hydraulic valve lifters will cease to function. To compensate for dimensional changes in valve mechanism, a .060" shorter or .060" longer replacement push rod is available.

NOTE — Valve lifters must be completely collapsed when checking valve clearance.

1) Use suitable tool (T71P-6513-A or equivalent) to slowly collapse valve lifter until plunger is bottomed. Hold lifter down while checking valve clearance.

2) With No. 1 piston on TDC at end of compression stroke (position A in Fig. 7), set valve clearance on the following valves: No. 1 intake, No. 1 exhaust, No. 7 intake, No. 5 exhaust, No. 8 intake, No. 4 exhaust.

3) Rotate crankshaft to position B as shown in Fig. 7 and set valve clearance on the following valves: No. 4 intake, No. 2 exhaust, No. 5 intake, No. 6 exhaust.

4) Rotate crankshaft to position C as shown in Fig. 7 and set valve clearance on the following valves: No. 2 intake, No. 3 exhaust, No. 3 intake, No. 7 exhaust, No. 6 intake, No. 8 exhaust.

Collapsed Lifter Clearance

Application	Desired	Allowable
All100-.150"	.075-.175"

PISTON, PINS & RINGS

OIL PAN

See *Oil Pan Removal* at end of ENGINE Section.

PISTON & ROD ASSEMBLY

Removal — 1) With cylinder heads and oil pan removed, use ridge cutter to remove any ridge or deposits from upper end of cylinder bores.

NOTE — Piston must be at bottom of stroke. Cover piston with cloth to collect cuttings.

With No. 1 At TDC At End Of Compression Stroke, Make Chalk Mark At Points B & C Approximately 90° Apart.

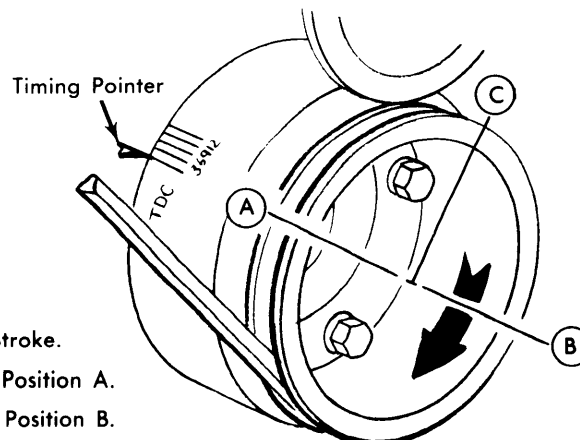

Position A — No. 1 At TDC At End Of Compression Stroke.

Position B — Rotate Crankshaft 180° Clockwise From Position A.

Position C — Rotate Crankshaft 270° Clockwise From Position B.

Fig. 7 Crankshaft Positions for Adjusting Hydraulic Valve Lifters

460" V8 ENGINE (Cont.)

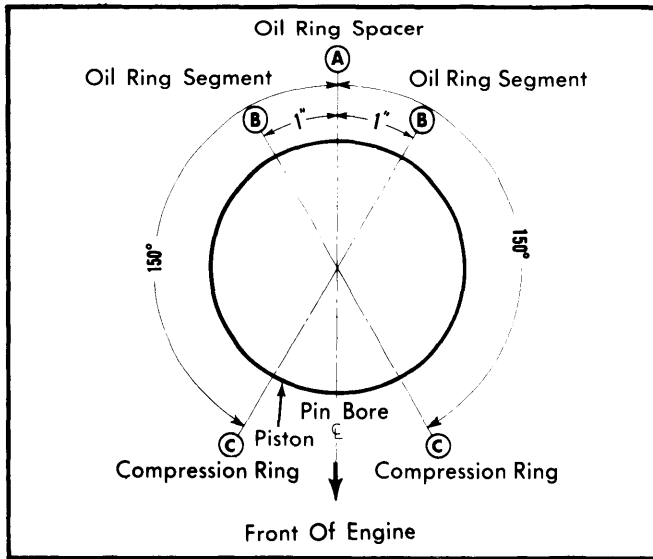

Fig. 8 Correct Spacing for Piston Rings

2) Ensure that all connecting rods and caps are marked so they can be installed in their original positions. Remove rod cap and push piston and rod assembly out top of cylinder taking care not to damage crankshaft journal or cylinder wall.

Installation - 1) Lightly coat cylinder bore, piston and rings with engine oil. Ensure that ring gaps are properly spaced as shown in Fig. 8. Install a ring compressor on piston.

2) Install piston into respective cylinder bore with notch in piston head towards front of engine. Carefully push piston into cylinder until it is slightly below top of cylinder. Install connecting rod bearings and coat bearings and crankshaft journal with engine oil. Pull piston and rod assembly down onto journal and install rod cap. Install rod cap nuts and tighten.

FITTING PISTONS

Measure piston at centerline of piston pin bore 90° to pin bore axis. Measure cylinder bore at right angle to centerline of crankshaft, below ring travel. Piston to bore clearance should be as shown in Pistons, Pins, Rings table. Check piston for color code when determining clearance. Check Piston Code Chart to determine correct size.

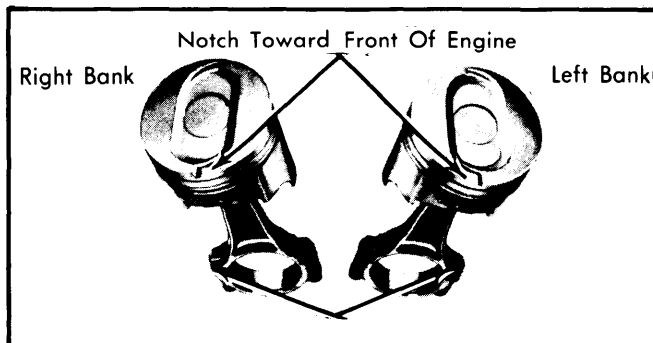

Fig. 9 Piston and Connecting Rod Assembly

Piston Code Chart

Code	Size
Red	4.3585-4.3591"
Blue	4.3597-4.3603"
.003" Oversize	4.3609-4.3615"

PISTON PINS

Pins are a press fit in connecting rods. Use a suitable tool (T65L-6135-C) and arbor press as shown in Fig. 10 for removal and installation of piston pins. Pins are pressed through piston body and connecting rod until end of pin is 1/16-1/8" below chamfer of pin bore in piston.

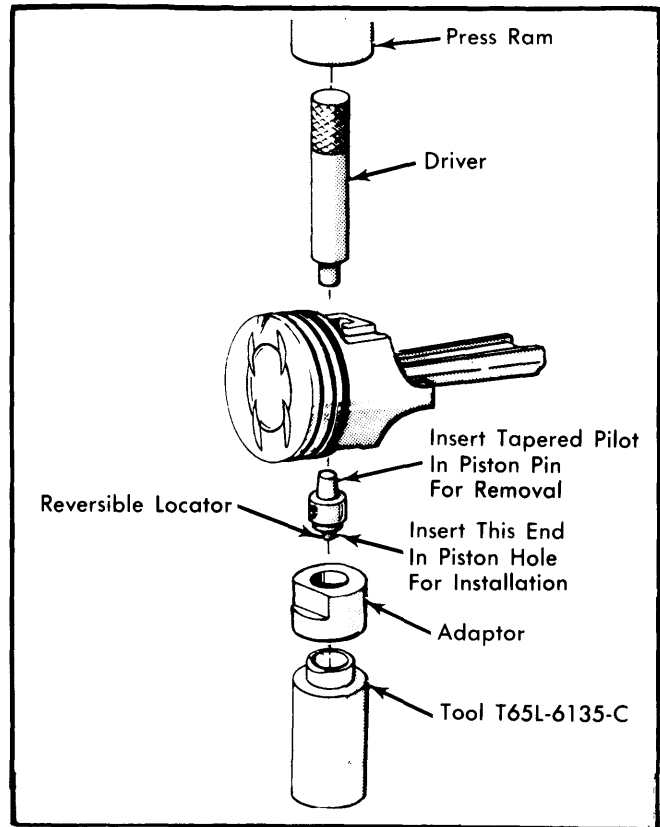

Fig. 10 Removing and Installing Piston Pin

CRANKSHAFT & ROD BEARINGS

MAIN & CONNECTING ROD BEARINGS

Connecting Rod Bearing - After ensuring rod caps are marked for cylinder identification, remove rod caps (with crankshaft journal of cylinder to be checked at bottom of throw). Use Plastigage method to check for proper clearances. New bearings are available in standard, .001" and .002" undersize. Selective fitting is required on each rod. A standard bearing half may be used in combination with a .001" undersize or a .002" undersize with a .001" undersize. Coat bearing

460" V8 ENGINE (Cont.)

surfaces with oil, install rod cap and tighten. Rotate crankshaft after bearing replacement to ensure that bearings are not too tight.

Main Bearings – 1) Mark main bearing caps for identification before removal. Remove bearing caps and upper half of main bearing. Rotate crankshaft slowly in direction of engine rotation to force upper half of bearing out.

NOTE – Replace one bearing at a time, leaving other bearings secured until ready to be changed.

2) Determine crankshaft bearing journal clearance using Plastigage method. When checking main bearings, place jack under counterweight adjoining bearing being checked. Place Plastigage on bearing surface over full width of cap and about $\frac{1}{4}$ " off center. Install cap and tighten to specified tightness. Remove cap and check with gauge provided. New bearings are available in standard, .001" and .002" undersize.

3) To install upper main bearing, lubricate bearing with engine oil and place plain end of bearing over shaft on locking tang side of block. Insert bearing and rotate crankshaft in op-

posite direction of engine rotation until bearing tang is seated. Install bearing cap and tighten.

THRUST BEARING ALIGNMENT

Install all bearing caps except thrust bearing cap and tighten bolts. Install thrust bearing cap with bolts finger tight. Pry crankshaft to front of engine and hold it forward while prying thrust cap to rear. Hold crankshaft forward and tighten cap bolts. Check crankshaft end play.

REAR MAIN BEARING OIL SEAL

Split, lip-type oil seal may be installed (upper and lower halves) without removing crankshaft from engine. After removing oil pan and oil pump, proceed as follows:

Removal – 1) Loosen all main bearing cap bolts, allowing crankshaft to drop not more than $\frac{1}{32}$ ". Remove rear main bearing cap, remove oil seal from cap and clean oil seal groove.

2) Remove upper seal half from cylinder block. Use seal removal tool or install metal screw in end of seal and pull seal from groove.

CAUTION – Extreme care should be taken not to scratch or mar crankshaft seal surface.

Installation – 1) Dip upper and lower halves of new seal in engine oil. Remove oil seal retaining pin from bearing cap and discard. Pin is not used with lip-type seal. Install upper seal half in cylinder block so that $\frac{3}{8}$ " protrudes below parting surface.

2) Tighten remaining bearing caps. Install lower half of seal in rear main bearing cap so that $\frac{3}{8}$ " protrudes above parting surface. Apply light coat of oil resistant sealer to rear of top mating surface of bearing cap. Install cap and tighten bolts.

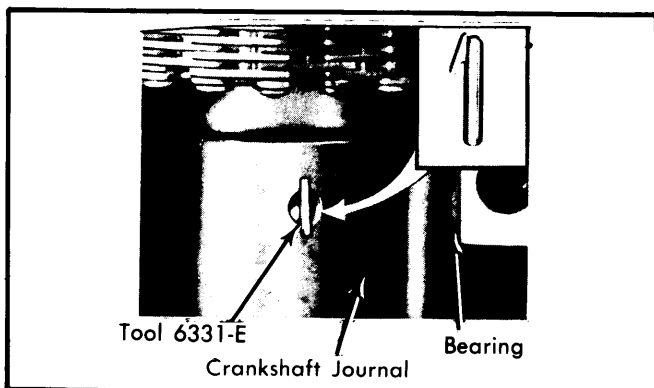

Fig. 11 Removal and Installation of Upper Main Bearing

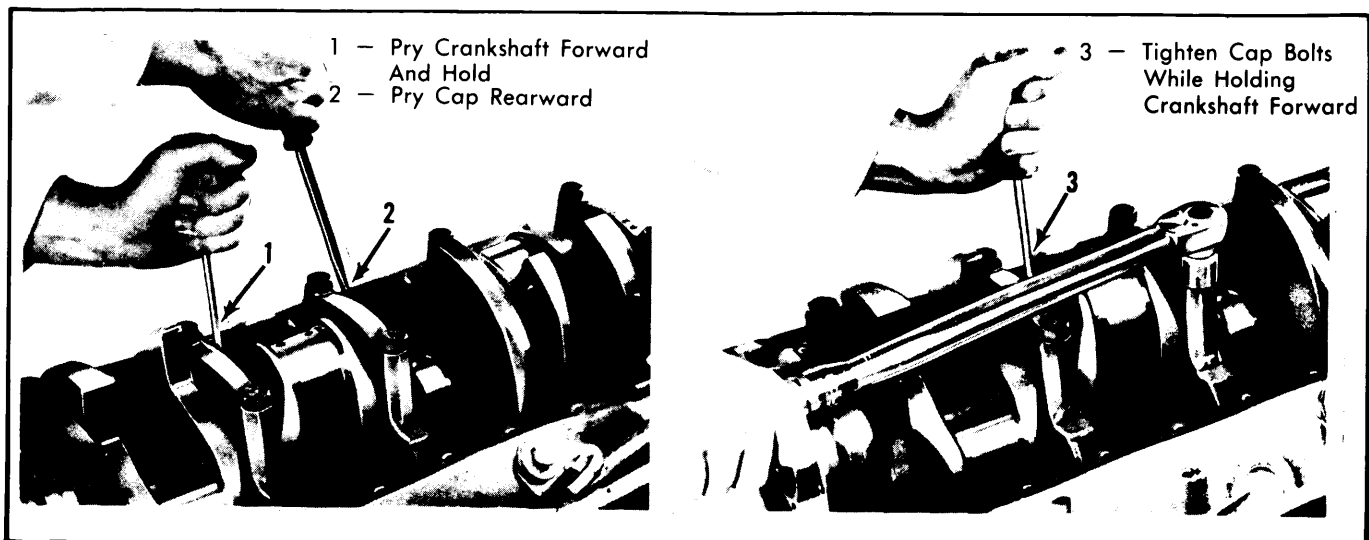

Fig. 12 Aligning Thrust Bearing

460" V8 ENGINE (Cont.)

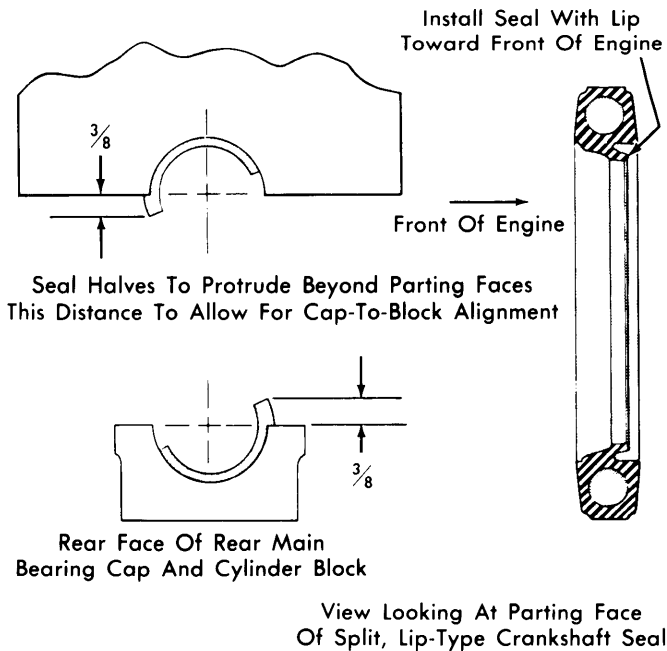

Fig. 13 Installing the Crankshaft Rear Oil Seal

CAMSHAFT

ENGINE FRONT COVER

- Removal** – 1) Drain cooling system and crankcase. Remove fan and radiator shroud. Disconnect radiator hoses at engine and oil cooler lines at radiator and remove radiator.
- 2) Remove all drive belts and water pump pulley. Remove air conditioning compressor support (if equipped). Remove crankshaft pulley from vibration damper. Remove bolt attaching crankshaft damper and remove damper using suitable puller. Remove Woodruff key.
- 3) Loosen by-pass hose at water pump and disconnect heater return tube at water pump. Disconnect and plug fuel lines at fuel pump and remove fuel pump.
- 4) Remove bolts attaching front cover to cylinder block. Using a thin blade knife, cut oil pan seal flush with cylinder block face prior to separating cover from block. Remove front cover and water pump as an assembly.

Installation – 1) Coat gasket surface of oil pan with sealer. Cut and position required section of a new seal on oil pan. Apply sealer to front cover and cylinder block gasket surfaces.

2) Position front cover on cylinder block. Install front cover to seal alignment tool into proper position as shown in Fig. 14.

NOTE – Use care when installing cover to avoid seal damage or possible misalignment.

3) Install cover attaching bolts, and while pushing in on alignment tool, tighten oil pan-to-cover bolts, and cover-to-cylinder

block bolts. To install remaining components, reverse removal procedure.

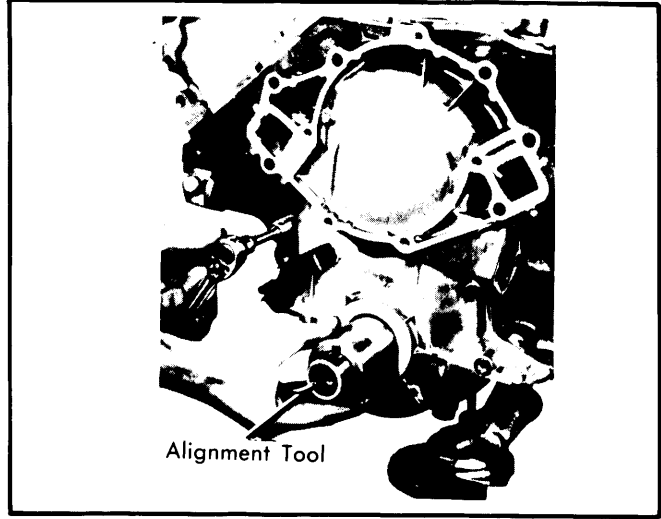

Fig. 14 Aligning Front Cover

FRONT COVER OIL SEAL

With engine front cover removed, drive out old oil seal with a pin punch and clean seal recess in front cover. To install, coat new seal with grease and install seal using installing tool T68P6700-A (or equivalent).

NOTE – After installation, ensure seal spring remains in proper position.

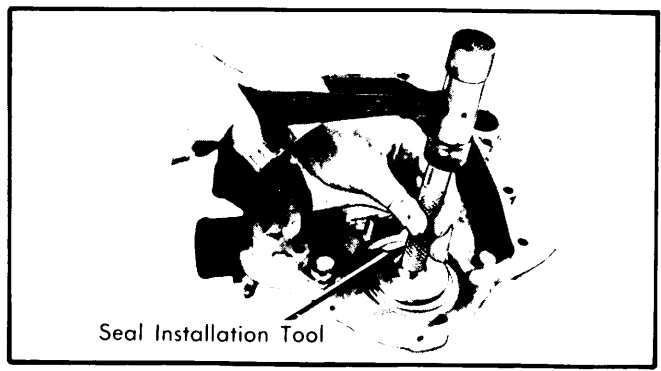

Fig. 15 Installing Front Cover Oil Seal

TIMING CHAIN & SPROCKETS

Removal – With engine front cover removed, crank engine until timing marks on sprockets are aligned as shown in Fig. 16. Remove camshaft sprocket cap screw, washer, fuel pump eccentric, and front oil slinger. Slide timing chain and sprockets forward, and remove as an assembly.

Installation – Assemble timing chain and sprockets so sprocket timing marks are aligned as shown in Fig. 16. Install chain and sprockets as an assembly to crankshaft and camshaft. To install remaining components, reverse removal procedure and lubricate timing chain with engine oil.

460" V8 ENGINE (Cont.)

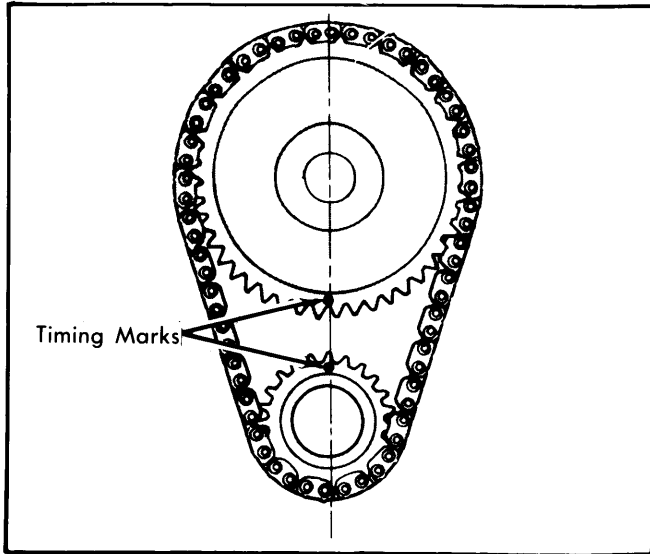

Fig. 16 Aligning Timing Marks

CAMSHAFT

Removal — 1) Remove timing chain and sprockets and intake manifold. Remove rocker arm covers and back off all rocker arm bolts. Turn rocker arms sideways and remove push rods and valve lifters, keeping them in order for installation in their original positions.

2) Remove radiator and bolts attaching air conditioning condenser (if equipped) to chassis. Carefully move condenser to

rest on left fender. Remove grille. Remove camshaft thrust plate attaching bolts and carefully remove camshaft from front of engine.

Installation — Oil camshaft journals and apply Lubriplate or equivalent to cam lobes. Carefully slide camshaft into position and install thrust plate attaching bolts. To install remaining parts, reverse removal procedure.

CAMSHAFT BEARINGS

With engine removed and placed in work stand, remove camshaft, flywheel, rear cover plate and crankshaft. Remove camshaft rear bearing bore plug by drilling $\frac{1}{2}$ " hole in center of plug. Pull plug with tool T59L-100-B and T50T-100-A (or equivalent). Remove bearing using proper size expanding collet and back-up nut assembled on expanding mandrel. Use same procedure to install bearings. Oil holes in bearings and cylinder block should be aligned. Front bearings should be installed .040-.060" from face of cylinder block. Coat new rear bore plug with sealer and install. See Fig. 18.

CAMSHAFT END PLAY

To check end play, push camshaft towards rear of engine. Install dial indicator so that indicator point is on camshaft sprocket attaching screw. Pull camshaft forward and check dial indicator reading to obtain end play. If end play is excessive, replace camshaft thrust plate.

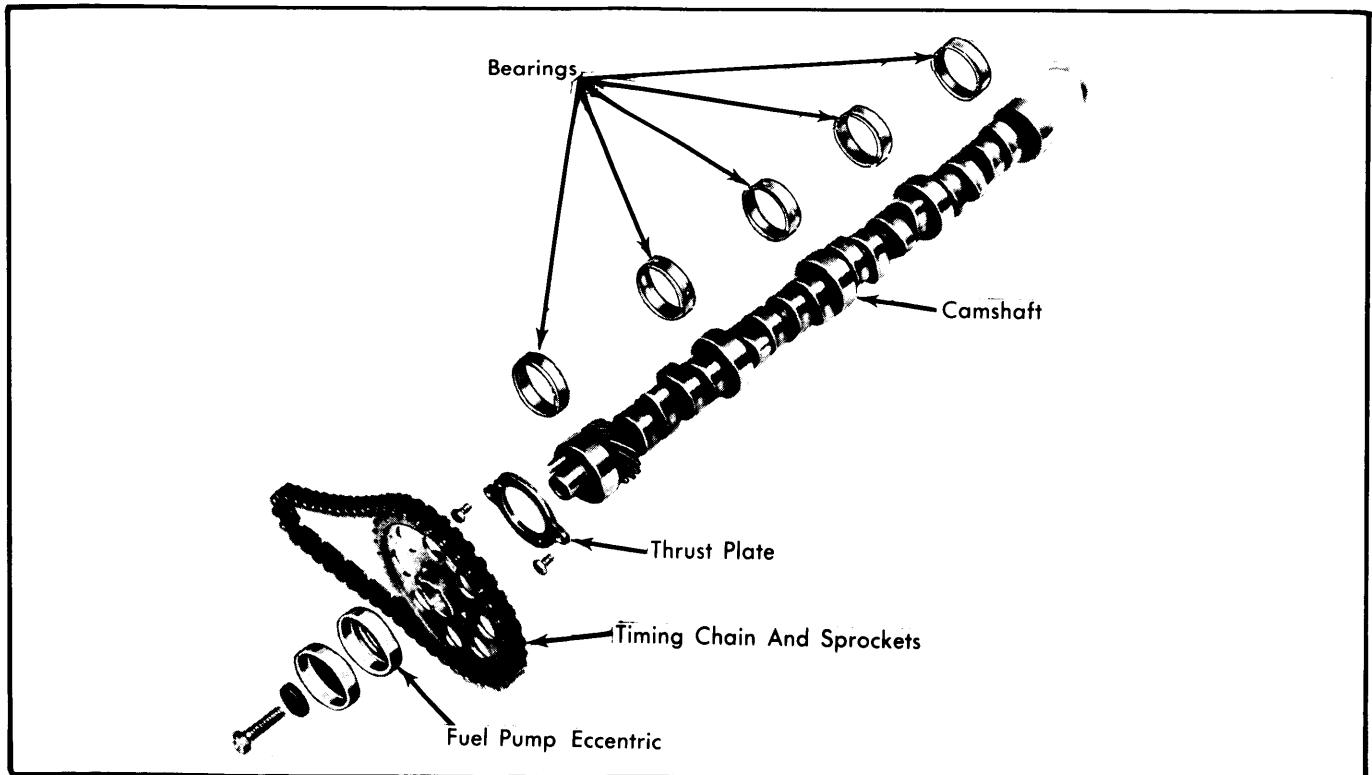

Fig. 17 Exploded View of Camshaft Assembly

460" V8 ENGINE (Cont.)

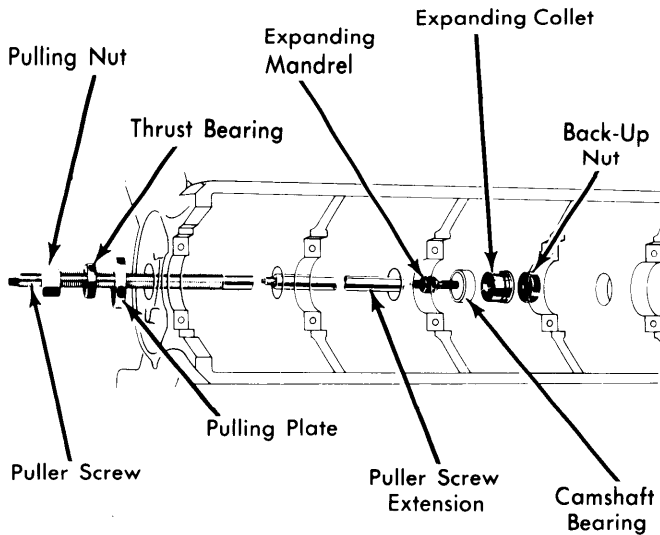

Fig. 18 Replacing Camshaft Bearings

ENGINE OILING

Crankcase Capacity — 5 qts., add 1 qt. with filter change.

Oil Filter — Change filter after first 6,000 miles and at alternate oil changes thereafter. To install, coat gasket with oil, screw filter onto adapter by hand until snug, then tighten an additional 1/2 turn.

Normal Oil Pressure — With engine at normal operating temperature, oil pressure should be 40-65 lbs. at 2,000 RPM.

Pressure Regulator Valve — In pump body. Not adjustable.

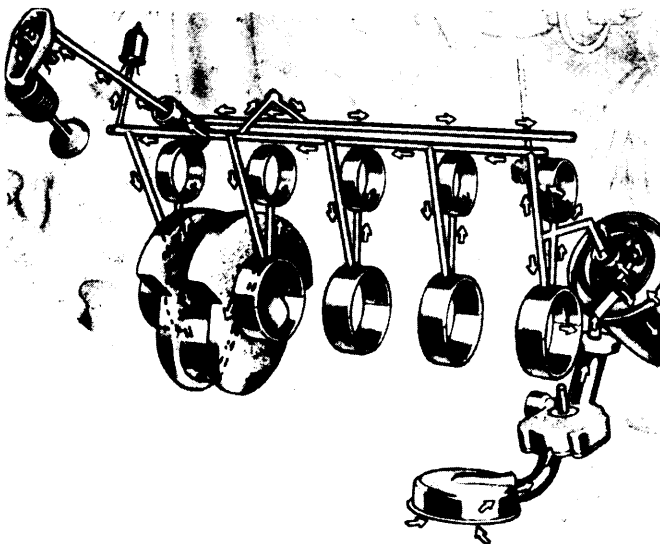

Fig. 19 Engine Oiling System

ENGINE OILING SYSTEM

Oil pump driven by distributor, provides full pressure lubrication to all camshaft and crankshaft bearings. Engine feeds oil through hydraulic valve lifters and hollow push rods to rocker arms and upper valve train area. Timing chain and sprockets are lubricated by drainage from No. 1 camshaft bearing.

OIL PUMP

Oil pump is rotor type, mounted inside oil pan on lower left corner of block. Oil pump is driven by distributor through an intermediate shaft.

Disassembly — With oil pump removed, remove cover screws and separate cover from pump body. Remove oil pump outer rotor and rotor shaft assembly from pump housing. Remove cotter pin securing relief valve plug. To remove plug, drill a small hole in plug and insert a self-tapping screw. Use pliers to remove plug from housing as shown in Fig. 20. Remove spring and relief valve from pump housing.

Assembly — Clean, inspect, and oil all parts thoroughly. Check all clearances (see specifications). Install relief valve, spring and plug in housing. Press plug in until it seats, then install cotter pin. Install outer rotor and rotor shaft into housing.

NOTE — Identification marks should face same direction. Rotor and shaft assembly, and outer rotor are serviced as an assembly. Install cover and tighten cover bolts.

Oil Pump Specifications

Application	Specification
Relief Valve Spring Tension	20.6-22.6 lbs. @ 2.49"
Relief Valve Clearance0030"
Drive Shaft-to-Housing Clearance0030"
Rotor End Play Clearance004" Max.
Outer Race-to-Housing Clearance001-.013"

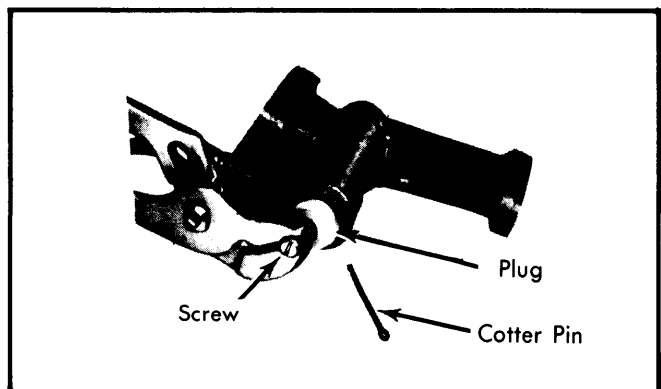

Fig. 20 Removing Oil Pump Relief Valve Plug

460" V8 ENGINE (Cont.)

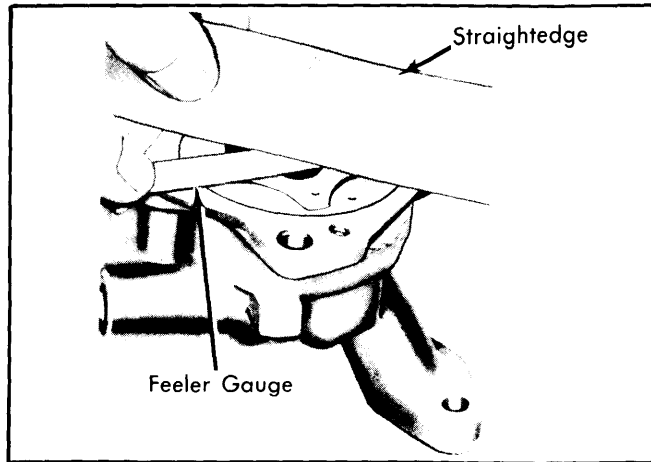

Fig. 21 Checking Clearance for Outer Race-to-Housing

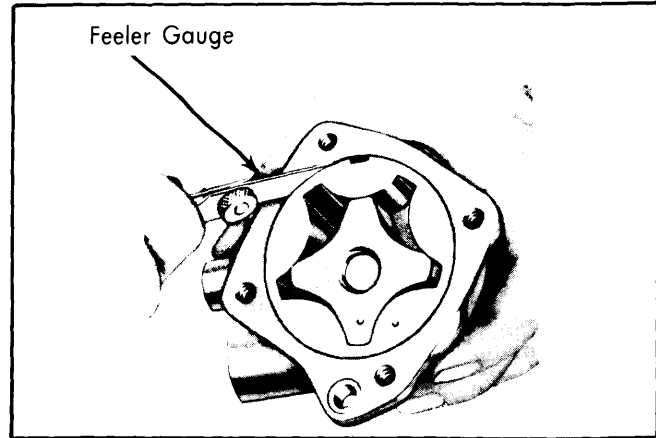

Fig. 22 Checking Rotor End Play

ENGINE SPECIFICATIONS

GENERAL SPECIFICATIONS							
Year	Displ. Cu. Ins.	Carburetor	HP at RPM	Torque (Ft. Lbs. at RPM)	Compr. Ratio	Bore	Stroke
1978	460"	4-Bbl.	4.36"	3.85"

VALVES							
Engine & Valve	Head Diam.	Face Angle	Seat Angle	Seat Width	Stem Diameter	Stem Clearance	Valve Lift
460"							
Int.	2.075-2.0090"	44°	45°	.060-.080"	.3416-.3423"	.0010-.0027"	.4377"
Exh.	1.646-1.661"	44°	45°	.060-.080"	.3416-.3423"	.0010-.0027"	.4809"

PISTONS, PINS, RINGS						
Engine	PISTONS	PINS		RINGS		
	Clearance	Piston Fit	Rod Fit	Rings	End Gap	Side Clearance
460"	.0022-.0030"	.0002-.0004"	Interference Fit	1	.010-.020"	.0025-.0045"
				2	.010-.020"	.0025-.0045"
				3	.010-.030"	⓪

⓪ — Ring should be snug fit in groove.

CRANKSHAFT MAIN & CONNECTING ROD BEARINGS							
Engine	MAIN BEARINGS				CONNECTING ROD BEARINGS		
	Journal Diam.	Clearance	Thrust Bearing	Crankshaft End Play	Journal Diam.	Clearance	Side Play
460"	2.9994-3.0002"	⓪.0008-.0015"	No. 3	.004-.008"	2.4992-2.5000"	⓪.0008-.0015"	.010-.020"

⓪ — Allowable clearance is .0004-.0020" for journal No. 1 and .0008-.0026" journal Nos. 2, 3, 4 and 5.

⓪ — Allowable clearance is .0008-.0026".

460" V8 ENGINE (Cont.) ENGINE SPECIFICATIONS (Cont.)

VALVE SPRINGS			
Engine	Free Length	PRESSURE (LBS.)	
		Valve Closed	Valve Open
460"	2.07"	76-84@2.06"	218-240@1.33"

CAMSHAFT			
Engine	Journal Diam.	Clearance	Lobe Lift
460"	2.1238-2.1248"	.001-.003" ①	Int. .2530" Exh. .2780"

① — End play is .003-.007".

TIGHTENING SPECIFICATIONS	
Application	Ft. Lbs.
Cylinder Head Bolts	
Step One	80
Step Two	110
Step Three	130-140
Main Bearing Cap Bolts	95-105
Connecting Rod Cap Bolts	40-45
Intake Manifold Bolts	22-32
Exhaust Manifold Bolts	28-33
Flywheel-to-Crankshaft Bolts	75-85
Engine Front Cover Bolts	12-18
Camshaft Sprocket Bolts	40-45
Crankshaft Pulley Bolts	35-50
Oil Pan-to-Cylinder Block Bolts	
5/16"	9-11
1/4"	7-9
Valve Rocker Arm Cover Bolts	5-6