

302" & 351-W" V8 ENGINES

| GENERAL SPECIFICATIONS | | | | | | | |
|------------------------|--------------------|------------|-----------|-----------------------------|-----------------|-------|--------|
| Year | Displ. Cu. Ins. | Carburetor | HP at RPM | Torque (Ft. Lbs. at RPM) | Compr. Ratio | Bore | Stroke |
| 1976 | 302" | 2-Bbl. | | | | 4.00" | 3.00" |
| | 351-W" | 2-Bbl. | | | | | 3.50" |

ENGINE IDENTIFICATION

Rating plate carries information concerning vehicle model, series, point of manufacture, and unit number. Plate is located on cowl surface under hood. Number code is as follows:

U15GDC50000

First Digit - Truck Series Letter.

Second & Third Digits - Truck Series Number.

Fourth Digit - Engine Code.

Fifth Digit - Assembly Plant.

Remaining Digits - Consecutive Unit Number.

V8 Engine Identification Codes

| Engine | Code Letter |
|--------------------|-------------|
| 302" 2-Bbl. | G |
| 351-W" 2-Bbl. | H |

ENGINE REMOVAL

See *Engine Removal* at end of *ENGINE* Section.

INTAKE MANIFOLD

Removal - 1) Drain cooling system. Remove air cleaner and duct assembly. Disconnect accelerator rod, choke cable, and kickdown rod at carburetor. Remove accelerator retracting spring. Disconnect high-tension lead and wires from coil. Disconnect spark plug wires from plugs, then remove distributor cap and wires as an assembly.

2) Remove fuel inlet line at carburetor. Disconnect distributor vacuum lines and remove distributor. Disconnect radiator and heater hoses at intake manifold and water pump. Disconnect temperature sending unit wire. Disconnect crankcase vent hose at rocker arm cover. Remove intake manifold attaching bolts, then remove manifold and carburetor as an assembly. Remove and discard gaskets and seals. Discard attaching bolt sealing washers.

Installation - 1) Clean all gasket surfaces thoroughly and apply suitable oil resistant sealer at four points of gasket-to-gasket contact. Position manifold gaskets (valley baffle on 351-W") on surface of cylinder heads. Lock front and rear sealing gaskets into tabs on manifold gaskets. Check that all gaskets are aligned properly.

2) Lower manifold into position taking care not to misalign manifold gaskets. Install manifold bolts, tighten in two steps in sequence shown in *Fig. 1*. Reverse removal procedure to install remaining components. Warm engine to normal operating temperature, shut off engine, and retighten manifold bolts to specifications.

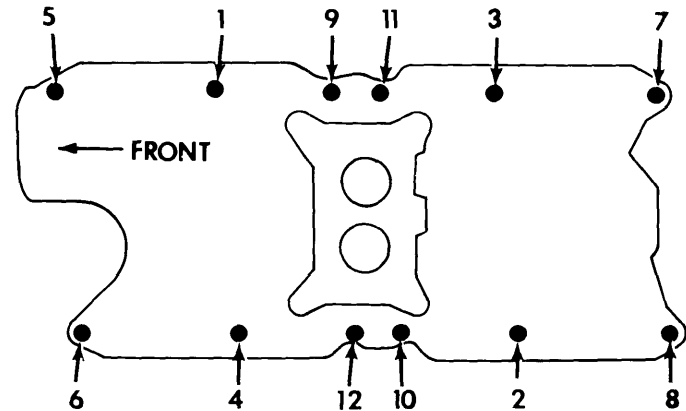

Fig. 1 Tightening Sequence for Intake Manifold

CYLINDER HEAD

Removal - 1) Remove intake manifold and rocker arm covers. If right cylinder head is to be removed, remove alternator mounting bracket bolt, and swing alternator down and to one side, then remove ignition coil and air cleaner inlet duct. If left cylinder head is to be removed, remove accelerator shaft assembly from head.

2) Disconnect exhaust manifold from muffler pipe. Loosen rocker arm stud nuts to allow rocker arms to be rotated to one side. Remove push rods in sequence for reinstallation in original positions. Remove exhaust valve caps (302" only). Remove cylinder head attaching bolts and lift head off engine.

Installation - Clean all gasket surfaces thoroughly. Check cylinder head and block for flatness if cylinder head was removed for gasket replacement. Position new cylinder head gasket over dowel pins on block surface. *NOTE* - A specially treated composition gasket is used and does not require sealer. Install cylinder heads and bolts. Tighten bolts, in three steps, in sequence as shown in *Fig. 2*. Reverse removal procedure for remaining components.

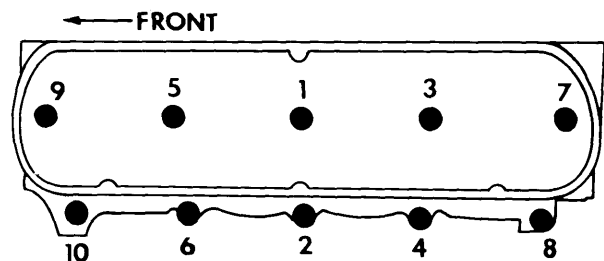

Fig. 2 Tightening Sequence for Cylinder Head

302" & 351-W" V8 ENGINES (Cont.)

| VALVES | | | | | | | |
|----------------|--------------|------------|------------|------------|---------------|----------------|------------|
| Engine & Valve | Head Diam. | Face Angle | Seat Angle | Seat Width | Stem Diameter | Stem Clearance | Valve Lift |
| 302" & 351-W" | | | | | | | |
| Intake | 1.773-1.791" | 44° | 45° | .060-.080" | .3416-.3423" | .0010-.0027" | .3707" |
| Exhaust | 1.453-1.468" | 44° | 45° | .060-.080" | .3411-.3418" | .0015-.0032" | .3823" |

VALVE ARRANGEMENT

E-I-E-I-E-I-E-I (Left bank, front to rear).
 I-E-I-E-I-E-I-E (Right Bank, front to rear).

VALVE GUIDE SERVICING

To ream guides for installation of valves with oversize stems, always use reamers in size sequence and reface valve seat after valve guide is reamed. Reamers are furnished .003" oversize with standard diameter pilot; .015" oversize reamer with .003" oversize pilot; and .030" oversize reamer with .015" oversize pilot. **NOTE** — Use suitable scraper tool to break sharp corner (ID) at top of valve guide after reaming.

VALVE STEM OIL SEALS

Cup or umbrella type seals are used on all valves. Install seals with cup side down over valve guide.

| VALVE SPRINGS | | | |
|---------------|-------------|-----------------|---------------|
| Engine | Free Length | PRESSURE (LBS.) | |
| | | Valve Closed | Valve Open |
| 302" | | | |
| Int. | 1.94" | 76-84@1.69" | 190-210@1.31" |
| Exh. | 1.85" | 76-84@1.69" | 190-210@1.31" |
| 351-W" | | | |
| Int. | 2.06" | 71-79@1.79" | 190-210@1.34" |
| Exh. | 2.12" | 71-79@1.79" | 190-210@1.34" |

VALVE SPRINGS

Removal — 1) Remove air cleaner, crankcase ventilation regulator valve, and any Thermactor air hoses (if equipped) as necessary from rocker arm cover(s), remove cover(s). Remove spark plug from any cylinder to be serviced.

2) Install air line with adapter into spark plug hole. Remove appropriate rocker arm(s) and push rod(s). On 302" engine, remove exhaust valve stem caps. Use suitable spring compression tool to compress valve and remove retainer locks. **NOTE** — If air pressure fails to hold valve closed, remove cylinder head for inspection of valve seat area. Remove and discard valve stem seal after removing spring retainer, and valve spring. **CAUTION** — Do not remove air pressure from cylinder as this will allow valve to fall into cylinder if piston has been forced to bottom of cylinder.

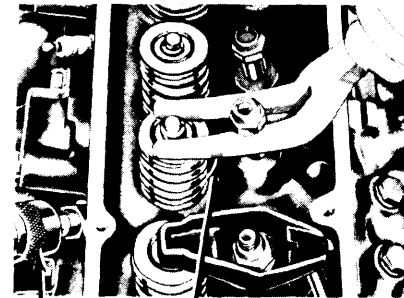

Air Line

Tool T62F-6565-A or 6513-HH

Fig. 3 Compressing Valve Springs for Removal

Installation — 1) Lubricate valve stem with engine oil and install new valve stem seal. Place spring in position over valve and position spring retainer and sleeve. Compress valve spring and install retainer locks.

2) Apply Lubriplate or equivalent to end of push rods and tip of valve stem. Install valve stem caps on 302" engine. Install rocker arms and tighten. Replace all parts removed in reverse of removal procedure.

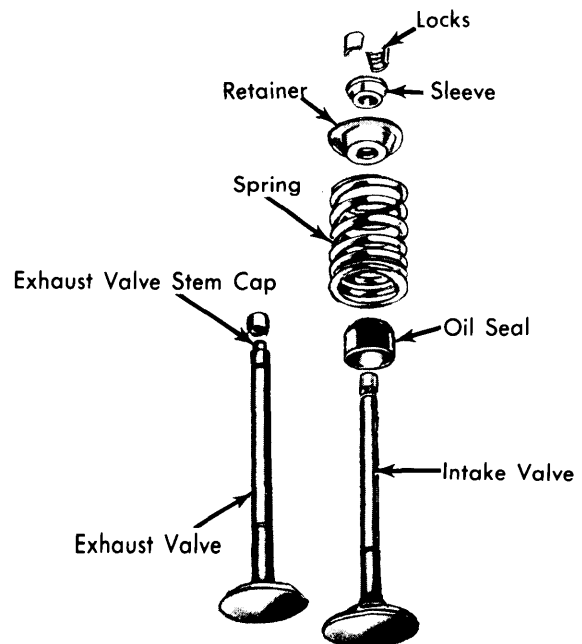

Fig. 4 Exploded View of Valve Assemblies

302" & 351-W" V8 ENGINES (Cont.)

VALVE SPRING INSTALLED HEIGHT

Valve spring ends must be square within $\frac{5}{64}$ " tolerance. Installed height of valve spring must not exceed specifications. Measure spring height from surface of cylinder head pad to underside of spring retainer. If height is greater than specified, install .030" spacer on head under spring to bring height within limits. **CAUTION** — Install spacers only if necessary and do not use more than two spacers as any more will overstress springs and overload camshaft lobes.

Valve Spring Installed Height Specifications

| Application | Installed Height |
|-------------|---|
| 302" | |
| Int..... | $1\frac{13}{64}$ " - $1\frac{15}{64}$ " |
| Exh..... | $1\frac{19}{32}$ " - $1\frac{39}{64}$ " |
| 351-W" | |
| Int..... | $1\frac{49}{64}$ " - $1\frac{13}{16}$ " |
| Exh..... | $1\frac{13}{16}$ " - $1\frac{27}{32}$ " |

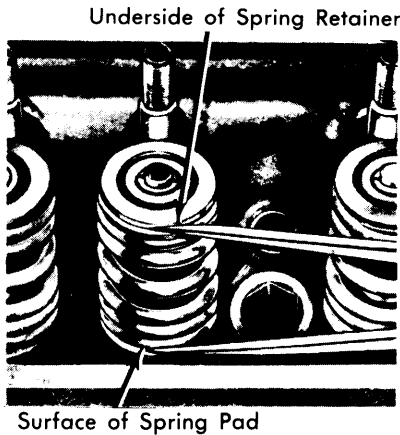

Fig. 5 Checking Installed Height of Valve Spring

ROCKER ARM ASSEMBLY

Inspect rocker arms, fulcrum seats, rocker arm stud nuts, and rocker studs for undue or excessive wear. Replace all parts which show fatigue.

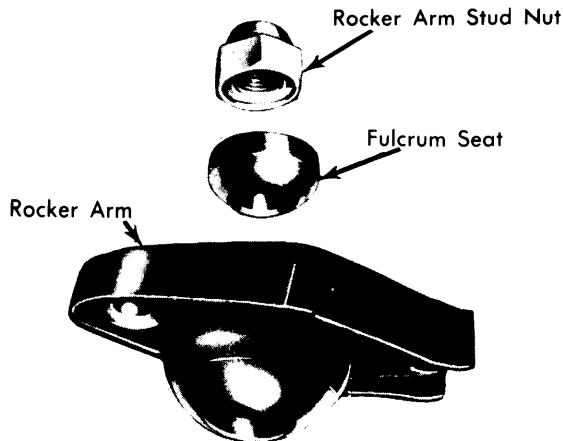

Fig. 6 Rocker Arm Assembly

ROCKER ARM STUDS

Removal — Studs with worn or damaged threads can be removed using suitable stud pulling tool. Broken studs will require use of drill or screw extractor tool. Loose studs will need stud boss reamed to fit oversize studs.

Replacement — Normal stud replacement requires only use of suitable stud driver which will contact stud boss when stud is driven in to correct height. If oversize stud is needed, use reamers in sequence to obtain correct size. Studs are available in .006", .010", and .015" oversizes. Use suitable stud driver to install oversize stud to correct height.

HYDRAULIC VALVE LIFTER ASSEMBLY

Lifters should be serviced as assemblies only, internal parts are matched sets and cannot be interchanged. Leak down rate on hydraulic lifters is 5-50 seconds at $\frac{1}{16}$ " plunger travel using suitable leak down rate tester. Replace lifter assembly if any sign of malfunction occurs.

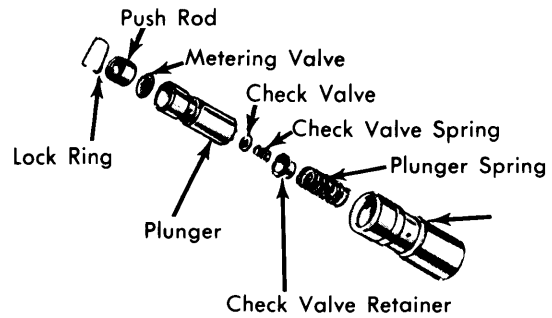

Fig. 7 Disassembled View of Hydraulic Valve Lifter

HYDRAULIC VALVE LIFTER ADJUSTMENT

Positive stop rocker arm stud eliminates necessity of adjusting valve clearance, but to obtain specified valve clearance it is important that all valve components be in serviceable condition, and installed and tightened properly. With crankshaft in positions designated in following procedure, back off stud nut approximately two turns. Turn stud nut clockwise until stop is contacted, tighten nut and proceed as follows:

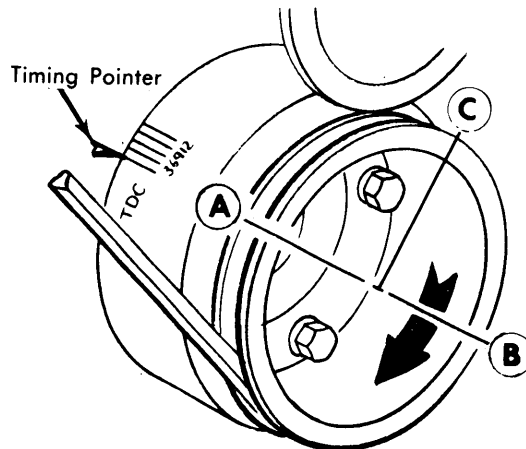

Fig. 8 Crankshaft Positions for Adjusting Hydraulic Valve Lifters

302" & 351-W" V8 ENGINES (Cont.)

302" Engine — 1) With No. 1 piston on TDC at end of compression stroke (position A in Fig. 8), set valve clearance on the following valves: No. 1 intake, No. 1 exhaust, No. 7 intake, No. 5 exhaust, No. 8 intake, No. 4 exhaust.

2) Rotate crankshaft to position B (see Fig. 8) by rotating crankshaft 180° clockwise from the TDC position. Set clearance on the following valves: No. 5 intake, No. 2 exhaust, No. 4 intake, No. 6 exhaust.

3) Rotate crankshaft to position C (see Fig. 8) by rotating crankshaft 270° clockwise from position B. Set clearance on the following valves: No. 2 intake, No. 7 exhaust, No. 3 intake, No. 3 exhaust, No. 6 intake, No. 8 exhaust

351-W" Engine — 1) With No. 1 piston on TDC at end of compression stroke (position A in Fig. 8), set valve clearance on the following valves: No. 1 intake, No. 1 exhaust, No. 4 intake, No. 3 exhaust, No. 8 intake, No. 7 exhaust.

2) Rotate crankshaft to position B (see Fig. 8) by rotating crankshaft 180° clockwise from the TDC position. Set clearance on the following valves: No. 3 intake, No. 2 exhaust, No. 7 intake, No. 6 exhaust.

3) Rotate crankshaft to position C (see Fig. 8) by rotating crankshaft 270° clockwise from position B. Set clearance on the following valves: No. 2 intake, No. 4 exhaust, No. 5 intake, No. 5 exhaust, No. 6 intake, No. 8 exhaust.

| PISTONS, PINS, RINGS | | | | | | |
|----------------------|--------------|--------------|-----------|-------|------------|----------------|
| Engine | PISTONS | PINS | | RINGS | | |
| | Clearance | Piston Fit | Rod Fit | Rings | End Gap | Side Clearance |
| 302" | .0018-.0026" | .0002-.0004" | Press Fit | 1 | .010-.020" | .0020-.0040" |
| | | | | 2 | .010-.020" | .0020-.0040" |
| | | | | 3 | .015-.055" | Snug |
| 351-W" | .0018-.0026" | .0003-.0005" | Press Fit | 1 | .010-.020" | .0020-.0040" |
| | | | | 2 | .010-.020" | .0020-.0040" |
| | | | | 3 | .015-.055" | Snug |

OIL PAN

See *Oil Pan Removal* at end of ENGINE Section.

PISTON & ROD ASSEMBLY

Removal — 1) With cylinder head and oil pan removed, use suitable ridge cutter to remove any ridge or deposits on upper end of cylinder bore. **NOTE** — *Piston must be at bottom of stroke. Place shop towel or cloth lightly soaked in oil over piston dome to collect cuttings.*

Installation — 1) Lightly coat cylinder bore, piston and rings with engine oil. Ensure that ring gaps are properly spaced as shown in Fig. 9. Install a ring compressor on piston.

2) Install each piston and rod assembly (with notch on piston head facing front of engine) in respective bore, guide connecting rod onto crankshaft journal while tapping piston dome with suitable wooden handle to seat connecting rod against crankshaft. Install rod caps and tighten.

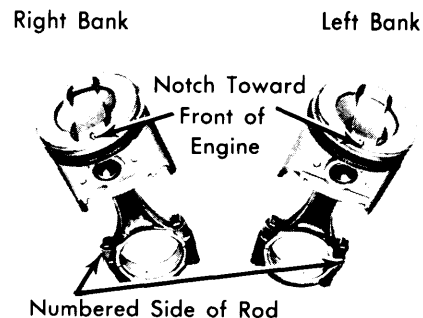
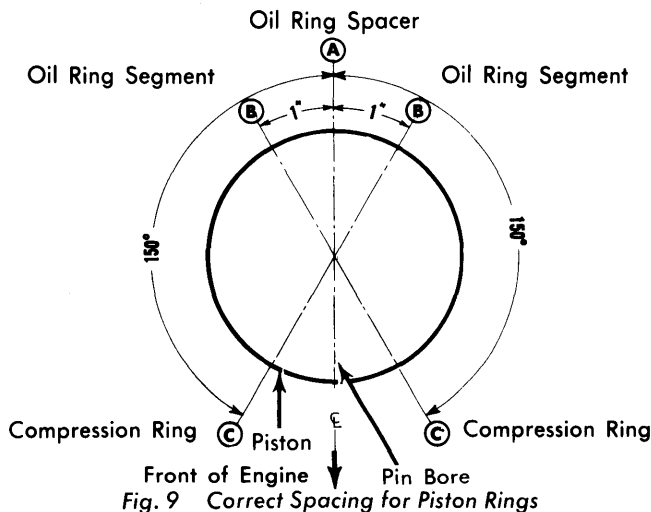

Fig. 10 Piston and Connecting Rod Assembly

2) Inspect connecting rods and caps for cylinder identification and mark as necessary. Remove rod cap and push piston and rod assembly out of top of cylinder taking care not to nick crankshaft journal or to score cylinder wall.

FITTING PISTONS

Calculate size of piston to be used by measuring cylinder bore at right angles to centerline of crankshaft below ring travel. Measure piston diameter in line with centerline of piston pin and at 90° to piston pin axis. Make sure both piston and cylinder block are at normal room temperature (70°F) when fitting.

302" & 351-W" V8 ENGINES (Cont.)

PISTON PINS

Removal — Using arbor press and suitable tools (T65L-6135-C or equivalent), press piston pin from piston and connecting rod.

Installation — Start piston pin in piston and connecting rod. Using arbor press and suitable tool (T65L-6135-C or equivalent), press piston pin through piston into connecting rod until pin is centered in connecting rod.

| CRANKSHAFT MAIN & CONNECTING ROD BEARINGS | | | | | | | |
|---|----------------|---------------|----------------|---------------------|-------------------------|--------------|------------|
| Engine | MAIN BEARINGS | | | | CONNECTING ROD BEARINGS | | |
| | Journal Diam. | Clearance | Thrust Bearing | Crankshaft End Play | Journal Diam. | Clearance | Side Play |
| 302" | 2.2482-2.2490" | ①.0005-.0015" | No. 3 | .004-.008" | 2.1228-2.1236" | .0008-.0015" | .010-.020" |
| 351-W" | 2.9994-3.0002" | ②.0008-.0015" | No. 3 | .004-.008" | 2.3103-2.3111" | .0008-.0015" | .010-.020" |

① — No. 1 is .0001-.0015".

② — No. 1 is .0005-.0015".

MAIN & CONNECTING ROD BEARINGS

Removal — Remove oil pan and related parts following procedure outlined in Oil Pan Removal. Proceed as follows:

1) To change connecting rod bearings, remove and inspect connecting rod caps for cylinder identification to ensure correct position for replacement. With crankshaft lined up in center of cylinder bore, push piston upward into block enough to allow removal of upper half of bearing.

2) Mark main bearing caps for identification purposes before removal from block. Remove upper half of main bearing by inserting suitable tool (6331-B or equivalent) in oil hole of crankshaft and slowly rotate crankshaft in direction of engine rotation to force out upper half of main bearing. **NOTE** — Replace only one bearing at a time leaving other bearings secured until ready to change.

Installation — Thoroughly clean all parts and bearing surfaces and proceed as follows:

1) Determine crankshaft bearing journal clearance using Plastigage method. When checking main bearings, place a jack under counterweight adjoining bearing being gauged to avoid weight of crankshaft compressing Plastigage and giving erroneous readings.

2) If bearing clearance is excessive, a .001" or .002" undersize bearing half may be used in combination with a standard size bearing half. If .002" undersize bearings are used on more than one journal, they may be positioned in engine block rather than bearing cap. If standard and .002" undersize combination did not bring bearing clearance within specified limits, crankshaft will have to be refinished and suitable undersize bearings installed.

3) After rod bearings have been fitted using Plastigage method, apply light coat of engine oil to journals and bearings. With crankshaft throw to bottom of stroke and upper half of bearing installed, move piston down until connecting rod bearing seats on crank journal. Install connecting rod cap and tighten. Check connecting rod side clearance.

4) To install upper main bearing, lubricate bearing with engine oil and place plain end of bearing over crankshaft on locking tang side of block. Partially insert bearing to allow

suitable tool (6331-E or equivalent) to be inserted into oil hole in crankshaft journal. Rotate crankshaft in opposite direction of engine rotation until bearing tang is seated. Remove bearing tool, install bearing cap and tighten.

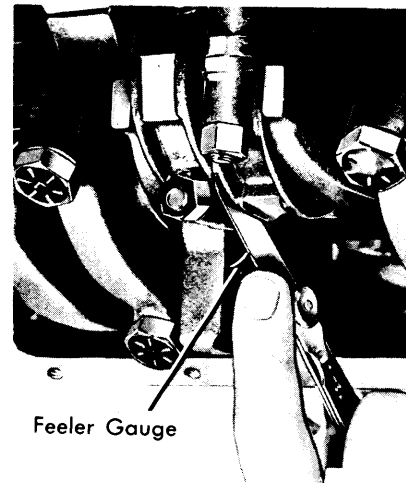

Fig. 11 Measuring Connecting Rod Side Clearance

THRUST BEARING ALIGNMENT

Install thrust bearing cap after all other main caps have been tightened. Install thrust bearing cap with bolts finger tight. Pry crankshaft forward against thrust surface of upper half of bearing. Hold crankshaft forward and pry thrust bearing cap to rear, this will align thrust surfaces of both halves of bearing. Retain forward pressure on crankshaft and torque cap bolts to specifications.

REAR MAIN BEARING OIL SEAL

Removal — 1) Complete seal can be replaced without removing crankshaft. Remove oil pan and oil pump (if required), loosen all main bearing cap bolts to lower crankshaft slightly, but not to exceed $\frac{1}{32}$ ".

302" & 351-W" V8 ENGINES (Cont.)

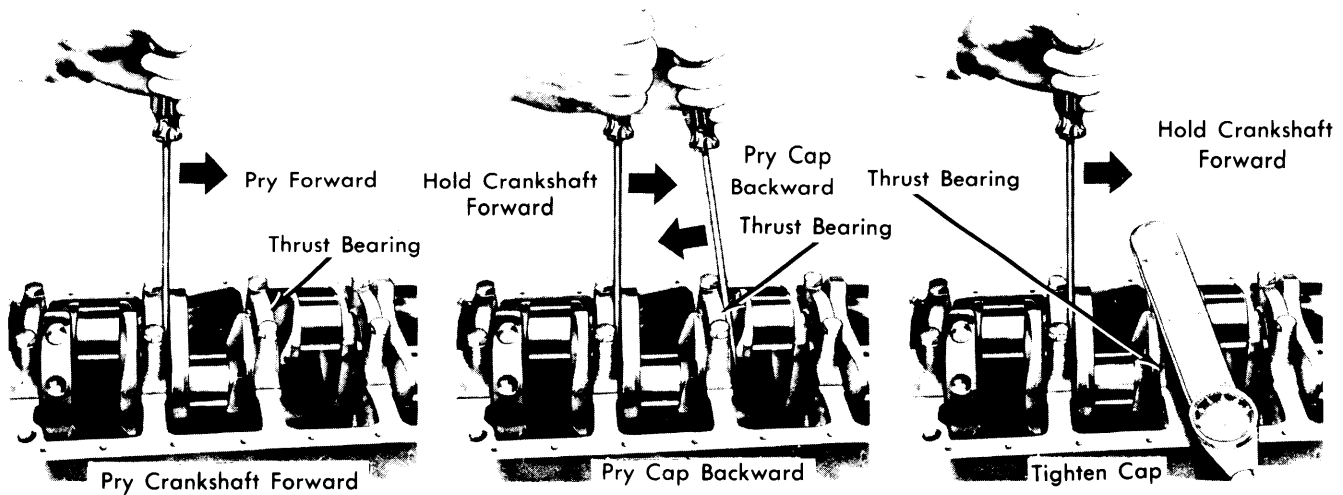

Fig. 12 Aligning the Thrust Bearing

2) Remove rear main bearing cap and remove oil seal from bearing cap and block. On block half of seal, use seal removing tool or place small metal screw in one end of seal and pull on screw to remove seal. Prevent scratching or damage to crankshaft seal surface.

3) Remove oil seal retaining pin from bearing cap if so equipped, as replacement seal does not use pin. Discard pin.

Installation — 1) Clean oil seal groove, dip split-lip type seal halves in engine oil. Carefully install block upper seal into groove with undercut side of seal toward front of engine by rotating seal on journal of crankshaft until approximately $\frac{3}{8}$ " of seal protrudes below parting surface. **CAUTION** — Avoid shaving any rubber from outside diameter of seal by bottom edge of groove. Do not allow any oil to get into sealing area.

2) Tighten remaining bearing cap bolts to torque specifications. Install lower seal in rear main bearing cap with undercut side of seal toward front of engine, allowing seal to protrude approximately $\frac{3}{8}$ " above parting surface to mate with upper seal when cap is installed.

3) Apply suitable oil-resistant sealer to bearing edges and install rear main bearing cap. Torque cap bolts to specifications and reinstall oil pump, oil pan, and all other related parts.

ENGINE FRONT COVER

Removal — Drain cooling system and crankcase. Remove fan, spacer and all hoses or brackets attaching to water pump. Remove crankshaft pulley and use suitable puller to remove vibration damper. Disconnect fuel pump outlet line from fuel pump, remove fuel pump bolts and move pump to one side. Remove front cover bolts and cut oil pan gasket flush with cylinder block. Remove front cover and water pump as an assembly.

Installation — Clean all gasket surfaces. Use suitable sealer and install gaskets and seals. Use suitable tool to center front cover on crankshaft, install bolts and tighten. Install all related parts.

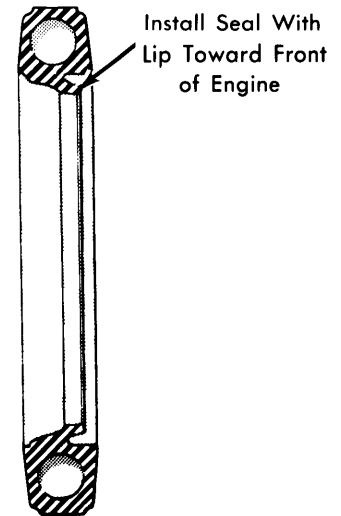

View Looking at Parting Face of Split-Lip Type Crankshaft Seal

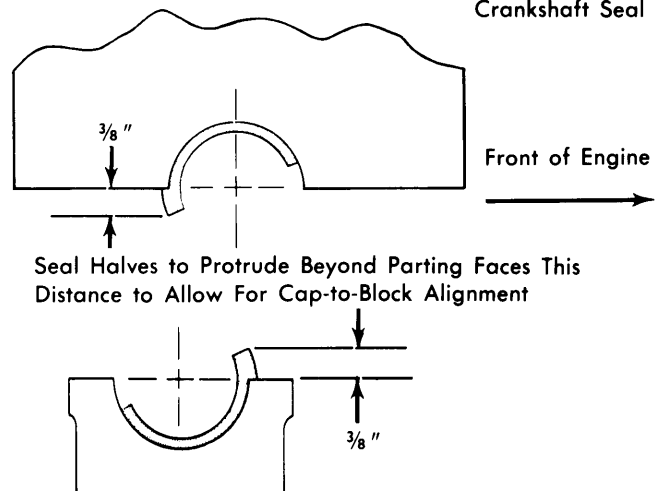

Rear Face of Rear Main Bearing Cap and Cylinder Block

Fig. 13 Installing the Crankshaft Rear Oil Seal (The 302" Engine is Shown)

302" & 351-W" V8 ENGINES (Cont.)

FRONT COVER OIL SEAL

Removal — Remove front cover following procedure given in Front Cover Removal. Using suitable pin punch, drive out old seal taking care not to damage seal surface.

Installation — Coat seal with grease and drive into front cover using suitable tool (T58P-6700-B or equivalent). Check seal to make sure that edges are fully seated and spring is properly positioned in seal. Reassemble in reverse order of removal.

TIMING CHAIN

Removal & Installation — Crank engine until timing marks are positioned properly (see Fig. 14). Remove camshaft sprocket cap screw, washers and fuel pump eccentric. Slide both sprockets and timing chain forward off key ways and remove as an assembly. To install, position timing chain on sprockets with timing marks aligned. Slide timing chain and sprockets onto crankshaft and camshaft as an assembly. Install fuel pump eccentric, washers and sprocket cap screw. Tighten bolt and then oil timing chain.

| CAMSHAFT | | | |
|------------------|---------------|----------------|----------------------------|
| Engine | Journal Diam. | Clearance | Lobe Lift |
| 302" & 351-W" | No. 1 | 2.0805-2.0815" | Int. .2303" Exh. .2375" |
| | No. 2 | 2.0655-2.0665" | |
| | No. 3 | 2.0505-2.0515" | |
| | No. 4 | 2.0355-2.0365" | |
| | No. 5 | 2.0205-2.0215" | |

① — End play is .001-.007"

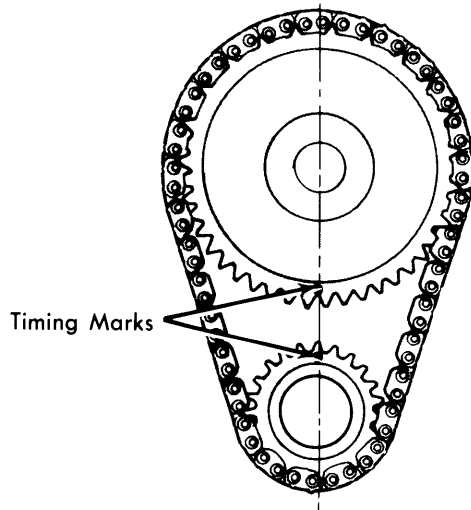

Fig. 14 Aligning Timing Marks

CAMSHAFT

Removal & Installation — Drain cooling system, remove radiator, engine front cover and related parts, and timing chain. Remove intake manifold and related parts. Remove valve covers and loosen rocker arms. Remove push rods and valve lifters in sequential order so as to return to original location. Remove thrust plate and carefully pull camshaft out through front of engine. **CAUTION** — Do not scar or mark camshaft lobes or bearing journals while removing camshaft. Oil camshaft journals with engine oil and apply Lubriplate or equivalent to camshaft lobes. Carefully slide camshaft through cam bearings and install camshaft thrust plate. Reassemble engine in reverse of removal procedure.

CAMSHAFT BEARINGS

Removal & Installation — **NOTE** — Camshaft bearings are not interchangeable from one bore to another. Remove camshaft, flywheel, and crankshaft. Push pistons to top of cylinders. Remove camshaft rear bearing bore plug and remove camshaft bearings. Using suitable cam bearing installing tool, fit cam bearings into block assembly. Make sure oil holes are properly aligned in each journal. Be sure front bearing is installed to specific distance below front face of cylinder block, distance specified is .005-.020".

CAMSHAFT END THRUST

Rocker arm stud nuts or bolts must be loosened sufficiently to free load on camshaft. Push camshaft toward rear of engine and install dial indicator so that point of indicator is on camshaft sprocket attaching bolt. Zero dial indicator. Position screwdriver between camshaft sprocket or gear and front of

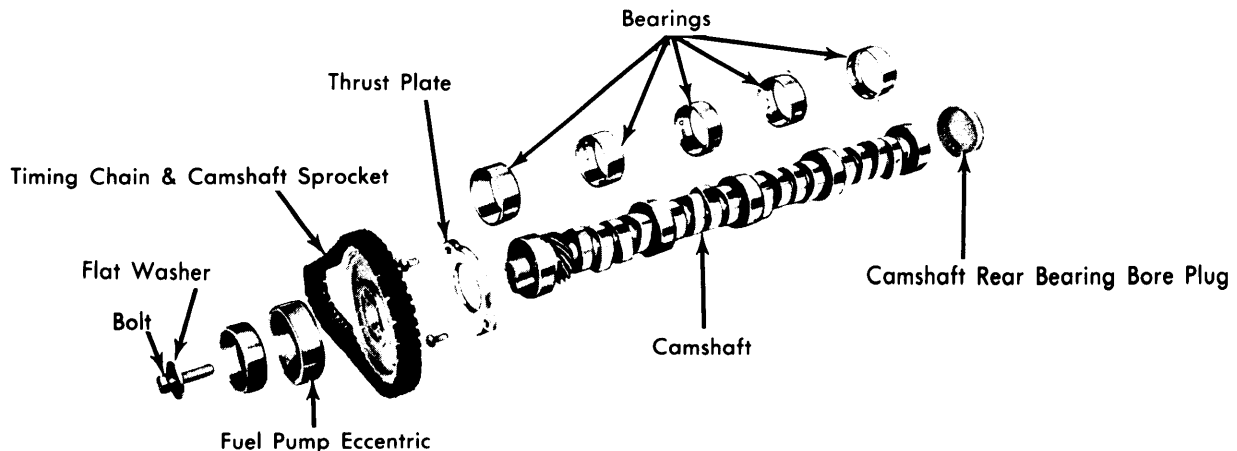

Fig. 15 Exploded View of Camshaft Assembly

302" & 351-W" V8 ENGINES (Cont.)

block. Pull camshaft forward and release, if end play is excessive, replace thrust plate. **CAUTION** — Do not attempt to pry camshaft back and forth in block with valve train load on camshaft.

CAM LOBE LIFT

Check lift of each camshaft lobe in consecutive order as follows:

- 1) Remove all rocker arms. Make sure each push rod is in valve lifter socket. Install dial indicator allowing ball socket adapter of dial indicator to rest on end of push rod in same plane as push rod movement.
- 2) Using remote starter switch (with ignition switch in "OFF" position), turn engine until valve lifter being checked is on base circle of camshaft lobe indicating lowest point of push rod travel.
- 3) Zero dial indicator and continue to rotate engine until push rod is in fully raised position giving highest indicator reading. Continue same procedure for each camshaft lobe. Compare camshaft lift from dial indicator readings with specifications.
- 4) To check accuracy of dial indicator readings, continue to rotate engine until dial indicator reads zero. If lift on any camshaft lobe is .005" less than specifications, valve lifters are operating on worn camshaft lobes, indicating need for camshaft replacement.

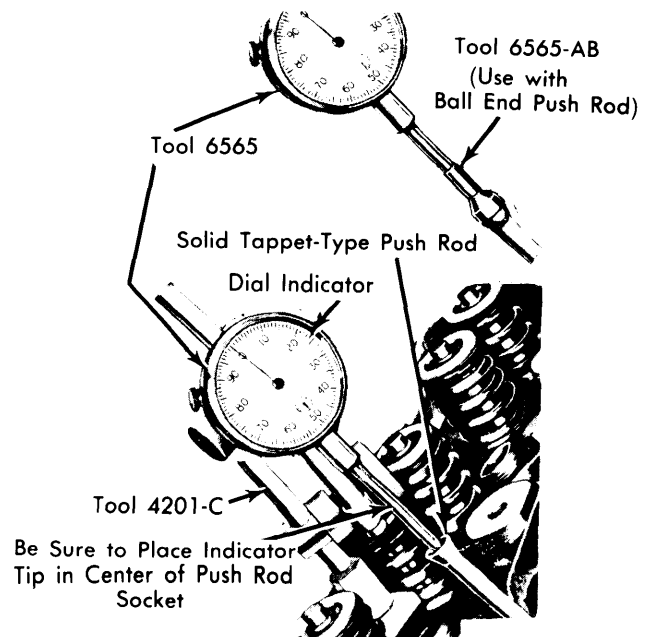

Fig. 16 Checking Camshaft Lobe Lift

ENGINE OILING

Crankcase Capacity — 302" & 351-W" engines require five quarts of oil. All engines require one extra quart of oil with filter change.

Oil Filter — Replace at first oil change and every second oil change following.

Normal Oil Pressure — 302" engines have 40-60 psi at 2000 RPM, 351-W" engines have 40-65 psi at 2000 RPM.

Pressure Regulator Valve — Housed in oil pump body on all engines. Not adjustable.

ENGINE OILING SYSTEM

System is pressure feed from rotor type oil pump in left forward section of engine. Oil flows through full flow oil filter before entering main oil gallery on right side of camshaft. Oil from main gallery enters main bearings through drilled passages in block, passes through main bearings up to camshaft bearings. Oil moves through secondary drilled passages from main bearings to lifter galleries, push rods pick oil up from lifters and through rotation of push rod moves oil up to top of head assembly to rocker arms. Oil is returned through drain holes in head assemblies back down into crankcase.

OIL PUMP

Removal & Disassembly — Remove oil pan, attaching bolts and oil pump from engine. Remove oil inlet tube, cover attaching screws, and cover. Remove inner rotor and shaft assembly, remove outer race. Drill small hole into oil pressure

relief spring valve chamber cap. Insert self-threading sheet metal screw into the cap and pull from chamber. Remove the spring and plunger.

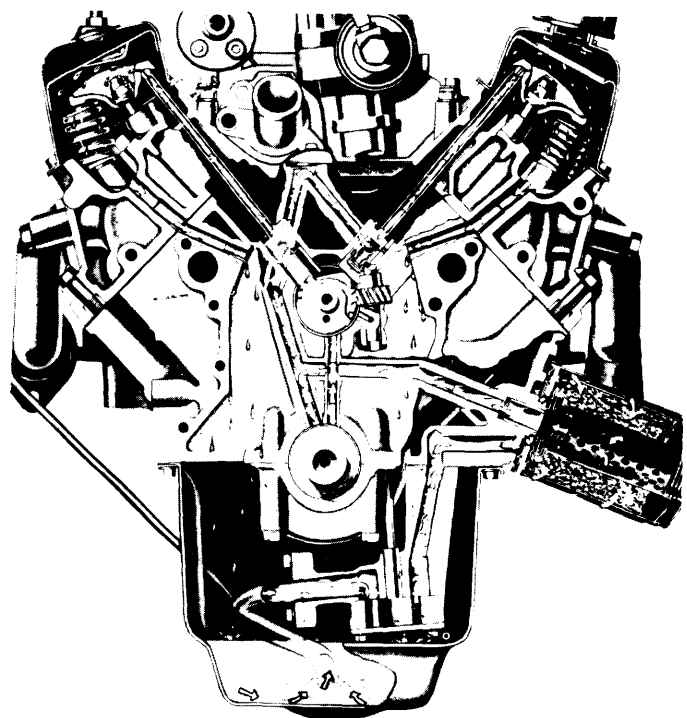

Fig. 17 Engine Oiling System

302" & 351-W" V8 ENGINES (Cont.)

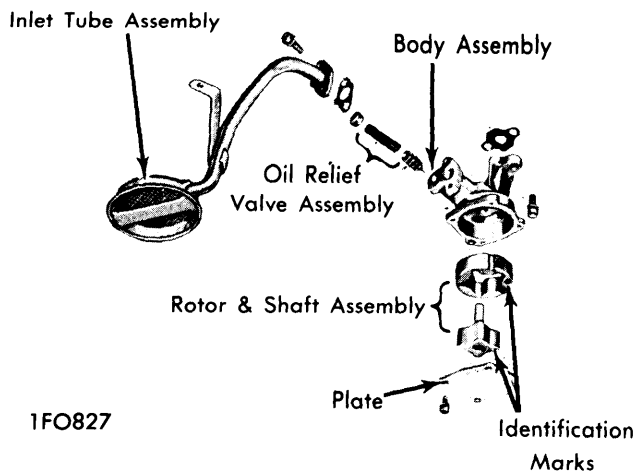

Fig. 18 Disassembled View of Oil Pump

Inspection and Reassembly — Clean, inspect, and oil all parts thoroughly. Install relief valve plunger, spring, and new cap. Stake cap into position. Install outer race and inner rotor and shaft assembly (see specifications for clearances). **NOTE** — Identification mark on rotor and on outer race must face outward and to same side. Install cover and tighten cover bolts. Position oil inlet tube on oil pump, install new gasket and tighten attaching bolts. Prime oil pump by submerging inlet port in oil and rotating shaft until oil flows from outer port.

Oil Pump Specifications

| | |
|---------------------------------------|-----------------------|
| Relief Valve Spring Tension | |
| 302" | 10.6-12.2 lbs.@1.704" |
| 351-W" | 18.2-20.2@2.49" |
| Shaft-to-Housing Clearance | .0015-.0029" |
| Relief Valve Clearance | .0015-.0029" |
| Rotor Assembly End Clearance | .001-.004" |
| Outer Race-to-Housing Clearance | .001-.013" |

TIGHTENING SPECIFICATIONS

| Application | Ft. Lbs. |
|------------------------------|----------|
| Cylinder Head | |
| Step One | 50 |
| Step Two | 60 |
| Step Three | 65-70 |
| Oil Pan ^① | 8-11 |
| Intake Manifold | 23-25 |
| Exhaust Manifold | 18-24 |
| Flywheel-to-Crankshaft | 75-85 |
| Main Bearing Caps | 60-70 |
| Connecting Rod Caps | 19-24 |
| Pulley-to-Damper | 35-50 |
| Rocker Arm Cover Bolts | 3-5 |
| Damper-to-Crankshaft | 70-90 |
| Camshaft Thrust Plate | 9-12 |
| Rocker Arm Stud Nut | 17-23 |
| Camshaft Sprocket | 40-45 |

① — 1/4 x 20 bolts require 7-9 ft. lbs.