

1973-74 455" V8 ENGINE

GENERAL SPECIFICATIONS							
Year	Displ. Cu. Ins.	Carburetor	HP at RPM	Torque (Ft. Lbs. at RPM)	Compr. Ratio	Bore	Stroke
1973-74	455"	4-Bbl.	8.5:1	4.126"4	4.250"

► **NET HORSEPOWER & TORQUE NOTE** — Horsepower and Torque figures given for 1972 and later are NET. NET Horsepower and Torque represent power at the flywheel when the engine is installed in the vehicle, with wide open throttle and all systems operating such as; air cleaner, exhaust system, water pump, generator, oil pump and air conditioning.

ENGINE IDENTIFICATION

Engine is identified by a code tape attached to engine oil filler tube directly above engine serial number.

Application **Code**
 455"VT

ENGINE REMOVAL

See *Engine Removal* at end of ENGINE Section.

INTAKE MANIFOLD

Removal-1) Disconnect negative battery cables from both batteries. Remove air cleaner, drain cooling system and disconnect upper radiator hose and by-pass hose from thermostat housing. Disconnect heater hose from rear of manifold.

2) If equipped with air conditioning, remove both upper fan shroud brackets. If not equipped with air conditioning, only left upper bracket must be removed. If equipped with 61 amp. alternator, alternator and brackets must be removed. If equipped with 80 amp. alternator, neither alternator or brackets must be removed.

3) Remove air conditioning compressor bracket but do not disconnect lines to compressor. Remove lower tube and elbow of oil filler tube. Disconnect temperature gauge wire. Disconnect throttle cable and cruise control rod (if equipped) from carburetor. Remove cruise control rod.

4) Remove fuel line from fuel pump to carburetor. Disconnect vacuum lines from distributor, tee in front of carburetor, brake booster, heater control and cruise control (if equipped). Pull crankcase ventilation valve from rubber grommet in right valve cover.

5) Disconnect spark plug wire from cylinders 2, 4, 6 and 8 (right bank), remove distributor cap from distributor and carefully position cap and cables to left side of engine, out of way. Remove coil mount bolts, leaving wires connected if desired. Remove manifold retaining bolts and lift off manifold with carburetor.

Installation — Make sure gasket surfaces on manifold and cylinder heads are clean. Apply sealer to both sides of new gaskets and position gaskets on cylinder heads. Carefully install intake manifold. Coat threads of manifold bolts with motor oil, install in manifold and tighten to 15 ft. lbs. in sequence shown in illustration. Retighten to 40 ft. lbs. in sequence shown in illustration. To complete installation, reverse removal procedure.

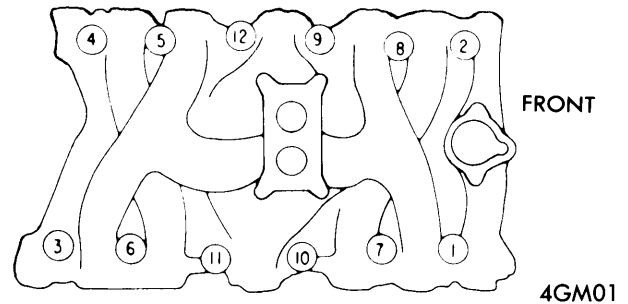

INTAKE MANIFOLD TIGHTENING SEQUENCE

CYLINDER HEAD

Removal — 1) Drain cooling system by opening radiator drain cock on radiator and raising rear of vehicle approximately 2½ feet. Remove intake manifold as previously outlined. Loosen exhaust pipe clamp at muffler, remove exhaust manifold bolts and position exhaust manifold away from cylinder head.

2) Remove valve cover, rocker arm pivot bolts, pivots, rocker arms and push rods. Mark or identify all components to ensure that they are installed in original position. Remove cylinder head retaining bolts and remove cylinder head.

Installation — Make sure gasket surfaces on head and cylinder block, bolt threads and threads in block are clean. Coat new gasket with sealer and place gasket on cylinder block. Carefully install cylinder head, dip head bolts in motor oil and install in cylinder head. Tighten cylinder head bolts to 60 ft. lbs. in sequence shown in illustration, then retighten to 85 ft. lbs. in sequence shown in illustration. To complete installation, reverse removal procedure.

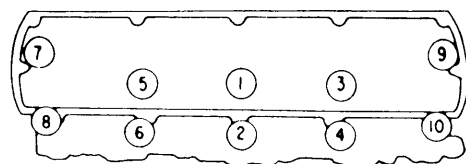

CYLINDER HEAD TIGHTENING SEQUENCE

1973-74 455" V8 ENGINE (Cont.)

VALVES							
Engine & Valve	Head Diam.	Face Angle	Seat Angle	Seat Width	Stem Diameter	Stem Clearance	Valve Lift
1973-74 455" Int.	1.990-2.000"	44°	45°	.037-.075"	.3425-.3432"	.0010-.0027"
455" Exh.	1.617-1.627"	30°	31°	.050-.090"	.3420-.3427"	.0015-.0032"

VALVE ARRANGEMENT

I-E-I-E-E-I-E-I (Both banks, front to rear.)

VALVE GUIDE SERVICING

If valve stem to guide clearance is excessive, valves with over-size stems are available. Valves are available with stems .003", .005", .010" and .013" oversize. Use a suitable reamer to ream guide for correct clearance for oversize valve stems.

VALVE STEM OIL SEALS

Umbrella type oil seals installed on valve stems. Seals are installed on valve stems with a suitable seal installation tool (J-24725). Check end of valve stem for nicks or burrs before installing seal.

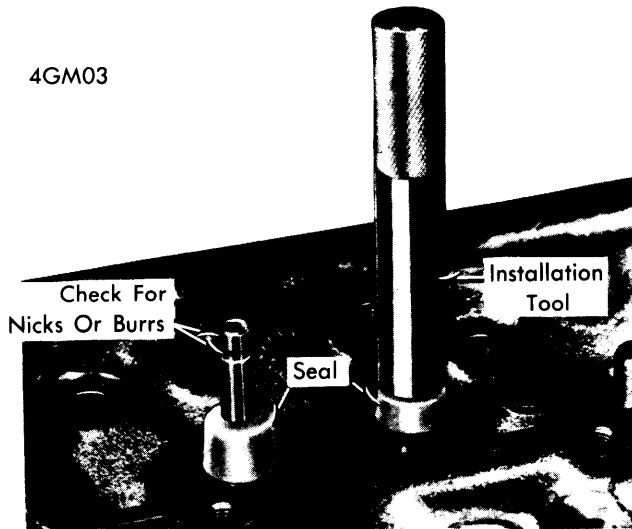

VALVE STEM OIL SEAL INSTALLATION

Installation — Check spring for squareness with a straightedge. If spring is off square more than $\frac{1}{16}$ ", spring must be replaced. Install seal on valve stem. See *Valve Stem Oil Seals*. Reverse removal procedure to install valve springs.

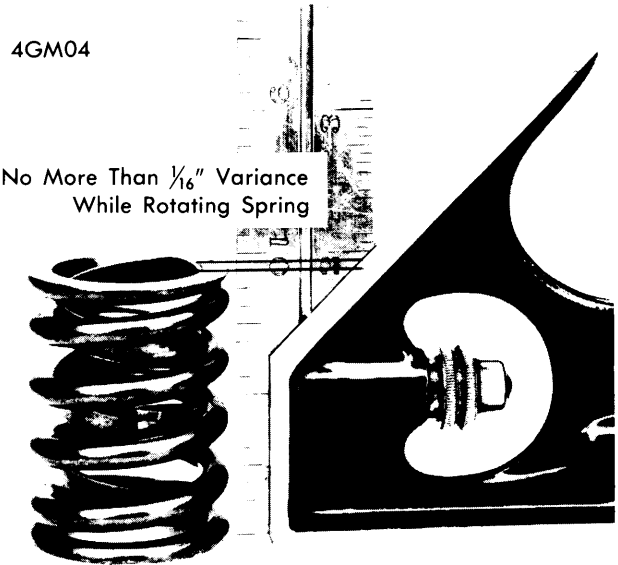

CHECKING VALVE SPRING SQUARENESS

ROCKER ARM ASSEMBLY

With valve covers removed, remove rocker arm pivot bolts and remove pivots and rocker arms. Mark or identify rocker arms and pivots to ensure that they are installed in original positions. Inspect rocker arm pad for off center wear and replace as necessary. Inspect all components for wear or damage and replace as necessary.

HYDRAULIC VALVE LIFTER ASSEMBLY

Mark or identify lifter to bore in block to ensure lifter is installed in original position. A .010" oversize lifter may have been installed at factory. If a .010" oversize lifter was installed, it will be identified by an "O" etched in side of lifter. Lifter bore in cylinder block will be identified also if oversize lifter is installed.

Disassembly — With lifter removed, remove retainer ring with a small blade screwdriver. Remove push rod seat and oil metering valve. Remove plunger and spring. If plunger is stuck and cannot easily be removed, soak lifter in carburetor cleaner for approximately 5 minutes to free plunger. Remove ball check retainer from plunger and remove ball and spring.

VALVE SPRINGS			
Engine	Free Length	PRESSURE (LBS.)	
		Valve Closed	Valve Open
1973-74 455"	1.96"	76-84@1.62"	180-194@1.27"

VALVE SPRINGS

Removal — With cylinder head removed, compress valve spring with a suitable spring compressor. Remove valve keepers, release spring compressor. Remove valve rotators, springs and spring seats.

1973-74 455" V8 ENGINE (Cont.)

Inspection — Clean all components in a suitable cleaner. Inspect all components for wear, nicks or burrs. If any components are defective, complete lifter must be replaced. Place a straightedge across foot of lifter. If straightedge shows lifter foot is flat or concaved, lifter must be replaced and camshaft lobes checked for wear. See *Camshaft*.

Assembly — Install ball check spring and retainer in plunger. Install plunger spring on ball check retainer. Hold plunger vertically to prevent cocking spring. Install oil metering valve and push rod seat. Place retaining ring in groove.

replace as necessary. Noise may be caused by other components other than lifters. Excessive wear on valve stem tips, rocker arm pads, push rods or valve springs may cause noise.

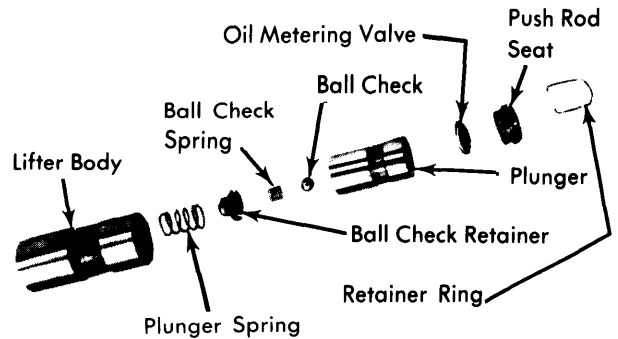

4GM05

HYDRAULIC VALVE LIFTER ASSEMBLY

HYDRAULIC VALVE LIFTER ADJUSTMENT

Lifters are nonadjustable, if noise in valve train components is evident, inspect all components for wear or damage and

PISTONS, PINS, RINGS						
Engine	PISTONS	PINS		RINGS		
	Clearance	Piston Fit	Rod Fit	Rings	End Gap	Side Clearance
1973-74 445"	.001-.002	.0003-.0005"	Ⓢ .0008-.0018"	1	.010-.023"	.002-.004"
				2	.010-.023"	.002-.004"
				3	.015-.055"	.002-.008"

Ⓢ — Interference fit.

OIL PAN

See *Oil Pan Removal at end of ENGINE Section*.

PISTON & ROD ASSEMBLY

Removal — Remove intake manifold, cylinder head and oil pan as previously outlined. Remove oil pump. Inspect top of cylinder bore for excessive ridge and remove with a suitable ridge reamer if ridge exists. Stamp or mark rod and rod cap for reinstallation. Mark piston and cylinder bore to ensure piston is installed in original position. Remove rod bearing cap and bearing. Install guide tube on connecting rod bolts and push piston and rod assembly up and out of cylinder bore to remove.

Installation — Install guide tubes on rod bolts. Position bearing inserts in rod and rod cap. Apply oil to rings and compress rings with a suitable ring compressor. Install respective piston in bore so that notch in top of piston is toward front of engine. Lubricate crankshaft journal and push piston and rod assembly into bore until bearing is aligned on journal. Install rod cap, matching identification numbers, making sure bearing tangs are on same side. Tighten rod nuts. Install remaining components as previously outlined.

FITTING PISTONS

1) Pistons are selective fit from factory. Size is designated by a letter code stamped in cylinder head mating surface adjacent to corresponding cylinder bore. If a piston is replaced, replacement piston must have same letter code.

2) If correct fit could not be obtained at factory, .010" over-size pistons are fitted to engine. These pistons are also selective fit and fit is designated by a letter code stamped in cylinder head mating surface adjacent to cylinder.

3) Check piston for taper or out-of-round conditions by measuring piston diameter at right angles to piston pin hole and 1/2" below hole. If piston tapers or is out-of-round more than .001", piston must be replaced.

4) Check cylinder bore for taper or out-of-round conditions with a micrometer or cylinder gauge. Cylinder bore should not taper or be out-of-round more than .001". If cylinder walls are scored, cylinders should be honed before installing new rings. If cylinders are honed, they must be thoroughly washed with soapy water before installing pistons.

5) Piston to cylinder clearance can be checked with a feeler gauge and a spring tension gauge. Place piston, with pin and rings removed, upside down in cylinder bore with a .0015" feeler gauge between piston and cylinder wall. If clearance is correct, 3 to 12 pounds should be required to pull feeler gauge out.

1973-74 455" V8 ENGINE (Cont.)

Piston & Bore Code Size

Application	Piston	Bore
Standard Bore		
Code "A"	4.1235-4.1240"	4.1250-4.1255"
Code "B"	4.1240-4.1245"	4.1255-4.1260"
Code "C"	4.1245-4.1250"	4.1260-4.1265"
Code "D"	4.1250-4.1255"	4.1265-4.1270"
Oversize (.010") Bore		
Code "J"	4.1335-4.1340"	4.1350-4.1355"
Code "K"	4.1340-4.1345"	4.1355-4.1360"
Code "L"	4.1345-4.1350"	4.1360-4.1365"
Code "M"	4.1350-4.1355"	4.1365-4.1370"

6) Check ring end gap in cylinder bore with a feeler gauge. Make sure ring is square in bore and at bottom of ring travel. Check ring side clearance in ring groove in piston with a feeler gauge. Make sure ring grooves in piston are clean.

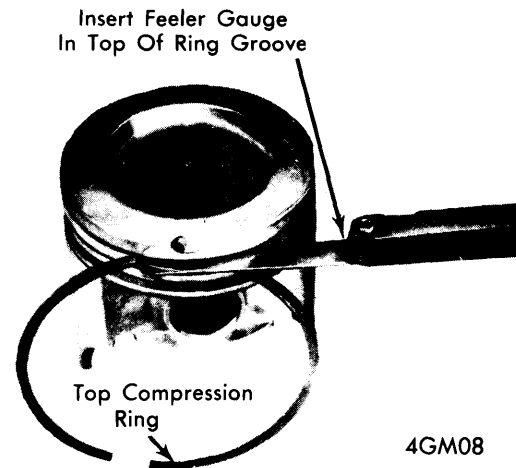

CHECKING RING SIDE CLEARANCE

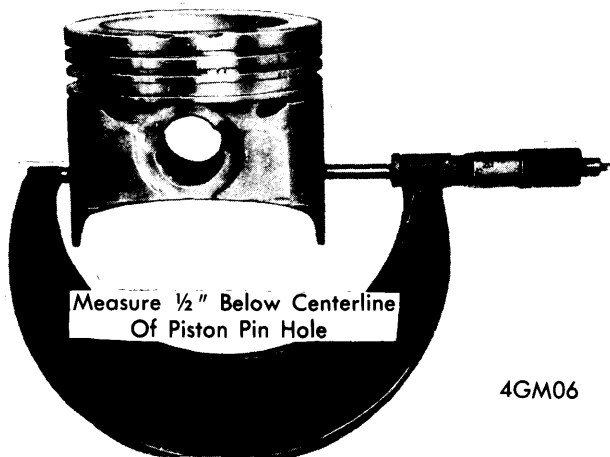

MEASURING PISTON

PISTON PIN

1) Piston pin is press fit in connecting rod and must be pressed out using suitable mandrels, support and an arbor press. Place piston on support with letter "F" or notch up and press out piston pin. Separate piston from connecting rod and clean all components.

2) Correct fit of pin in piston is .0003-.0005". If fit is .0003", pin will not fall through piston by its own weight but will push through under light hand pressure. If fit is .0005", pin will fall through by its own weight, but there should be no side clearance felt.

3) To assemble piston and connecting rod, oil all components. Place piston on support with letter "F" or notch up. Position rod in piston, aligning pin holes and press in piston pin. Connecting rod can be positioned in piston either way.

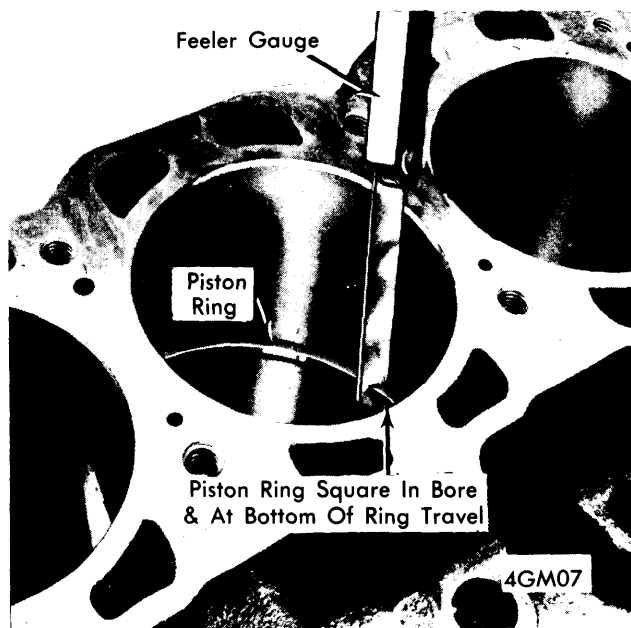

CHECKING RING END GAP

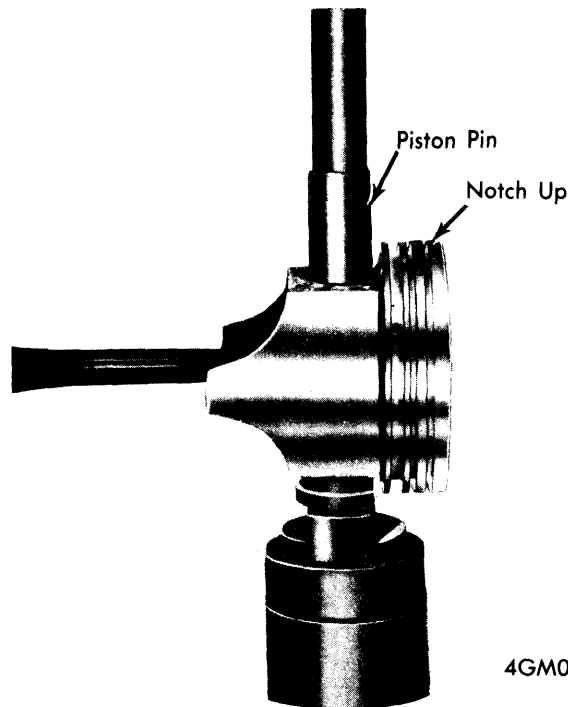

REMOVING PISTON PIN

1973-74 455" V8 ENGINE (Cont.)

CRANKSHAFT MAIN & CONNECTING ROD BEARINGS							
Engine	MAIN BEARINGS				CONNECTING ROD BEARINGS		
	Journal Diam.	Clearance	Thrust Bearing	Crankshaft Endplay	Journal Diam.	Clearance	Sideplay
1973-74 445"	2.9993-3.0003"	① .0005-.0021" ② .002-.0034"	No.3	.004-.008"	2.4988-2.4998"	.0004-.0033"	.006-.020"

- ① - Journal Nos. 1, 2, 3 & 4.
- ② - Journal No. 5.

MAIN & CONNECTING ROD BEARINGS

Connecting Rod Bearings - 1) Remove oil pan as previously outlined. Oil pump must be removed to gain access to rear connecting rod bearings. Rotate crankshaft until rod journal is at bottom and stamp identification numbers in machined surface in side of rod and cap for correct installation. Remove rod nuts and rod cap. Push up on connecting rod and remove bearing insert.

2) Inspect journals for roughness or scoring. Slight roughness may be removed with a fine grit polishing cloth and motor oil. Check crankshaft journal to bearing clearance using the Plastigage method. Check journal for out-of-round conditions with a micrometer. If crankshaft journal is severely scored or if clearance exceeds .0035", or if crankshaft is out-of-round more than .0015", crankshaft must be replaced.

3) Make sure bearing surface in rod and rod cap is clean and place bearing inserts in position aligning bearing tang in notch. Lubricate crankshaft journal and pull down on connecting rod, aligning bearing on journal. Install rod cap and tighten nuts. Check rod side clearance by prying rods apart with a screwdriver and measuring clearance with a feeler gauge.

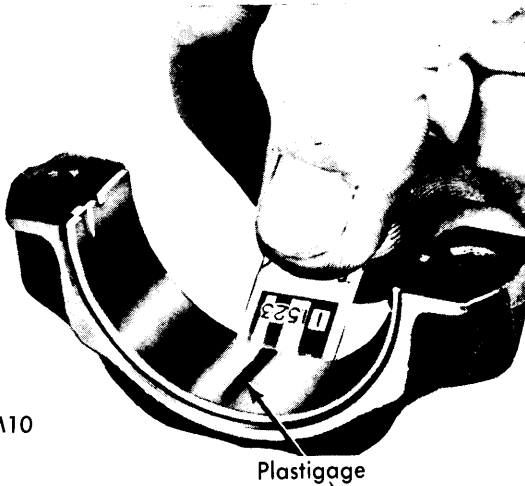

CHECKING CLEARANCE USING PLASTIGAGE METHOD

Main Bearings - 1) Main bearings are selective fit from factory. Undersize bearings may be installed at factory to obtain correct clearance with main bearing journal. Size of bearing is designated by a letter code on bearing tang. A standard bearing will not have a letter code.

Main Bearing Undersize Code

Application	Size
Letter Code "A"	0005" Undersize
Letter Code "B"	0010" Undersize
Letter Code "C"	0015" Undersize

2) Mark or identify main bearing caps to ensure that they are installed in original position. Remove main bearing cap bolts and remove main bearing caps. Remove upper bearing insert by installing a suitable bearing removal and installation tool in oil hole in crankshaft journal and rotating crankshaft in opposite direction of regular rotation.

3) Check crankshaft main journals for taper or out-of-round conditions with a caliper or a micrometer. If journal tapers or is out-of-round more than .0015", crankshaft must be replaced. Check crankshaft to bearing clearance using the Plastigage method. If clearance exceeds .0035", replace both bearings. If correct clearance still can not be obtained, crankshaft must be replaced.

4) Clean all crankshaft journals and main bearing caps before bearing installation. Apply a suitable lubricant (Lubricant No. 1050169) to thrust bearing flanges on thrust bearing. Use same procedure as described in bearing removal to install new upper bearing insert. Install new bearing in cap, install caps in original position and tighten bolts.

THRUST BEARING ALIGNMENT

Crankshaft end play is controlled by thrust bearing, mounted in number 3 main bearing journal. Check crankshaft end play with a feeler gauge. If end play exceeds specifications, replace thrust bearing.

REAR MAIN BEARING OIL SEAL

If rear main bearing oil seal leaks, seal can be repaired without removing crankshaft. If upper seal must be replaced, crankshaft must be removed.

Seal Repair - 1) Remove oil pan as previously outlined. Remove oil pump and rear main bearing cap. Using a suitable packing tool (J-2156-2), gently pack seal into groove 1/4" to 3/4" further. Repeat same procedure on other side of seal.

2) Measure amount seal is packed into groove. Add 1/6" to this amount and cut an equal amount off of seal removed from main bearing cap. Repeat procedure to obtain a length of seal for other side. Work both these pieces into seal groove using two small blade screwdrivers and a suitable guide tool (J-21526-1) bolts to main bearing cap mounting surface on cylinder block. Use packing tool to pack these pieces into groove.

1973-74 455" V8 ENGINE (Cont.)

3) Place a piece of shim stock between seal and seal surface on crankshaft. Using a razor blade, cut off excess seal. Install a new seal in rear main bearing cap. See *Seal Replacement*. Install rear main bearing cap and tighten bolts.

Seal Replacement — 1) Crankshaft must be removed to replace both halves of rear main oil seal. Remove seal halves and seat into position using a suitable tool (J-7588) and a hammer.

2) Cut off excess seal with a razor blade. Apply sealer to points shown in illustration. Lubricate seal and crankshaft. Install rear main bearing cap and tighten bolts.

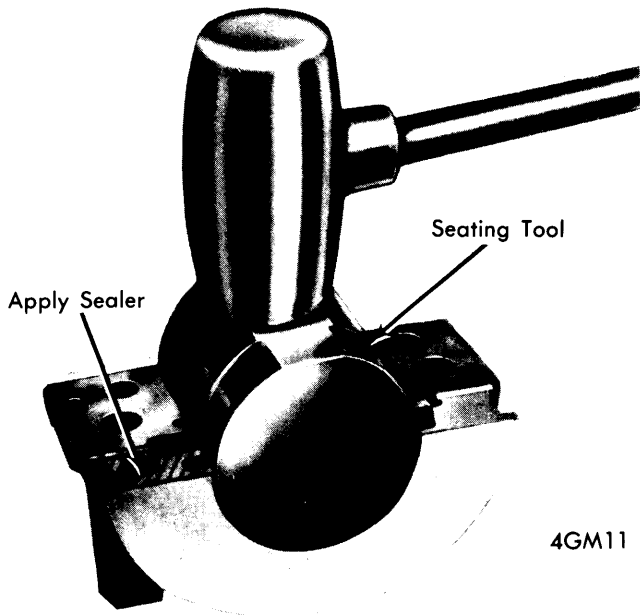

REAR MAIN OIL SEAL INSTALLATION

CRANKSHAFT PULLEY & HARMONIC BALANCER

Removal — Remove engine cover and raise vehicle. Loosen all drive belts and slip off of crankshaft pulley. Remove fan shroud seal retainer and push seal forward over shroud. Remove crankshaft pulley bolts and remove pulley. Remove harmonic balancer bolt and washer and pull off harmonic balancer with a suitable puller.

Installation — Apply sealer to inside diameter of harmonic balancer and lubricate seal contact surface on balancer shank. Install harmonic balancer with a suitable installation tool (J-24724). Install washer and bolt, and tighten bolt. To install remaining components, reverse removal procedure.

ENGINE FRONT COVER

Removal — Raise vehicle and drain cooling system. Disconnect radiator hoses, heater hose, and by-pass hose from water pump and radiator. Drain engine oil and remove crankshaft pulley and harmonic balancer as previously outlined. Remove clutch fan assembly and remove oil pan as previously outlined. Remove front engine cover retaining bolts and remove front engine cover.

Installation — Coat new front cover gasket with sealer and position gasket on cylinder block. Install engine front cover, oil threads on retaining bolts and install retaining bolts. Tighten bolts to specifications as shown in illustration. To install remaining components, reverse removal procedure.

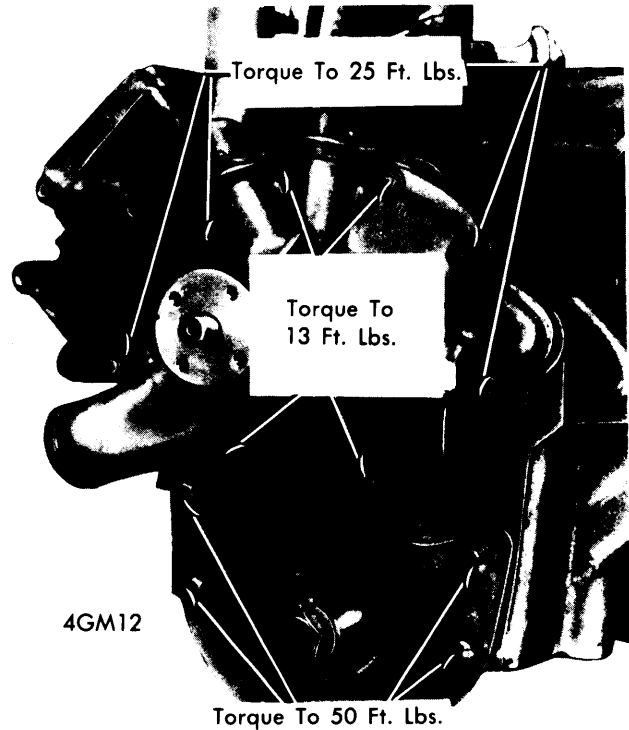

FRONT COVER BOLT TIGHTENING

FRONT COVER OIL SEAL

With Front Cover Installed — Remove crankshaft pulley and harmonic balancer as previously outlined. Pry out old seal with a screwdriver. Apply sealer to outside diameter of new seal. Using a suitable installation tool (J-5154), install seal into cover until a .005" feeler gauge will fit between front cover and installation tool. Install remaining components as previously outlined.

CAMSHAFT			
Engine	Journal Diam.	Clearance	Lobe Lift
1973-74 455"			
No.1	2.0357-2.0365"	.002-.0058"
No.2	2.0157-2.0165"		
No.3	1.9957-1.9965"		
No.4	1.9757-1.9765"		
No.5	1.9557-1.9565"		

TIMING CHAIN & SPROCKETS

Removal — Remove front engine cover as previously outlined. Rotate engine until timing marks on sprockets are aligned (see illustration). Remove bolt from center of camshaft and remove fuel pump eccentric, oil slinger, camshaft sprocket and

1973-74 455" V8 ENGINE (Cont.)

timing chain. Remove crankshaft pulley with a suitable puller. Remove key from sprocket and crankshaft before removing sprocket if possible.

Installation — Install crankshaft sprocket and key. Position timing chain on camshaft sprocket and fit into position on engine, making sure timing marks are aligned. To install remaining components, reverse removal procedure.

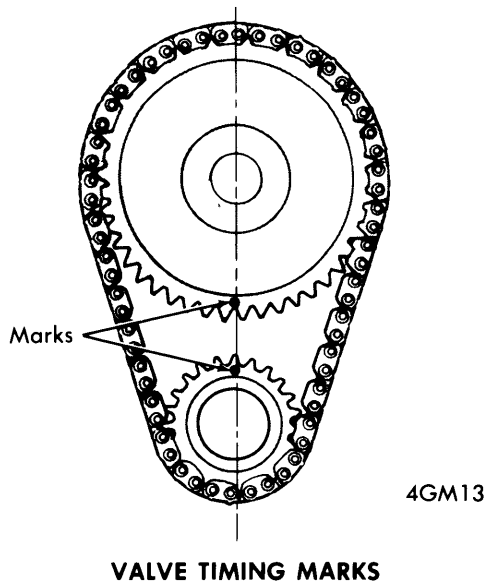

CAMSHAFT

Removal — Engine must be removed to remove camshaft. Remove oil pan, harmonic balancer, front engine cover and intake manifold as previously outlined. Remove rocker arms and withdraw push rods and lifter. Mark or identify rocker arms, push rods and lifters to ensure that they are installed in original position. Remove camshaft sprocket and timing chain as previously outlined. Pull camshaft carefully out toward front of engine to remove. Take care not to damage camshaft lobes or bearings.

Installation — Coat camshaft lubricant and slide into position into cylinder block. To install remaining components, reverse removal procedure. Make sure timing marks are aligned on sprockets.

CAMSHAFT BEARINGS

Removal — Bearings are replaced as a set. Number 1 bearing is removed first and remaining bearings removed in succession. Using a cam bearing removal and installation tool set, drive out number 1 bearing and remaining bearings in succession. When driving out number 5 bearing, drive out rear cam plug.

Installation — Coat outside diameter of rear cam plug with sealer and drive into position. To make sure oil holes in bearings are aligned with oil passages in block, place bearings in position with tapered edge of bearing against bore in block. Align oil hole in bearing with oil slot in block and mark bearing. Mark will act as guide when installing bearings. Install number 5 bearing first and remaining bearings in succession with number 1 bearing installed last.

ENGINE OILING

Crankcase Capacity — Capacity is 5 quarts, 6 quarts with filter change.

Oil Filter — Filter is replaced every 6,000 miles or more often under dusty or severe conditions.

Normal Oil Pressure — Oil pressure at normal idle should be no less than 7 psi. Oil pressure with engine at 1500-3000 RPM should be no less than 35 psi.

Pressure Regulator Valve — Located in oil pump body, non-adjustable.

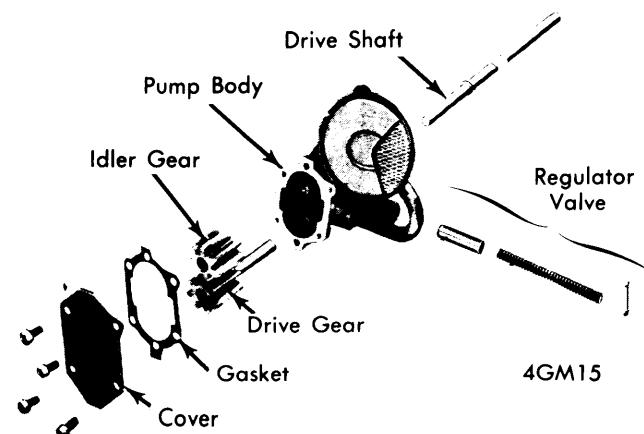

OIL PUMP

ENGINE OILING SYSTEM

Oil pump, driven by camshaft, provides full pressure lubrication to all camshaft, crankshaft and connecting rod bearings. Full pressure lubrication is also provided to valve lifters, push rods and rocker arms. Cylinder walls and piston pins are lubricated by splash oil from connecting rod journals.

OIL PUMP

Disassembly — With oil pump removed, remove pump drive shaft. Remove cotter pin, spring and pressure regulator valve. Remove cover, gasket and both gears.

General Motors V8 Engines

1973-74 455" V8 ENGINE (Cont.)

ENGINE OILING (Cont.)

Inspection — Thoroughly clean all components. Inspect gears for wear or damage and replace as necessary. Check gear end play and replace gears or pump body if end play exceeds .0065". Check pressure regulator valve components for wear or damage. Replace valve or pump body if clearance between valve and body exceeds .005".

Reassembly — Install drive gear in pump with hex mark toward oil pump mounting pad and install idler gear. Install cover with new gasket and tighten screws. Install regulator valve in body, closed end first. Install spring and cotter pin. Install drive shaft and check pump gears for freedom of movement.

1. Oil Pick-Up
2. Lifter Feed
3. Rocker Arm Valve Tip Feed
4. Splash Lube For Timing Chain And Fuel Pump Cam
5. Left Main Gallery Feed
6. Cam Bearing Feed
7. Main Bearing Feed
8. Rod Bearing Feed
9. Right Main Gallery
10. Distributor and Oil Pump Drive
11. Left Main Gallery
12. Oil Pump

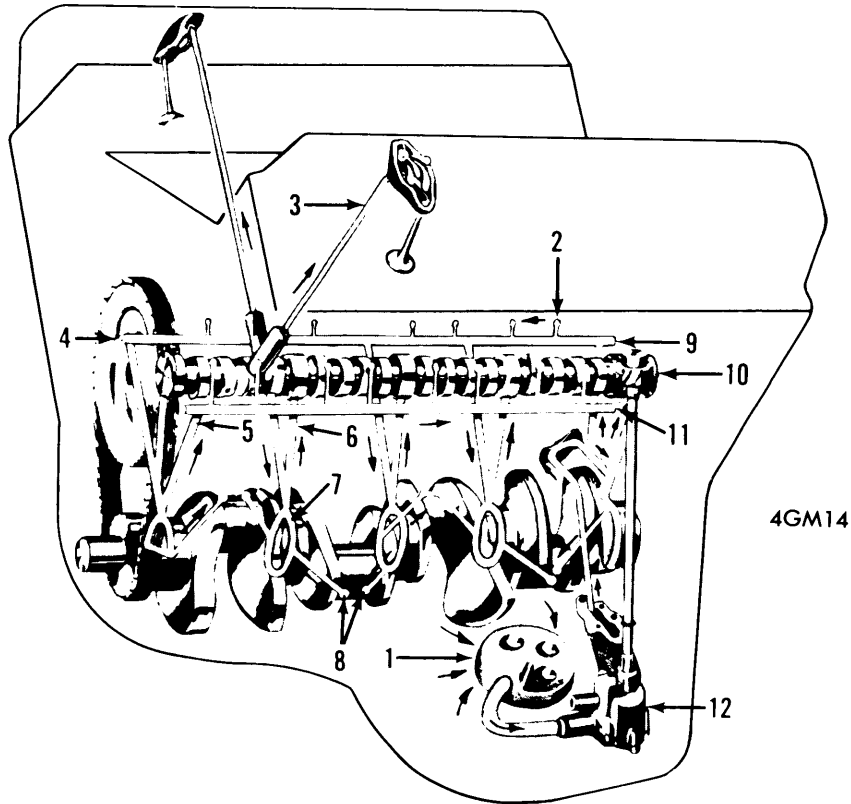

ENGINE OILING SYSTEM

TIGHTENING SPECIFICATIONS

Application	Ft. Lbs.
Cylinder Head Bolts.....	①
Intake Manifold Bolts.....	②
Exhaust Manifold.....	25
Main Bearing Cap Bolts.....	120
Connecting Rod Cap Nuts.....	42
Harmonic Balancer Bolts.....	160
Oil Pump Mount.....	35
Engine Front Cover.....	③
Rocker Arm Pivot Bolts.....	25
Fuel Pump Eccentric To Camshaft.....	65

- ① — See Cylinder Head.
- ② — See Intake Manifold.
- ③ — See Engine Front Cover.