

3K-C 4 CYLINDER

ENGINE CODING

ENGINE IDENTIFICATION

Engine serial number and code is stamped on right side of block above oil filter. First series of digits (3K) indicates engine code.

Application	Code
Corolla 1200 (1166 cc)	3K-C

ENGINE, CYLINDER HEAD & MANIFOLDS

NOTE — Following general procedures may not apply to all vehicles with 3K-C engine installed.

ENGINE

Removal — 1) Disconnect and remove battery. Drain cooling system and remove radiator with cooling fan assembly. Hood may be removed to provide greater access to engine and increased clearance when removing engine. Remove air cleaner and disconnect carburetor linkage. Disconnect fuel line at pump.

2) Disconnect exhaust pipe from manifold. Disconnect all engine-to-chassis electrical connections at engine. Remove drive shaft and insert suitable plug in rear of transmission to prevent fluid loss. Disconnect transmission linkage, wiring and speedometer cable.

3) Attach suitable hoist to engine hangers. Support transmission and remove crossmember. With hoist supporting engine, remove engine mounting bolts and/or nuts. Lift engine and transmission assembly up and out toward front of vehicle.

Installation — To install, reverse removal procedure, assuring that all fluid levels and adjustments are checked prior to starting engine.

MANIFOLDS

NOTE — Aluminum intake and cast iron exhaust manifolds are removed as an assembly.

Removal — Remove air cleaner. Disconnect fuel and vacuum lines at carburetor. Disconnect choke and throttle linkage at carburetor. Remove heat insulator, PCV valve and PCV hose. Disconnect exhaust pipe at manifold. Remove manifold retaining nuts and bolts and take off manifold.

Installation — To install, reverse removal procedure, ensuring that mating surfaces are clean and new gaskets are used. Front engine hanger is installed on top front stud between intake and exhaust manifold. Tighten 2 center bolts first, then top front, bottom rear, bottom front and top rear in that order.

CYLINDER HEAD

Removal — 1) Drain cooling system and remove upper radiator hose. Remove manifold and carburetor assembly. See **MANIFOLDS** in this article. Disconnect heater hose at rear of head. Remove rocker arm cover.

2) Loosen rocker arm support bolts in 3 or 4 steps and remove shaft assembly. Remove push rods and keep in order for reassembly in original positions. Disconnect spark plug wires. Loosen and remove head bolts in 2 or 3 steps in the sequence shown in Fig. 1. Lift head from engine.

Installation — Ensure that mating surfaces are clean, then install new gasket with "front" side facing up. Continue assembly in reverse order of removal. Tighten head bolts gradually in 2 or 3 steps as shown in Fig. 1. Install push rods and rocker shaft assembly, then adjust valves.

NOTE — When installing rocker shaft assembly, assure that adjusting screws are backed off about 2 turns.

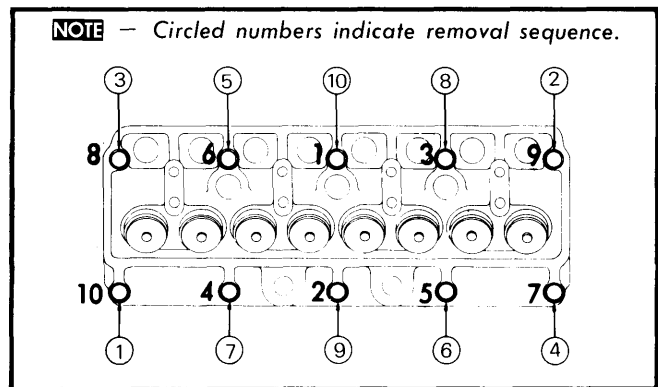

Fig. 1 Tighten Cylinder Head in Sequence Shown (Remove in Reverse Order ① Through ⑩)

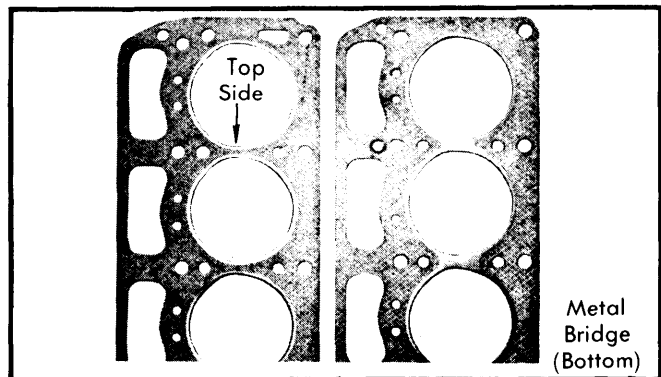

Fig. 2 Install Cylinder Head Gasket with Metal Bridge Down (Toward Block)

VALVES

VALVE ARRANGEMENT

E-I-I-E-E-I-I-E

VALVE GUIDE SERVICING

1) Measure valve guide inner diameter and valve stem outer diameter. If difference exceeds .003" (.08 mm) for intake or .004" (.10 mm) for exhaust valves, replace valves and/or guides.

NOTE — Cylinder head should be heated to about 212°F (100°C) before removal or replacement of valve guide.

3K-C 4 CYLINDER (Cont.)

2) To replace valve guide, break off upper portion of guide at snap ring. Drive remaining portion of guide out of head through combustion chamber with suitable driver (09201-60011).

3) Install snap ring on guide and install from top with driver. Drive in until snap ring contacts head. Guide projects .07" (1.8 mm) when properly installed. Ream guide for proper stem clearance.

NOTE — Oversize guides .002" (.05 mm) larger than original guides are available if required to obtain proper tightness between guide and head.

VALVE STEM OIL SEALS

Valve stem oil seal fits over guide and stem, under spring assembly.

VALVE SPRINGS

Removal — Use suitable compressor (09202-43011) to compress springs and retainers. Remove valve spring retainer locks (keepers), then remove retainer, spring, seal and washer. Mark and remove valves and components for reassembly.

Installation — Install components in original location and order. Use new seals on valve stems. Compress springs and install keepers.

NOTE — Some engines may have a spring shield under retainer and "O" ring seal on valve stem above keepers.

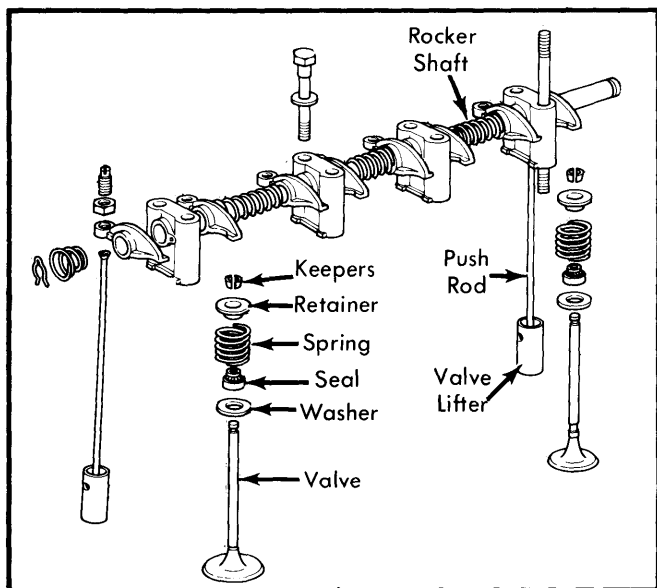

Fig. 3 View of Valve Train Components

VALVE SPRING INSTALLED HEIGHT

1) With valve spring removed, check length under specified load (see specifications) in a spring tester. Check valve spring free length, if less than 1.83", replace spring.

2) Check valve spring squareness with a steel square. If spring is out of square more than .063" (1.6 mm), replace spring.

ROCKER ARM ASSEMBLY

1) Remove valve cover and rocker arm assembly retaining bolts. Remove rocker arm assembly. Remove retaining clips from both ends of rocker arm shaft. Remove conical springs, rocker arms, springs and support stands.

2) Thoroughly clean and inspect all components. Check rocker arm-to-shaft clearance. If clearance exceeds .003", replace rocker arms or shafts as necessary. Reface valve end of rocker arm if worn. Lubricate all components before assembly.

3) Assemble rocker arm assembly in reverse of removal order. There are two types of rocker arms used, install rocker arm so that protruding side of valve end of rocker arm faces support stand. Install rocker stand so that when rocker assembly is installed, "F" mark on rocker stand faces front of engine.

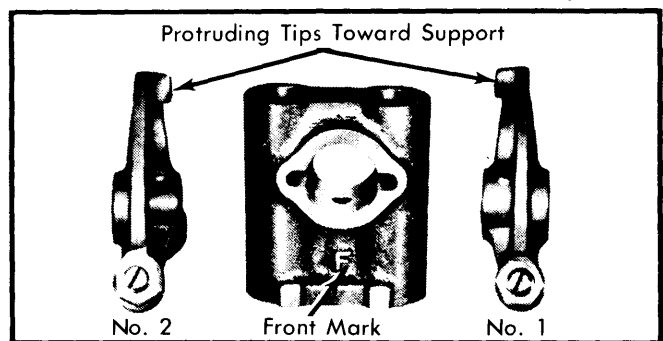

Fig. 4 Rocker Arms and Support Assembly Order

VALVE TAPPET SERVICE

1) Check clearance between valve tappet and tappet bore in crankcase. If clearance exceeds .004", replace tappet with oversize tappet and ream bore in crankcase to appropriate clearance.

2) Oversize tappet available is .002" over standard. Crankcase must be reamed .002" over standard or until correct clearance is obtained. Correct clearance is .0006-.0011".

VALVE CLEARANCE ADJUSTMENT

With number 1 cylinder at TDC on firing stroke, adjust clearance on valves number 1, 2, 3, and 5. Rotate crankshaft one revolution (360°) and set valves number 4, 6, 7, and 8. Set clearances COLD to: Intake — .005" (.13 mm), Exhaust — .009" (.23 mm). If setting HOT, use following clearances: Intake — .008" (.20 mm), Exhaust — .012" (.30 mm).

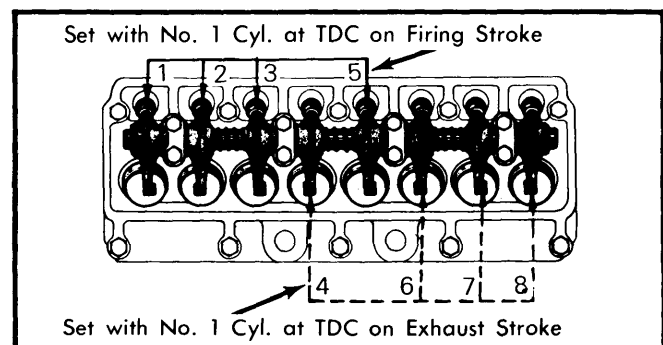

Fig. 5 Adjust Valve Clearance in Order Shown

3K-C 4 CYLINDER (Cont.)

PISTONS, PINS & RINGS

OIL PAN

NOTE — Engine must be removed to remove oil pan.

Removal & Installation — With engine out of vehicle, drain any remaining oil from pan. Remove pan retaining nuts and bolts and take off oil pan. Before installation, clean mating surfaces and apply sealer. Install pan with new gasket and tighten to specifications.

PISTON & ROD ASSEMBLY

Removal & Installation — 1) With engine out of vehicle, remove cylinder head and oil pan. Remove connecting rod cap with bearing half and push piston and connecting rod assembly up and out through top of block. Mark rod and cap to ensure installation in original position.

2) Mark piston to insure that it is installed in same cylinder. To install piston and rod assembly, make sure ring gaps are in correct position (see illustration). Coat piston and rings with oil.

3) Compress piston rings with a ring compressor and install piston and rod assembly in crankcase with notch in piston facing front of engine. Make sure bearings are properly seated in connecting rod and cap and apply oil to crankshaft journal.

4) Make sure bearing in connecting rod is properly seated against crankshaft journal. Install connecting rod cap in correct position and tighten nuts to specifications. Install cylinder head, oil pan and engine as previously outlined.

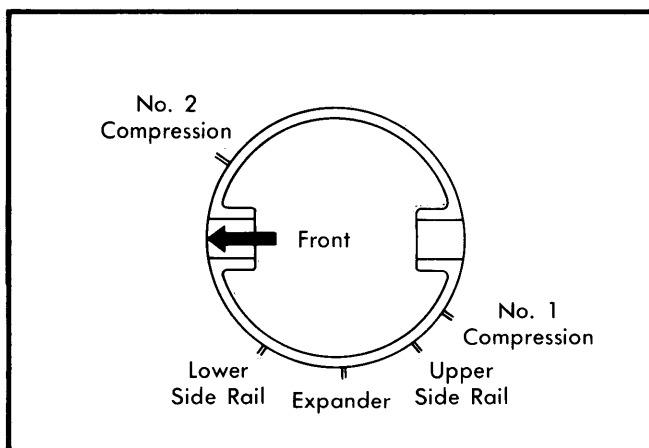

Fig. 6 Arrange Piston Ring Gaps as Shown

PISTON PIN REPLACEMENT

1) Remove circlips from pin hole in piston, heat piston to approximately 158-176°F and drive out piston pin. Make sure piston, pin and connecting rod are marked for assembly with each other.

2) Thoroughly clean and inspect all components. Piston pin should push fit through piston with piston heated to approximately 158-176°F. If pin falls through piston or fit is too loose, replace piston and pin.

3) Check piston pin-to-connecting rod clearance, if more than .002", bushing must be replaced. Press bushing out and install new bushing using a press and a suitable driver (09222-30010). With new bushing installed, ream to correct clearance with piston pin.

4) Thoroughly lubricate all components before assembly. Position piston on connecting rod with notch in piston facing in same direction as mark on lower part of connecting rod (see illustration). Heat piston to 158-176°F and install piston pin and circlips.

FITTING PISTONS

1) Measure cylinder bores in 3 places at 90° to and parallel with crankshaft. If more than .008" (.20 mm) over standard, cylinders must be rebored. Pistons and rings are available in .020", .030" and .040" (.50, .75 and 1.00 mm) oversize.

2) Measure diameter of piston .60" (15 mm) from bottom of skirt at 90° to piston pin. Standard diameter is 2.953-2.955" (75.00-75.05 mm). Normal clearance is .0012-.0020" (.03-.05 mm).

3) Check piston rings for wear or damage and replace as necessary. Check piston ring gap in cylinders and piston ring side clearance in pistons (see specifications). Install rings on pistons with marks on rings up and make sure ring grooves in pistons are clean.

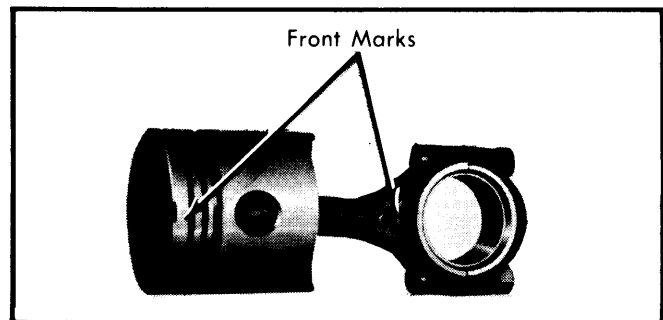

Fig. 7 Piston & Rod Assembly Markings

CRANKSHAFT MAIN & CONNECTING ROD BEARINGS

MAIN & CONNECTING ROD BEARING SERVICE

1) With engine mounted on suitable workstand, remove piston and rod assemblies as previously outlined. Remove crankshaft pulley bolt and take off crankshaft pulley with suitable puller (09213-31021). Remove timing chain cover and rear oil seal retainer. Remove camshaft sprocket and timing chain.

2) Remove oil pump. Remove main bearing caps with bearing halves and remove crankshaft. Crankshaft timing sprocket and pilot bearing in rear of crankshaft may be removed if desired.

3) Thoroughly clean and inspect crankshaft. Blow out all oil passages with compressed air. Check crankshaft for runout by

3K-C 4 CYLINDER (Cont.)

checking center main bearing journal with a dial indicator. If crankshaft exceeds runout limit of .002" (.04 mm), it must be replaced.

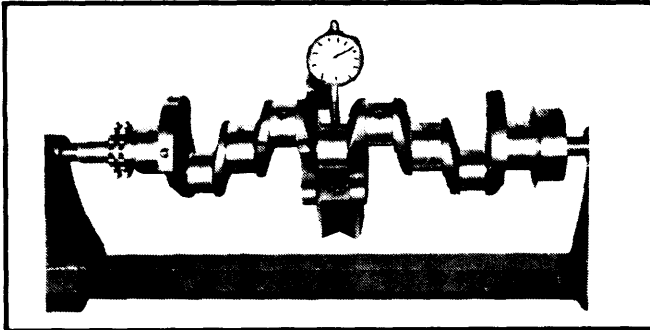

Fig. 8 Checking Crankshaft Runout at Center

4) Measure main and connecting rod journals. If limit of .0004" (.01 mm) out-of-round or wear is exceeded, crankshaft must be reground or replaced. Main bearings are available in .010" and .020" (.25 and .50 mm) undersize. Connecting rod bearings are available in .010", .020" and .030" (.25, .50 and .75 mm) undersizes.

5) Main and connecting rod bearing clearance is checked by the Plastigage method. To check connecting rod bearing clearance, make sure bearing halves and crankshaft journals are thoroughly clean. Place a piece of Plastigage wire on journal being checked. Install connecting rod cap and tighten nuts to specifications.

6) Remove connecting rod cap and check flattened wire against scale on back of Plastigage package to determine clearance. Main bearing clearance is checked in same manner. If rod bearing clearance is more than standard, a .002" (.05 mm) undersize bearing is available. If clearance is excessive with undersize bearing, crankshaft must be ground to next undersize. The limit of bearing clearance on both main and connecting rod bearings is .004" (.1 mm).

7) Check crankshaft end play with number 3 main bearing cap and original thrust washers installed. Pry crankshaft back and forth and measure clearance with a feeler gauge. Standard clearance is .002-.009" (.04-.22 mm) with a maximum limit of .012" (.3 mm). Excessive clearance may be reduced with washers .002" (.125 mm) or .004" (.250 mm) oversize. Install thrust washers with grooves toward crankshaft.

8) Install bearing halves in crankcase and main bearing caps. Lubricate bearings and install crankshaft. Install main bearing caps with arrows toward front and tighten cap bolts in 3, 2, 4, 5, 1 order.

NOTE — Tighten bolts in 2 or 3 steps, checking crankshaft turning resistance after each step.

9) Install remaining components in reverse order of removal, noting proper alignment of timing marks. See **TIMING CHAIN REPLACEMENT**.

CRANKSHAFT REAR OIL SEAL

Removal & Installation — With flywheel removed, unbolt and take off seal retainer. Drive old seal out of retainer from smooth side. Drive new seal into position with suitable tool (09250-10011). Coat seal lips with multi-purpose grease and install seal assembly.

ENGINE FRONT COVER OIL SEAL

Removal & Installation — Remove crankshaft pulley and pull out old seal with suitable puller (09308-10010). Install new seal with driver (09223-22010). Lubricate seal lips and install crankshaft pulley.

TIMING CHAIN REPLACEMENT

1) With timing chain installed on engine, attach a spring tension gauge to chain and pull out on chain with a pressure of 22 lbs. and check distance between chain tensioner plunger and tensioner body.

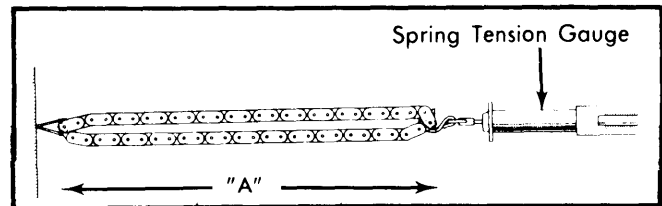

Fig. 9 Checking Timing Chain Elongation

2) If clearance exceeds .532", chain and sprockets must be removed and checked. Remove camshaft sprocket bolt and remove sprocket and chain. Pull crankshaft sprocket from crankshaft.

3) Secure one link of timing chain and attach spring tension gauge to opposite end (see illustration). With 11 lbs. tension applied to chain, distance "A" should be no more than 10.7". Replace chain if distance is more.

4) Place timing chain on crankshaft sprocket and measure diameter, if less than 2.34", replace sprocket. Measure camshaft sprocket in same manner, if less than 4.48", replace camshaft sprocket.

5) To correctly install sprockets and timing chain, install crankshaft sprocket with "O" mark in line with dowel pin on camshaft (see illustration). Place timing chain on sprocket with mark on chain aligned with mark on sprocket.

6) Align camshaft sprocket "O" mark with mark on timing chain and install camshaft sprocket on camshaft. Tighten camshaft sprocket bolt to specification. Install chain tensioner and vibration damper. Install timing chain cover as previously outlined.

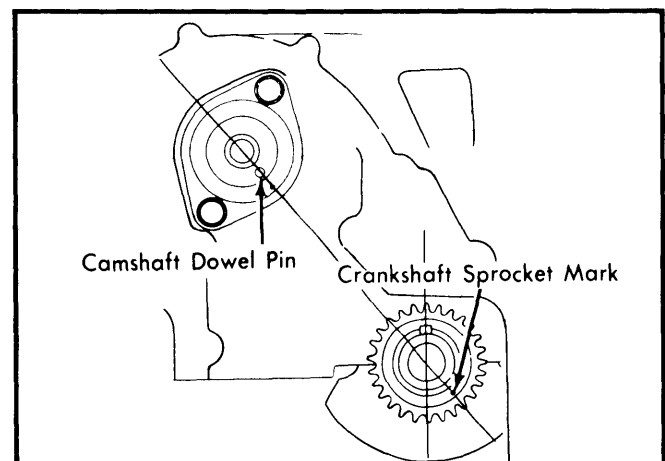

Fig. 10 Aligning Marks for Timing Chain & Sprocket Installation

3K-C 4 CYLINDER (Cont.)

TIMING CHAIN TENSIONER & DAMPER

1) Inspect surfaces of tensioner plunger and bore of tensioner body. To test clearance, lubricate plunger and insert it into plunger body. Cover two oil passages with fingers and pull plunger about half way out. Vacuum strong enough to return plunger should be felt.

2) Measure thickness of tensioner head and chain damper wall. Head should be minimum .47" (12 mm) and chain damper should be minimum .28" (7 mm).

CAMSHAFT**CAMSHAFT**

With camshaft sprocket and timing chain removed, take off camshaft thrust plate. Remove front end plate from engine block. Remove tappets (valve lifters) and distributor if not previously removed. Pull camshaft straight out, using care not to damage bearings or journals.

NOTE — A head bolt may be screwed into end of camshaft to provide gripping surface for removal.

Check camshaft runout at number 2 journal by using $\frac{1}{2}$ of the largest difference shown by dial indicator. Maximum runout limit is .0012" (.03 mm), and maximum journal out-of-round or taper is .0008" (.02 mm).

CAMSHAFT BEARINGS

Measure camshaft journal diameter and subtract from measured diameter of bearing bore to determine clearance. Bearings should be replaced if clearance exceeds .004" (.1 mm). Journals may be ground and .005" (.125 mm) or .010" (.250 mm) undersized bearings installed if necessary. To replace bearings, remove expansion plug from rear of engine. Use bearing replacement tool (09215-22010) to remove old bearings and insert new ones.

CAUTION — Oil holes in bearings must be aligned with oil holes in cylinder block. Install new expansion plug, coated with sealer, when all bearings have been installed.

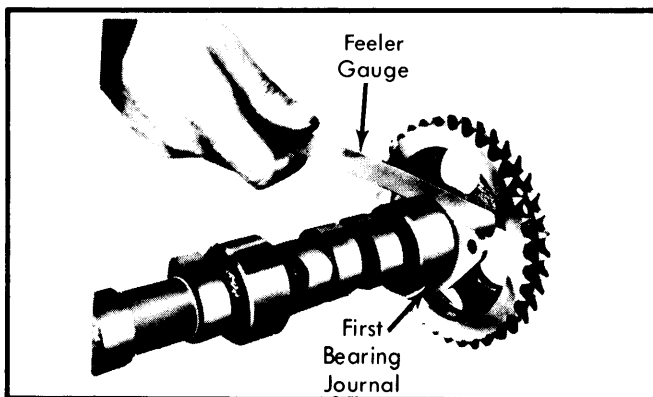

Fig. 11 Measure Camshaft Thrust Clearance with Camshaft Sprocket Installed

CAMSHAFT END THRUST

Check clearance between thrust plate and first bearing journal, if clearance exceeds .012", replace thrust plate.

NOTE — If clearance is still excessive after replacing thrust plate and installing sprocket, it will be necessary to replace the camshaft.

CAM LOBE LIFT

Total height of camshaft lobe is 1.436-1.440" (intake) and 1.432-1.436" (exhaust). Check total lobe height, if less than 1.424" (intake) and 1.420" (exhaust), replace camshaft.

ENGINE OILING

Crankcase Capacity — Approximately 3.5 quarts with filter.

Oil Filter — Full flow, mounted on outside of crankcase next to distributor.

Normal Oil Pressure — With engine at 212°F, 28.4 psi @ 300 RPM, 42.6 psi @ 3000 RPM.

Pressure Regulator Valve — Mounted in oil pump. See Oil Pump.

ENGINE OILING SYSTEM

Oil is circulated through the engine by pressure provided by a trochoid rotor type oil pump. Pump is mounted on bottom of crankcase and is driven by camshaft through the distributor drive. Oil is drawn from oil pan and is circulated through a full flow oil filter into the main oil gallery. Oil is then distributed to main and connecting rod bearing journals and camshaft bearings. Cylinders and piston pins are lubricated by oil squirting from hole in connecting rod. Oil is supplied to timing chain by oil from timing chain tensioner. Oil flows from number 2 cam bearing journal to rocker arm shaft to lubricate rocker arms. Excess oil from rocker arm shaft lubricates valves and valve stems.

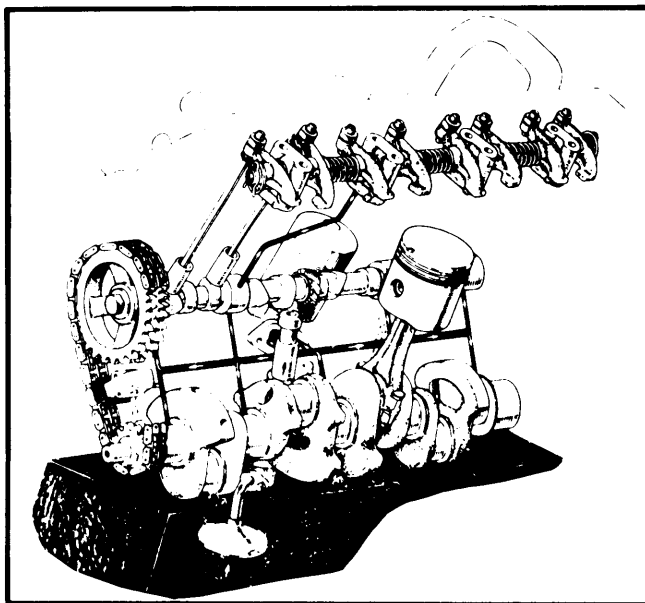

Fig. 12 Engine Oiling System

3K-C 4 CYLINDER (Cont.)

OIL PUMP

1) Remove oil pan as previously outlined and remove oil pump. Remove oil strainer, pump cover and pressure regulator plug from side of pump body. Remove spring, piston and rotors from pump body.

2) Thoroughly clean and inspect all components. Check rotor tip clearance, if more than .0079", replace rotors. Check clearance between drive rotor and cover. Place a straight edge on mating surface of pump body and insert a feeler gauge between straight edge and drive rotor. If clearance exceeds .0059", replace cover, pump body or rotors.

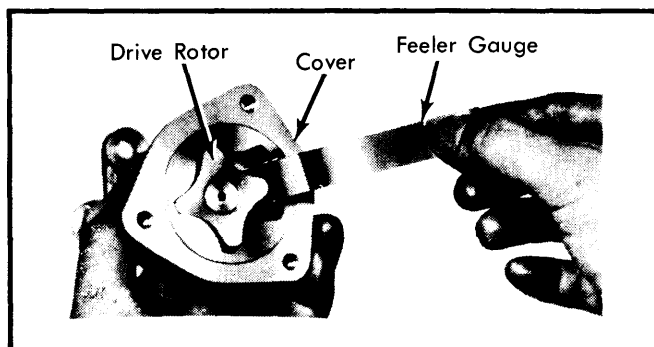

Fig. 13 Checking Oil Pump Rotor Tip Clearance

3) Check clearance between outer rotor and pump body with a feeler gauge. If clearance exceed .0079", replace pump body or rotors. Check pressure regulator spring and piston for wear or signs of seizure. Replace as necessary.

4) To assemble pump, reverse disassembly procedure. Install rotors with punch marks toward body (upward). With pump assembled, submerge in clean motor oil and rotate drive shaft

to check flow of oil from outlet port. Install pump and mounting bolt. Install oil pan.

Oil Pump Specifications

Application	In. (mm)
Rotor Tip Clearance002-.006 (.04-.16) Limit .008 (.2)
Rotor Side Clearance001-.004 (.03-.09) Limit .006 (.15)
Rotor-to-Body Clearance004-.006 (.10-.16) Limit .008 (.2)

ENGINE COOLING

Coolant Capacity – 5.8 quarts.

Thermostat – Begins to open as low as 177°F (80°C) and must be fully open at 212°F (100°C).

Radiator Cap – 13-15 psi.

WATER PUMP

Drain cooling system and loosen drive belt. Disconnect radiator and heater hoses at pump. Remove mounting bolts and take off water pump. Clean mating surfaces, coat new gasket with sealant and install water pump.

NOTE – Cooling fan is electrically driven and may run at any time the ignition is on if coolant temperature is high. It may be necessary to remove fan and shroud to provide greater access to the water pump.

ENGINE SPECIFICATIONS

GENERAL SPECIFICATIONS										
Year	Displ.		Carburetor	HP at RPM	Torque (Ft. Lbs. at RPM)	Compr. Ratio	Bore		Stroke	
	cu. ins.	cc					in.	mm	in.	mm
1979	71.1	1166	2-Bbl.	58@5800	63@3800	9.0-1	2.953	75	2.598	66

VALVES							
Engine & Valve	Head Diam. In. (mm)	Face Angle	Seat Angle	Seat Width In. (mm)	Stem Diameter In. (mm)	Stem Clearance In. (mm)	Valve Lift In. (mm)
3K-C Intake	45°	45°	.047-.063 (1.2-1.6)	.3136-.3140 (7.965-7.975)	.0014-.0026 (.035-.065)
Exhaust	45°	45°	.047-.063 (1.2-1.6)	.3134-.3140 (7.960-7.975)	.0016-.0028 (.040-.071)

Toyota Engines

3K-C 4 CYLINDER (Cont.)

ENGINE SPECIFICATIONS (Cont.)

PISTONS, PINS, RINGS						
Engine	PISTONS Clearance In. (mm)	PINS		RINGS		
		Piston Fit In. (mm)	Rod Fit In. (mm)	Rings	End Gap In. (mm)	Side Clearance In. (mm)
3K-C	.001-.002 (.03-.05)	①	.0002-.0003 (.004-.008)	No. 1	.004-.011 (.10-.28)	.0012-.0028 (.03-.04)
				No. 2	.004-.011 (.10-.28)	.0008-.0024 (.02-.06)
				Oil.	.008-.035 (.2-.9)

① — Push fit with piston and pin heated to 158-175°F.

CRANKSHAFT MAIN & CONNECTING ROD BEARINGS							
Engine	MAIN BEARINGS				CONNECTING ROD BEARINGS		
	Journal Diam. In. (mm)	Clearance In. (mm)	Thrust Bearing	Crankshaft End Play In. (mm)	Journal Diam. In. (mm)	Clearance In. (mm)	Side Play In. (mm)
3K-C	1.968-1.969 (49.976-50.000)	.0006-.0016 (.016-.040)	No. 3	.002-.009 (.04-.22)	1.653-1.654 (41.976-42.000)	.0009-.0019 (.024-.048)	.004-.008 (.11-.21)

VALVE SPRINGS			
Engine	Free Length In. (mm)	PRESSURE Lbs. @ In. (kg @ mm)	
		Valve Closed	Valve Open
3K-C	1.831 (46.5)	70.1@1.512 (31.8@38.4)

CAMSHAFT			
Engine	Journal Diam. In. (mm)	Clearance In. (mm)	Lobe Lift In. (mm)
3K-C Journal	No. 1	.001-.003 (.03-.07)
	No. 2		
	No. 3		
	No. 4		
	No. 4		

TIGHTENING SPECIFICATIONS	
Application	Ft. Lbs. (mkg)
Cylinder Head Bolts	39-48 (5.4-6.6)
Manifold Nuts	14-22 (2.0-3.0)
Main Bearing Cap Bolts	39-48 (5.4-6.6)
Connecting Rod Cap Nuts	29-38 (4.0-5.2)
Oil Pan Bolts	2-3 (.3-.4)
Camshaft Thrust Plate Bolts	4-7 (.6-.9)
Camshaft Sprocket Bolt	39-48 (5.4-6.6)
Crankshaft Pulley Bolt	33-40 (4.5-6.5)
Flywheel Bolts	39-48 (5.4-6.6)