

260 SERIES V6

GENERAL SPECIFICATIONS										
Year	Displ.		Carburetor	HP at RPM	Torque (Ft. Lbs. at RPM)	Compr. Ratio	Bore		Stroke	
	cu. ins.	cc					in.	mm	in.	mm
1976 B27F										
Federal	162.3	2660	F.I.	125@5500	150@2750	8.2-1	3.4646	88	2.8740	73
Calif.	162.3	2660	F.I.	121@5500	148@2750	8.2-1	3.4646	88	2.8740	73

ENGINE IDENTIFICATION

Engine type designation, part number, and manufacturing serial number are located on left side of cylinder block.

ENGINE REMOVAL

1) Remove gearshift lever (manual) or place lever in "Park" (automatic). Remove battery, hood, air cleaner and engine splash guard.

2) Drain cooling system (each side of block), and disconnect all coolant hoses. Disconnect automatic transmission oil cooler pipes at radiator. Remove radiator and fan shroud. Disconnect heater hose at intake pipe, power brake hose at intake manifold, and vacuum pump hose at pump. Remove vacuum pump.

3) Disconnect fuel hoses at filter and return pipe. Disconnect wiring harness and relay connectors. Remove high tension lead from distributor and heater hoses at fire wall. Disconnect carbon filter hose at filter, and hose from EGR valve. Remove connector at voltage regulator and wire clamp. Disconnect connector for distributor, throttle cable, vacuum amplifier hose at T-pipe, and wax thermostat hoses.

4) Remove hose from air pump to backfire valve and wires from solenoid valve and micro switch. Remove nuts from both exhaust manifold flanges. Remove A/C compressor and drive belt without disconnecting hoses. Drain engine oil. Remove power steering pump and belt.

5) Remove nuts from front engine mounts. Remove exhaust pipe clamps (front exhaust pipe with catalytic converter). Disconnect shift control lever at automatic transmission.

6) Disconnect slave cylinder from clutch (manual transmission) and detach speedometer cable. Disconnect propeller shaft. Put stands under front of car, and using wooden block, place jack under oil pan. Remove transmission attachment member.

7) Using safe hoisting equipment, lift engine from car.

NOTE - When removing engine, check for hoses and wires not previously removed.

CYLINDER HEAD (ENGINE IN VEHICLE)

Removal - 1) Disconnect battery ground cable. Remove air cleaner and disconnect throttle cable. Disconnect kick-down cable (automatic transmission) and remove pipe from EGR valve and intake manifold. Disconnect vacuum hose at EGR valve. Remove oil filler cap and stuff rag in filler hole. Disconnect crankcase ventilation pipe from intake manifold and remove intake manifold front, gaskets, and rubber rings.

2) Disconnect fuel line and connector from cold start injector. Disconnect vacuum hose, connector and two fuel lines from control pressure regulator. Disconnect hoses, pipes and electrical connectors, and remove auxiliary air valve. Remove connector at fuel distributor and wiring harness. Disconnect high tension leads from spark plugs and injectors from holders in both banks.

3) Disconnect vacuum hose at distributor, and remove vacuum, carbon filter, diverter valve, power brake, and heater hoses at intake manifold. Disconnect wires at throttle micro switch and solenoid valve, and fuel lines from filter and return pipe. Remove fuel distributor.

4) Disconnect EGR valve hose from throttle housing. Remove cold start injector and pipe. Remove intake manifold and rubber rings. Remove splash guard under engine and drain coolant from both sides of block. Remove air pump, vacuum pump and vacuum hoses at thermostat. Disconnect upper radiator hose and remove A/C compressor (do not remove hoses).

5) Remove distributor and EGR valve and bracket. Disconnect relay connectors and remove rear A/C bracket. Remove lower radiator hose at water pump and hoses from pump to cylinder heads. Disconnect supply hose from cylinder heads, and separate air manifold at rear of engine. Remove backfire valve and air hose. Remove valve covers.

6) On left side, remove four upper timing gear cover bolts and Allen head screw (not camshaft center bolt). On right side, remove four upper timing gear cover bolts and cover plate. Remove exhaust pipe clamps under vehicle and oil dipstick and pipe. Remove exhaust pipe flange and exhaust manifold. Remove cover plates at rear of cylinder heads.

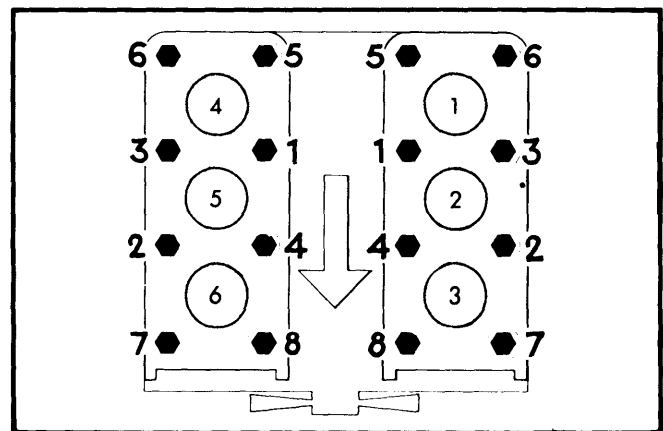

Fig. 1 Sequence for Removing and Installing Cylinder Head Bolts

260 SERIES V6 (Cont.)



Fig. 2 Special Tools for Removing Cylinder Heads

7) Rotate each camshaft until large hole in sprocket aligns with rocker arm shaft. Remove rocker arm and shaft assembly by removing bolts in sequence shown in Fig. 1. Loosen bolt and push camshaft lock fork to one side.

8) Install tool to hold camshaft sprocket in place (5104). With tool installed, remove camshaft center bolt and slide camshaft to rear. Be sure camshaft stud is free from sprocket.

NOTE — If tool is not used, camshaft chain will slacken and be held by chain tensioner. Sprocket then cannot be pulled upward when installing camshaft. If this should occur, timing gear cover must be removed for access to chain tensioner.

9) Insert two 12" long rods into cylinder head bolt holes, Fig. 2, and push downward to loosen cylinder head from block. Do not attempt to remove cylinder head by lifting straight upward. If liners are not to be removed, be sure they do not separate from their seals in lower liner seat. If seals are damaged, coolant will enter crankcase. Lift out cylinder head carefully.

10) Tap guide sleeves flush with block face and remove gasket. Install liner holders (5093) to secure liners against seat seals. Clean gasket surfaces and install camshaft retaining tool (5105). After tool is securely in place, remove fixing bolt from previously installed tool (5104). See Fig. 2.

NOTE — Sprocket retaining tool (5105) should be kept securely in place while cylinder heads are removed. This prevents camshaft chains from slackening, yet permits turning of crankshaft.

Installation — 1) Insert fixing bolt into camshaft sprocket retainer (5104) and remove other retainer (5105) from cylinder block face. Pull up on guide sleeves and insert a 1/8" drill bit under each sleeve. Remove liner holders (5093) and position cylinder head gasket on block face (left and right gaskets differ). Install cylinder head with one bolt and push camshaft into camshaft sprocket. Install camshaft center bolt, but do not torque. Remove drill bits from under guide sleeves

2) Position rocker arm and shaft assembly and install cylinder head bolts. Tighten all bolts in sequence shown in Fig. 1 in three stages:

Cylinder Head Tightening Specifications

Sequence	Ft. Lbs. (mkg)
Step One	7 (1.0)
Step Two	22 (3.0)
Step Three	⓪44 (6.1)

⓪ — After 10-15 minutes retorque with protractor (5098).

3) Torque camshaft center bolt and remove sprocket retainer (5104). Center lock fork over camshaft and tighten. Back off all cylinder head bolts in sequence, Fig. 1. Tighten to 11-14 ft. lbs. Using protractor (5098) on standard socket, torque head bolts as follows:

1. Use rocker arm and shaft as a guide line for protractor.
2. Fit socket over bolt 1 and take up slack of tool. Rotate protractor so that "0" mark aligns with rocker arm and shaft assembly.
3. Tighten bolt until protractor angle of 116-120° aligns with rocker arm guide line.
4. Repeat procedure in proper tightening sequence for other head bolts.
5. After engine is assembled, run at operating temperature for 15 minutes and cool for 30 minutes. Back off head bolts once more and torque to 11-14 ft. lbs. Then use protractor to torque bolts in sequence shown (Fig. 3) to 113-117°.

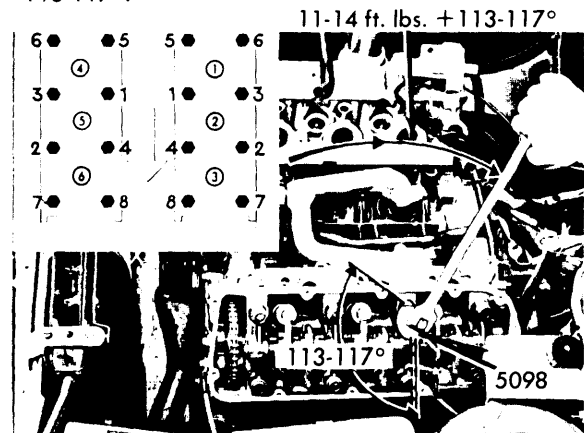

Fig. 3 Final Torquing of Cylinder Head Bolts After Running and Cooling Engine

260 SERIES V6 (Cont.)

4) Install remainder of components in reverse order of removal procedure, noting the following:

1. Before installing valve cover, adjust valves (cold setting).
2. When installing distributor, rotor should initially point to clamp clockwise from mark on distributor housing. Crankshaft should still be in position for firing No. 1 cylinder following valve adjustment. When distributor is pushed into place, rotor will point to mark on housing. Fig. 4 and 5.
3. Use new gaskets and rubber sealing rings.
4. When installing spark plug wires, firing order is 1-6-3-5-2-4.
5. Be sure to fill engine with oil and coolant. Retorque cylinder head bolts after assembly is completed.

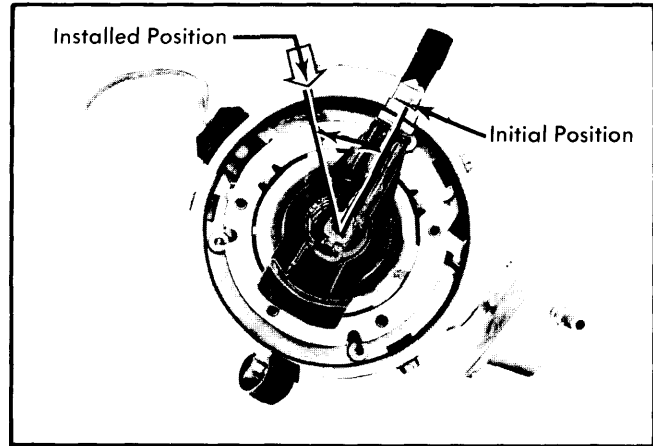

Fig. 4 Distributor Rotor Position Prior to Final Positioning

VALVES							
Engine & Valve	Head Diam. In. (mm)	Face Angle	Seat Angle	Seat Width In. (mm)	① Stem Diameter In. (mm)	① Stem Clearance In. (mm)	② Valve Lift In. (mm)
B27F Intake	1.73 (44)	30°	30°	.067-.083 (1.7-2.1)	.3140-.3146 (7.97-7.99)	.0004-.0018 (.010-.046)	LB .327 (8.3)
Exhaust	1.46 (37)	30°	30°	.079-.094 (2.0-2.4)	.3136-.3142 (7.96-7.98)	.0008-.0022 (.020-.056)	RB .321 (8.1)

① — Stem diameter gets larger from disc toward collet end of valve, where measurement above is taken.

② — Exhaust and intake valves have same lift, but valves in right bank (RB) vary from those in left bank (LB).

VALVE ARRANGEMENT

Right Bank E-I-E-I-E-I (Front-to-Rear)
 Left Bank I-E-I-E-I-E (Front-to-Rear)

ROCKER ARM ASSEMBLY

1) Mark rocker arm assemblies for right and left bank. Disassemble, keeping parts in same order as removed from shaft. Shaft-to-arm clearance should be .00047-.00213" (.012-.054 mm). Shaft diameter (new) is .7858-.7866" (19.96-19.98 mm). Replace parts as necessary.

2) Install rocker shaft support on shaft with lubricating holes downward and flat top surface of support pointing toward ring groove end of shaft. Tighten lock bolt. Install thick spacer, exhaust valve arm, thin spacer, intake valve arm, spring and rocker arm support in order. After installing three such sets, install lock ring in shaft groove.

VALVE STEM OIL SEALS AND VALVE SPRINGS

With cylinder head removed from engine, remove spark plugs, injectors, rear cover plate, lock fork and camshaft. Using valve spring compressor, remove valve collets, spring retainer, spring, lower spring seat and valve. Remove valve guide seal from guide. Place valves in order in suitable rack.

VALVE SPRINGS			
Engine	Free Length In. (mm)	PRESSURE Lbs. @ In. (kg @ mm)	
		Valve Closed	Valve Open
B27F	1.81 (47.2)	52-60@1.57 (24-27@40)	117-132@1.27 (53-60@32)

VALVE GUIDE SERVICING

1) Check valve guides for wear. If replacement is necessary, press out old guide using drift (2818). Ream hole in cylinder head to oversize class 1 or 2:

Valve Guide Specifications

Diameter	In. (mm)
Cylinder Head Hole, Class 15195-.5207 (13.19-13.23)
Cylinder Head Hole, Class 25313-.5326 (13.49-13.53)
Valve Guide, Class 1 ① .5228-.5232 (13.28-13.29)
Valve Guide, Class 2 ① .5346-.5350 (13.58-13.59)

① — Oversize Valve Guides Shown

260 SERIES V6 (Cont.)

2) Using drifts (5108 for intake; 5109 for exhaust), press in new guides. Ream guides to .3150-.3158" (8.00-8.02 mm). Check for burrs and be sure valves move freely in guides.

valves on cylinders 1, 2, and 4; exhaust valves on cylinders 1, 3, and 6 (White valves in Fig. 6).

RECONDITIONING VALVES

After inspection, grind valves, mill or grind valve seats, and lap valves with grinding paste, as necessary. Check valve springs for proper length and tension. Install seals, valves, spring seats, spring, and spring retainers. Compress spring and install collets. Remove tool, and reinstall all parts previously removed from cylinder head.

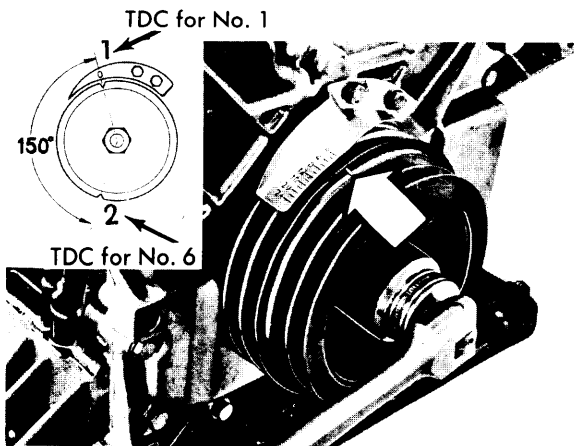

Fig. 5 Adjusting Crankshaft to Firing Position for No. 1 Cylinder

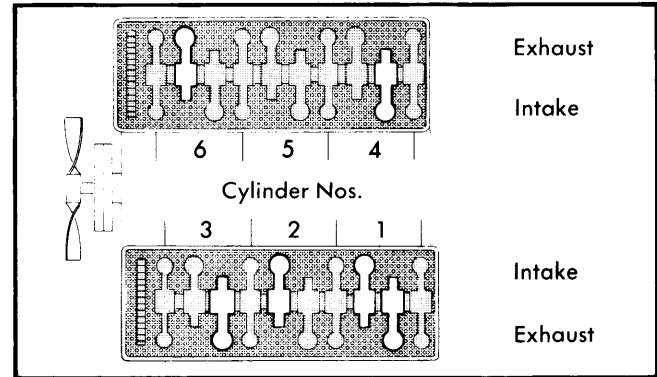

Fig. 6 Valve Clearance Adjustment Sequence

Valve Clearance Specifications^①

Valve	In. (mm)
Intake004-.006 (.10-.15)
Exhaust010-.012 (.25-.30)

① — Specifications are for cold engine.

VALVE CLEARANCE ADJUSTMENT

1) Rotate crankshaft to firing position for No. 1 cylinder. See Fig. 5. In this position, both rocker arms should have clearance. Check and adjust the following cylinders for clearance: Intake

2) Rotate crankshaft one full turn so marking is again opposite 0° mark. Rocker arms for No. 1 cylinder will now rock. Check and adjust the following cylinders for clearance: Intake valves on cylinders 3, 5, and 6; exhaust valves on cylinders 2, 4, and 5 (Grey valves in Fig. 6).

PISTONS, PINS, RINGS						
Engine	PISTONS	PINS		RINGS		
	Clearance In. (mm)	Piston Fit In. (mm)	Rod Fit In. (mm)	Rings	End Gap In. (mm)	Side Clearance In. (mm)
B27F	Demolin	Push Fit	Press Fit	Comp. 1	.016-.022 (.40-.55)	.0018-.0029 (.045-.074)
	.0035-.0043 (.090-.110)	.0005-.0008 (.013-.020)	.0008-.0016 (.020-.041)			
	Mahle	Push Fit	Press Fit	Oil	.015-.055 (.38-1.4)	.0004.0092 (.009-.233)
	.0008-.0016 (.020-.040)	.0004-.0006 (.010-.015)	.0008-.0016 (.020-.041)			

LOWER CRANKCASE

Removal — Remove oil pan and gasket, oil strainer and baffle plate. Remove 14 crankcase bolts and 8 main bearing nuts. Lift off lower crankcase. Install main bearing cap retainers (5096) on two outer bearings.

Installation — 1) Install rubber ring for oil channel. Clean and apply sealing compound to crankcase and block surfaces. Remove main bearing cap retainers and install lower crankcase.

2) Be sure crankcase and block are flush at rear end, and tighten main bearing nuts to 22 ft. lbs. torque. Use sequence shown in Fig. 7. Then back off No. 1 nut and retorqued to 22-25 ft. lbs. Using a protractor tool (5098), tighten nut an additional 73-77°. Continue in sequence retorquing one nut at a time.

3) Tighten 14 lower crankcase bolts to 11-15 ft. lbs. Install baffle plate, oil strainer, gasket and oil pan.

260 SERIES V6 (Cont.)

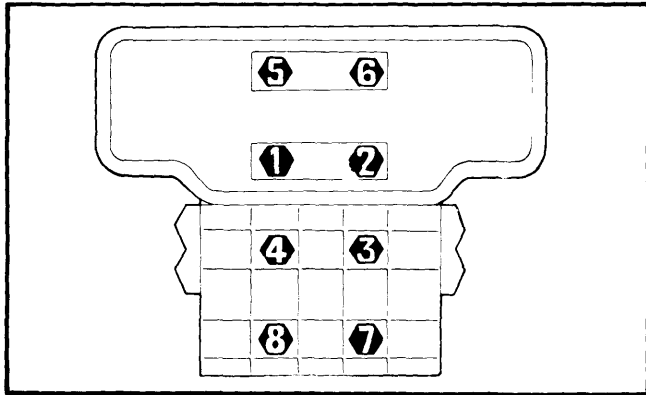

Fig. 7 Tightening Sequence for Main Bearing Nuts

PISTON & ROD ASSEMBLIES

Removal - Remove cylinder heads and lower crankcase. Check connecting rod and crankshaft markings so piston assemblies can be reinstalled in original location. Connecting rods are marked "A" through "F" from rear to front. Remove nuts and bearing cap and press connecting rod and piston out of cylinder liner after removing carbon ridge from bore. Remove big-end bearing.

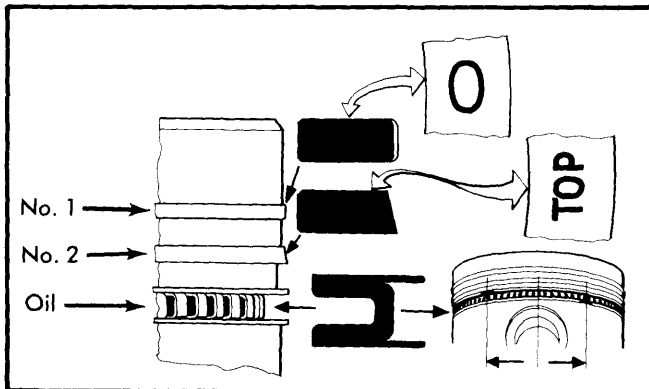

Fig. 8 Piston Ring Location & Markings

Installation - Install piston & rod assemblies one cylinder at a time. Connecting rods and caps are marked "A" through "F" from rear to front for cylinders 1-4-2-5-3-6. Adjust rings so end gaps are not aligned. Oil rings and install piston with arrow marking on top pointing toward front of engine. Using installation tool (5106) press piston into liner. Install connecting rod cap after oiling the bearing. Tighten cap to 33-37 ft. lbs.

PISTONS AND LINERS

1) Pistons and liners are matched. Pistons are marked "A", "B", or "C" according to diameter and correspond to liners "1", "2", or "3" (marked in recesses at top of liners). Pistons and piston pins are also marked blue, white or red for proper matching.

2) Two types of pistons are used, Demolin (overall height 2.695" or 68.45 mm) and Mahle (overall height of 2.474" or 62.85 mm). Measure piston diameter at right angles to pin bore. Measure Demolin pistons .433" (11 mm) above lower edge of piston; Mahle pistons .236" (6 mm) above lower edge.

Piston and Liner Diameters^①

Piston	In. (mm)
Demolin A	3.4610-3.4614 (87.910-87.920)
Demolin B	3.4614-3.4618 (87.920-87.930)
Demolin C	3.4618-3.4622 (87.930-87.940)
Mahle A	3.4634-3.4638 (87.970-87.980)
Mahle B	3.4638-3.4642 (87.980-87.990)
Mahle C	3.4642-3.4646 (87.990-88.000)

Liner	In. (mm)
No. 1 for A Piston	3.4646-3.4650 (88.00-88.01)
No. 2 for B Piston	3.4650-3.4654 (88.01-88.02)
No. 3 for C Piston	3.4654-3.4657 (88.02-88.03)

① - Measurements for new parts.

3) To determine piston-to-cylinder clearance, subtract piston diameter from maximum and minimum bore diameters. Do not remove pistons from connecting rods, unless piston and liner replacement is necessary.

4) If liner is to be removed for cleaning or inspection, mark liner and block with colored pen. Do not damage gasket surface. Remove liner holders and pull up liners. When installing liners, be sure contact surfaces on block and liner are clean and without defect. Install No. 1 liner first (without shims) using previous pen markings for alignment. Tighten liner by hand, using two liner holders (5093). Using dial indicator, measure liner height above block at three points. Largest measurement should not exceed smallest measurement by more than .002" (.05 mm). Liner should be as close to .0091" (.23 mm) above block face as possible. Use correct shims to achieve dimension:

Liner Shim Thicknesses^①

Color	Thickness - In. (mm)
Blue0028-.0041 (.070-.105)
White0033-.0047 (.085-.120)
Red0041-.0055 (.105-.140)
Yellow0051-.0065 (.130-.165)

① - Use same thickness shims for all liners.

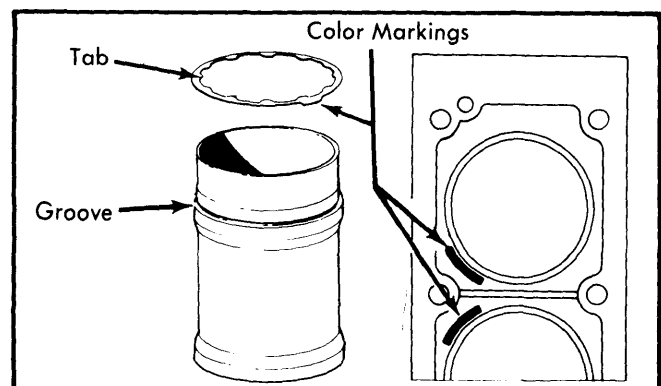

Fig. 9 Positioning Shims on Liners

260 SERIES V6 (Cont.)

5) Install shims with color marking up and positioned as shown in Fig. 9. Inner tabs on shims should be in liner groove.

6) After shimming, install four liner holders (5093) for each bank. Again measure each liner at three points. Largest and smallest dimensions should be within .002" (.05 mm). Measure three liners at points shown in Fig. 10. Difference in measurements between points "1" and "2" and between "3" and "4" should not exceed .0016" (.04 mm). If height difference is excessive, change shims.

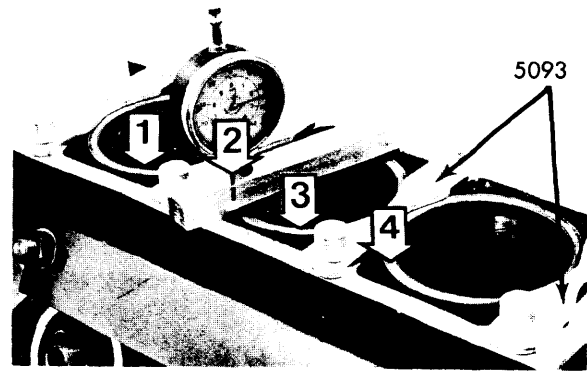

Fig. 10 Checking Liner Height Above Block Face

CRANKSHAFT MAIN & CONNECTING ROD BEARINGS							
Engine	MAIN BEARINGS				CONNECTING ROD BEARINGS		
	Journal Diam. In. (mm)	Clearance In. (mm)	Thrust Bearing	Crankshaft End Play In. (mm)	Journal Diam. In. (mm)	Clearance In. (mm)	Side Play In. (mm)
B27F	2.7576-2.7583 (70.043-70.062)	.0015-.0035 (.038-.088)0028-.0106 (.070-.270)	2.0578-2.0585 (52.267-52.286)	.0012-.0021 (.030-.053)	.008-.015 (.20-.38)

CRANKSHAFT

Removal - 1) Remove oil pan, lower crankcase, cylinder heads, clutch, drive plate or flywheel, spacer (automatic transmission) and input shaft pilot bearing (manual transmission). Remove seal holder and use drift (5107) to press out seal. Press new seal in flush with retainer.

2) Check main bearing cap markings (marked 1 through 4, from rear-to-front). Remove main bearing retainers and caps. Remove upper and lower thrust bearings and lift out crankshaft. Remove main bearings from block and caps.

Installation - 1) Oil and install main bearings (with lubricating holes) in block. Place crankshaft in block. Oil and install "hooked" thrust bearings in block groove. Oil and install "non-hooked" thrust bearings on crankshaft.

2) Oil bearing and install in main bearing cap. Position cap with "1" marking toward front of engine. Install main bearing retainers (5096). Check crankshaft end play and install thrust bearing washers as necessary.

3) Install other three main bearing caps and main bearing retainers (5096) on front cap. Install caps with "2", "3", and "4" marks toward front of engine. Position gasket on seal retainer, align flush with block and torque to 7-11 ft. lbs. Install other components previously removed.

TIMING GEAR COVER

Removal - Remove both valve covers, lock flywheel (5112), and remove crankshaft nut. Remove pulley while key is on top of shaft (prevents dropping key in crankcase). Use puller (5069) to remove crankshaft seal. Remove timing gear cover.

Installation - Clean surfaces and place gaskets on block and timing gear cover. Install cover and tighten bolts to 7-11

ft. lbs. Install crankshaft seal (drift 5103). Block flywheel with locking tool (5112), install pulley and tighten crankshaft nut to 118-132 ft. lbs.

CHAINS & SPROCKETS

Removal - 1) Remove timing gear cover, oil pump chain, sprocket, oil pump and gears. Turn each tensioner lock 1/4 turn counterclockwise and push in piston to slacken camshaft chains. Remove both tensioners, strainers, and curved and straight dampers. Remove camshaft sprockets and chains.

2) Stuff rag in holes near crankcase to keep key from falling in crankcase. Remove outer sprocket and inner double sprocket from crankshaft (either by hand or with puller).

CAMSHAFT			
Engine	Journal Diam. In. (mm)	Clearance In. (mm)	Lobe Lift In. (mm)
B27F Front	1.5921-1.5931 (40.440-40.465)	⓪.0014-.0033 (.035-.085)
2nd	1.6157-1.6173 (41.040-41.065)		
3rd	1.6394-1.6404 (41.640-41.665)		
4th	1.6630-1.6640 (42.240-42.265)		

⓪ - End play should be .0028-.0057" (.070-.144 mm).

Installation - 1) Place key in crankshaft. Oil sprocket and shaft. Install double sprocket (drift 4028) with mark outward. Install spacer ring and outer key. Install oil pump sprocket, strainers and chain tensioners, and curved and straight dampers.

260 SERIES V6 (Cont.)

2) Rotate crankshaft so key aligns with camshaft in left bank (No. 1 cylinder at TDC). Position camshaft so key points upward (rocker arms for No. 1 cylinder rock). Place chain on camshaft sprocket so that link between two white lines is centered over camshaft sprocket timing mark. Place chain on inner crankshaft sprocket so timing mark on sprocket is aligned with white mark on chain. Install left camshaft sprocket onto camshaft so that pin on sprocket slips into recess in camshaft. Chain should be stretched on tension side. Use screwdriver to hold sprocket and tighten center bolt to 51-59 ft. lbs.

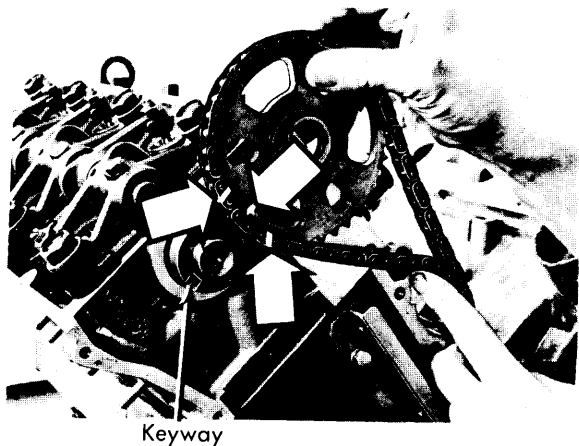

Keyway

Fig 11 Right Camshaft Keyway and Timing Marks

3) Rotate crankshaft clockwise 150° so that key points straight downward. Set right camshaft so keyway is in position shown in Fig. 11. Place chain on sprocket so link between white lines on chain aligns with sprocket timing mark. Place chain on crankshaft center sprocket so that chain and sprocket timing marks align. Fit sprocket on camshaft with chain stretched on tension side. Pin on sprocket should slip into camshaft recess. Use screwdriver to hold sprocket and torque center bolt to 51-59 ft. lbs.

4) Turn lock on each chain tensioner 1/4 turn clockwise. Tension chains by rotating crankshaft 2 full turns in direction of rotation (clockwise). Remove crankshaft nut. Markings on chains and sprockets will no longer align. Reassemble oil pump, install chain and chain sprocket. Install timing gear cover after removing rag from crankcase holes.

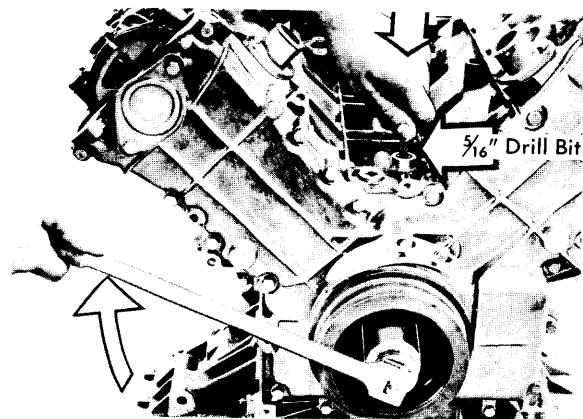

Fig. 12 Locating Top Dead Center for No. 1 Cylinder

IGNITION TIMING PLATE

1) Rotate crankshaft so that mark No. 1 (See Fig. 5) is at 20° mark on ignition timing plate. Remove plug and insert 5/16" drill bit or similar rod into hole and against crankshaft counterweight, See Fig. 12. Rotate crankshaft in direction of rotation until drill bit can be pressed into recess in counterweight (TDC for No. 1 cylinder).

NOTE — Do not drop drill bit into engine. Use drill or pin up to 10" long.

2) Loosen two bolts and adjust ignition timing plate so that "0" mark is aligned with pulley mark. Tighten two bolts, remove drill bit or rod and install plug. Check camshaft setting. Valve clearance should be .28" (.7 mm). Intake valve should open at:

Intake Valve Opening

Valve	Crankshaft Degrees
Left bank	9° ± 3° BTDC
Right bank	7° ± 3° BTDC

ENGINE OILING

Crankcase Capacity — 7.4 quarts including filter.

Oil Filter — Full-flow type, disposable spin-on element.

Oil Pressure — 26 psi @900 RPM; 57 psi @3000 RPM with engine warm and new filter.

ENGINE OILING SYSTEM

Engine utilizes a force-feed lubrication system. Oil moves from oil pan through strainer to oil pump and full-flow oil filter mounted outside of engine block assembly. Oil is pressure fed from filter to drilled galleries in block.

Lubricant moves under pressure to main bearings, which are drilled to pass oil on to connecting rod and camshaft

bearings, upward in block to rocker arm shafts. Excess or runoff oil drains back down into oil pan through drain holes in cylinder head. Cylinder walls and piston rings are lubricated by splash from connecting rods.

OIL PUMP

Removal & Installation — 1) See *Chains and Sprockets*. Inspect housing, cover and gears for damage or wear. Replace if necessary.

2) Oil pumps are serviced as complete units (pump cover with impeller and relief valve).

Volvo Engines

260 SERIES V6 (Cont.)

ENGINE OILING (Cont.)

Oil Pump Specifications^①

Dimension	In. (mm)	Dimension	In. (mm)
Pump Gear Width, Class 1 ..	1.2167-1.2175 (30.905-30.925)	Clearance (Tooth-to-Housing)	①.0043-.0073 (.11-.185)
Pump Gear Width, Class 11	1.2175-1.2183 (30.925-30.945)	Backlash	①.007-.011 (.17-.27)
Pump housing width, class 1	1.2185-1.2183 (30.925-30.945)	Bearing Clearance, Driving Shaft0006-.0021 (.015-.053)
Pump housing width, class 11	1.2195-1.2209 (30.975-31.010)	Bearing Clearance, Trailing Shaft0006-.0020 (.015-.051)
Endplay0010-.0033 (.025-.084)	Relief Valve Spring Length, No Load	3.52 (89.4)
		Relief Valve Spring Length, 19.8 lbs. ...	2.22-2.38 (56.5-60.5)

① — Excluding bearing clearance.

ENGINE COOLING

Thermostat — Wax-type. Begins to open at 176-181° F (80-83° C); fully open at 194-201° F (90-94° C). Marking, 180° F (82° C).

radiator hose and automatic transmission oil cooler pipes. Remove fan shroud, radiator and fan.

Cooling System Capacity — 12 quarts (10.0 liters).

WATER PUMP

1) Drain coolant from both sides of block. Remove intake manifold, two expansion tank hoses from radiator, upper

2) Remove hoses from pump to block. Remove fan belts, water pump pulley, and remaining hose clamps. Remove senders from water pump, and pump from block. Remove cover and thermostat and cover from body. Install in reverse order.

TIGHTENING SPECIFICATIONS

Application	Ft. Lbs. (mkg)
Cylinder Head Bolts	
Step One	7 (1.0)
Step Two	22 (3.1)
Step Three	①44 (6.1)
Main Bearing Cap Nuts	②22-25 (3.1-3.5)
Connecting Rod Cap Nuts	33-37 (4.6-5.1)
Flywheel Bolts	33-37 (4.6-5.1)
Clutch-to-Flywheel Bolts	15-18 (2.1-2.5)
Camshaft Center Bolts	51-59 (7.1-8.2)
Crankshaft Pulley Nut	118-132 (16.3-18.3)
Alternator Attaching Bolts	29-37 (4.0-5.1)
Fan Hub	22-37 (3.1-5.1)
Spark Plugs	13-15 (1.8-2.1)
Oil Pressure Sensor	26-37 (3.6-5.1)
Temperature Sensor	18-22 (2.5-3.1)
Coolant Drain Cocks	18-25 (2.5-3.5)
Transmission-to-Engine	30-36 (4.2-5.0)
Front Engine Mounts	11-18 (1.5-2.5)
Oil Pan Plug	18-25 (2.5-3.5)
Exhaust & Intake Manifolds	7-11 (1.0-1.5)
Valve Covers	7-11 (1.0-1.5)
Water Pump-to-Block	11-15 (1.5-2.1)

① — After step 3, wait 10-15 minutes, slacken bolts and retorque to 11-14 ft. lbs. (1.5-1.9 mkg). Protractor torque to 116-120°. Run engine until hot and cool for 30 minutes. Slacken and retorque each individual bolt in stages again to 11-14 ft. lbs. (1.5-1.9 mkg) and protractor torque 113-117°.

② — Torque all nuts to 22 ft. lbs. (3.1 mkg). Slacken No. 1 nut, retorque to 22-25 ft. lbs. (3.1-3.5 mkg), and protractor torque 73-77°. Repeat procedure for other seven nuts in sequence.