

## TYPE 2 2000 cc 4 CYLINDER

GENERAL SPECIFICATIONS										
Year	Displ.		Carburetor	HP at RPM	Torque (Ft. Lbs. at RPM)	Compr. Ratio	Bore		Stroke	
	cu. ins.	cc					in.	mm	in.	mm
1976	120	1970	Fuel Injection	.....	.....	7.3-1	3.70	94	2.795	71

### ENGINE IDENTIFICATION

Engine code number is stamped on crankcase below breather, near coil. First two digits of cast number are engine code.

#### Engine Identification

Application	Engine Code
Type 2 .....	GD

### ENGINE

**Removal** – 1) Remove air cleaner. Disconnect battery. Disconnect electrical wiring from the following components: distributor, regulator, oil pressure sending unit, and transmission switch. Make sure to tag each wire for reinstallation. Disconnect back-up light lead at in-line fuse. Fuse is located near coil. Disconnect wire from temperature sensor, if equipped.

2) Disconnect fuel injection wiring harness from coil, injectors, intake air distributors, crankcase, temperature sensors. Disconnect evaporation canister hoses. Remove coil. Remove ducting between warm air blower and heat exchanger. Disconnect accelerator cable from lever on throttle valve shaft.

3) Remove oil filler neck and dipstick. Remove rear side engine cover plates. On automatic transmission models, remove transmission filler pipe by rotating counterclockwise. Also, disconnect vacuum line from intake air distributor. On automatic transmission models, remove converter bolts through opening in lower left side of bell housing. Disconnect starter electrical wires.

4) Disconnect heater control cables. Remove ducting connecting heat exchangers with inside of vehicle. Remove both upper engine to transmission mounting bolts. Place a support (VW785) under transmission. Pull accelerator from guide tube. Disconnect fuel line from pressure regulator and plug opening. Remove both lower engine to transmission mounting bolts.

5) Place a floor jack (or equivalent) under engine. Raise jack until engine is just supported. Remove bolts mounting engine brackets to frame. Slide engine assembly slightly to rear to free input shaft. Lower engine to floor.

**NOTE** – On vehicles equipped with automatic transmissions, install strap across converter to prevent torque converter from sliding off support tube.

**Installation** – To install, reverse removal procedure and note following: When lining up engine and transmission, place transmission in gear, set parking brake and hand turn crankshaft until splines line up. Make sure rubber seal

between engine cover and body is properly positioned. Lubricate clutch release bearing, transmission drive shaft and starter drive bushing (Bosch starters).

### INTAKE MANIFOLD

**Removal** – 1) Fuel injection manifold can be removed with engine in vehicle. Remove air cleaner, hoses, and pressure switch.

2) Disconnect wires on fuel injectors and remove two screws. Pull injectors off with plate and retainer. Make sure locating bushings are removed from manifold. Disconnect hoses on injectors and remove.

3) Remove intake manifold cover plate. Remove nuts and washers securing manifold to cylinder heads. Lift up on manifold and pull from tubes on air distributor.

**Installation** – To install manifold, reverse removal procedure and note the following: Use new gaskets and tighten intake manifold mounting nuts uniformly. Make sure gray protective cap on injector is to rear and cap is to front.

### CYLINDER HEAD

**NOTE** – Engine must be removed from vehicle and manifolds removed, before removing cylinder heads. If cylinders are not to be removed, use retaining device to keep cylinders from pulling free.

**Removal** – 1) Remove rocker arm cover and gasket. Remove rocker arm shaft retaining nuts, loosening gradually one at a time to relieve spring tension evenly. Remove rocker arm assemblies.

2) Remove push rods, keeping in order for reassembly. Loosen cylinder head nuts gradually working in sequence from outside toward center.

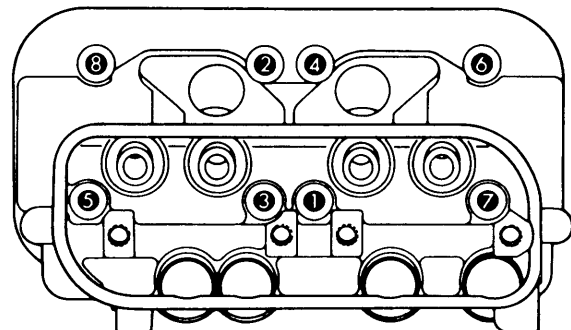

Fig. 1 2000 cc Engine, Cylinder Head Bolt Tightening Sequence

# Volkswagen Engines

## TYPE 2 2000 cc 4 CYLINDER (Cont.)

**Installation** — Install new seal on push rod tubes. Install cylinder head with new gasket over studs. Loosely attach head nuts and washers. Torque cylinder head according to se-

quence shown in Fig. 7. Install push rod tube in place by sliding through top of cylinder head. Reverse removal procedure for remaining components.

VALVES							
Engine & Valve	Head Diam. In. (mm)	Face Angle	Seat Angle	Seat Width In. (mm)	Stem Diameter In. (mm)	Stem Clearance In. (mm)	Valve Lift In. (mm)
2000 cc Int.	1.476 (37.5)	29.5	30°	.071-.087 (1.80-2.21)	.3125-.3129 (7.936-7.948)	.018 (.46)	.....
Exh.	1.299 (33.0)	45°	45°	.079-.098 (2.01-2.49)	.3508-.3512 (8.910-8.920)	.014 (.35)	.....

### VALVE ARRANGEMENT

E-I-I-E (both banks)

### VALVE GUIDE SERVICING

1) Place valve in valve guide with stem flush with end of guide. With dial indicator, measure valve rock at valve head. If rock exceeds .035" (.89 mm), replace valve guide or valve. Valve guide with inside machined shoulder is exhaust.

2) To replace valve guide, drill guide with shouldered drill to depth of 1 1/2"-2" using slow speed drill. Drive guides down through cylinder head with suitable tool. Drive oversize guide from top of cylinder head using press. Pressure required should be 2000-4000 lbs. Ream guides to proper fit.

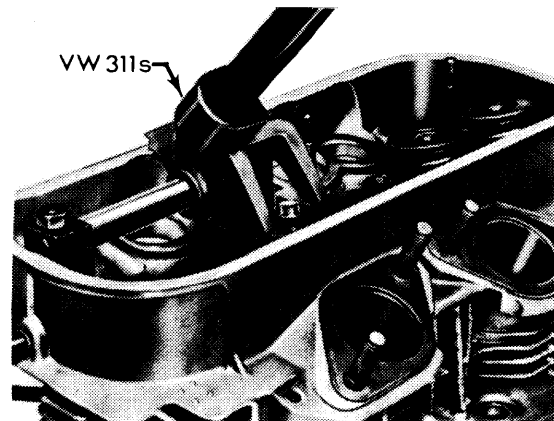

Fig. 2 Using Special Tool VW 311s to Remove Valve Spring

VALVE SPRINGS			
Engine	Free Length In. (mm)	PRESSURE Lbs. @ In. (kg @ mm)	
		Valve Closed	Valve Open
2000 cc Int. & Exh.	.....	168-186@1.14 (76.20-84.37@28.96)	.....

### VALVE SPRINGS

**NOTE** — Valve spring may be removed with cylinder head installed. Apply constant air pressure (minimum 85 psi) to cylinder through spark plug hole to hold valve in place while compressing spring.

**Removal** — Remove cylinder head cover and rocker arm shaft. Install suitable valve spring compressor tool (VW311s with cylinder head removed, VW653/2 with cylinder head installed). Compress spring retainer and spring and remove valve keepers. Release compressor and remove spring retainer and spring.

**Installation** — Install valve, valve spring, and valve spring retainer. **NOTE** — Install spring with closely spaced coils against cylinder head. Compress spring with suitable compressor and install valve keepers.

### ROCKER ARM ASSEMBLY

**Removal** — Disengage wire valve cover clip. Remove valve cover. Remove 4 rocker shaft retaining nuts. Each side has two separate shafts. Make sure mounting nuts are gradually and evenly loosened until spring tension is relieved.

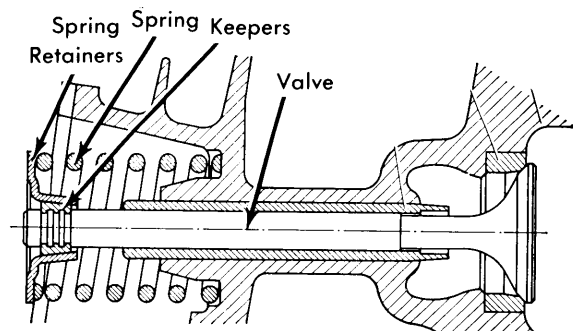

Fig. 3 Sectional View of Valve with Related Parts

## TYPE 2 2000 cc 4 CYLINDER (Cont.)

**Inspection** — Check rocker arms and shafts for wear. If inside diameter of rocker arm is worn more than .789" (20.0 mm), replace rocker arm. If diameter of rocker shaft is worn to less than .783" (19.9 mm), replace rocker shaft.

**Installation** — To install, reverse removal procedure and note: Make sure push rod tube retaining wire is reinstalled. Adjust valve clearance.

### VALVE CLEARANCE ADJUSTMENT

Valve clearance is checked or adjusted with engine cold. Rotate engine until piston of valve being adjusted is at TDC of compression stroke. Both valves can be adjusted at same time. Adjust both intake and exhaust valves to .006" (.15 mm).

PISTONS, PINS, RINGS						
Engine	PISTONS	PINS		RINGS		
	Clearance In. (mm)	Piston Fit In. (mm)	Rod Fit In. (mm)	Rings	End Gap In. (mm)	Side Clearance In. (mm)
2000 cc	.0016-.0023 (.041-.058)	①	.0004-.0012 (.010-.030)	1	.014-.021 (.35-.55)	.0023-.0035 (.058-.089)
				2	.012-.021 (.30-.55)	.0016-.0028 (.041-.071)
				3	.010-.016 (.25-.41)	.0008-.0019 (.020-.048)

① — Push fit with light thumb pressure.

### CYLINDERS

**Removal** — Remove engine and remove cylinder head.

**NOTE** — Mark cylinders to insure they are reinstalled in original position. Remove deflector plates from bottom of cylinders and pull cylinders from pistons.

**Installation** — 1) Check seating surfaces of cylinders on both ends. Make sure seating areas are perfectly clean and true before installing cylinders. Stagger ring gaps 90° apart so that oil ring gap faces upward when cylinder is installed.

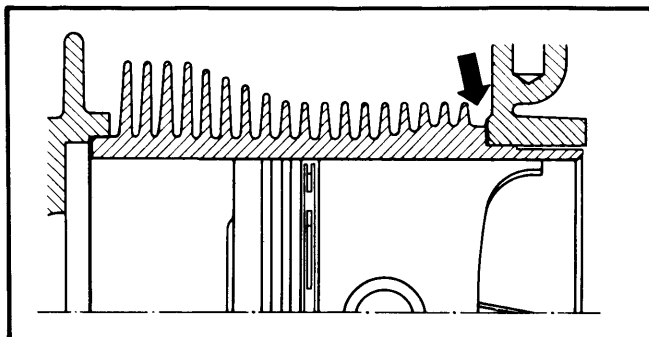

Fig. 4 Location and Seating of Cylinder Seal

2) Apply oil to cylinder, piston, rings and piston pin. Compress rings with suitable ring compressor (VW123). Install new sealing gasket on crankcase side and slide cylinder over piston.

3) Make sure studs do not contact cooling fins when cylinder is completely seated against crankcase. Install cylinder deflector plates and remaining components in reverse of removal.

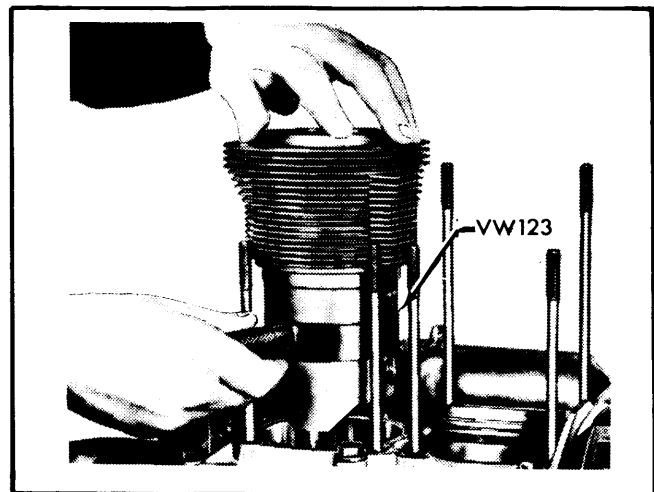

Fig. 5 Installing Cylinder Assembly into Case

### FITTING PISTONS

1) With piston and cylinder removed, measure clearance between piston and cylinder. Check piston size at bottom of skirt and 90° to piston pin. Check cylinder size at several points throughout cylinder, using largest reading to determine clearance.

2) If clearance exceeds .008" (.20 mm), replace piston and cylinder as a set. New piston must be of same weight grade as original or within 10 g of original piston weight. Piston size, weight and installation position are marked on top of piston (See Fig. 6). Piston and cylinders are available in two oversizes .020" and .040".

**NOTE** — Piston alone may be replaced with one of matching size. Only pistons of same size and weight grade should be installed in same engine.

## TYPE 2 2000 cc 4 CYLINDER (Cont.)

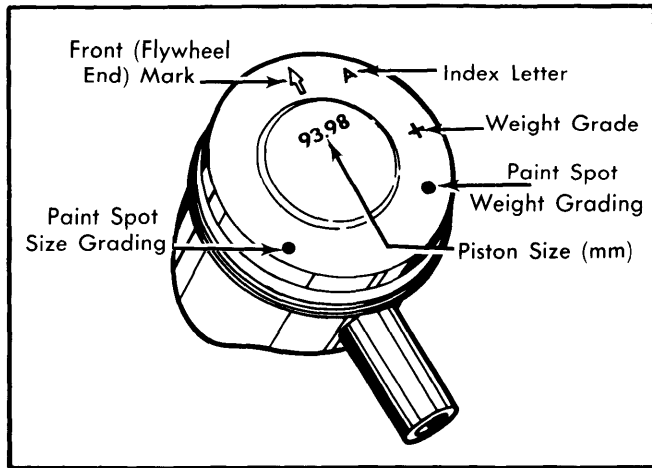

Fig. 6 Top View of Piston with Detail of Piston Markings

3) New piston rings are size graded to match piston/cylinder sets. Measure ring gap with ring installed approximately  $\frac{1}{4}$ " in cylinder. If ring end gap exceeds .035" (.89 mm) for compression rings or .037" (.95 mm) for oil scraper, replace.

4) Install rings on piston and measure ring side clearance using a feeler gauge. If clearance exceeds .005" (.13 mm), on top ring or .004" (.10 mm) on second or oil ring, piston must be replaced.

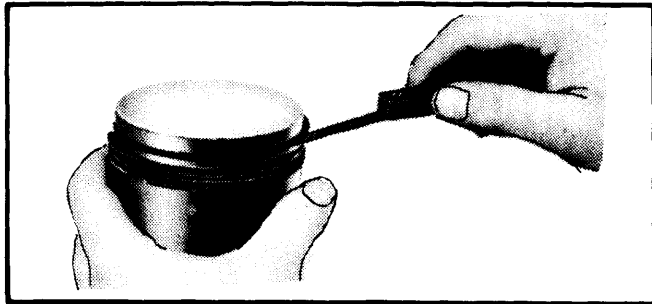

Fig. 7 Measuring Piston Ring Side Clearance with Feeler Gauge

## PISTON PINS

**Removal** — Remove cylinders and mark pistons before removing for proper installation. Using suitable pliers (VW122b), remove piston pin circlips and push piston pin out of piston.

**Installation** — 1) Check fit of pin in piston. Piston pin should be light push fit with piston at 68-167°F. If pin is too loose, both pin and piston must be replaced. Check clearance of pin in rod. If clearance exceeds .0016" (.041 mm), replace piston pin and rod bushing. See *Piston Pin Bushing Replacement*.

**NOTE** — During manufacturing some pistons were made with oversize bores. Oversize pins are supplied for these pistons and are identified by a green paint spot. No attempt should be made to compensate pin or bushing wear with oversize pin.

2) Install one circlip in piston on side facing flywheel. Position piston on connecting rod and push piston pin through piston. Replace remaining circlip. **NOTE** — Piston may be heated to ease pin installation. Replace remaining components in reverse of removal.

## PISTON PIN BUSHING REPLACEMENT

1) At normal temperature, piston pin should push fit in connecting rod. If side clearance is felt with a new pin installed, bushing must be replaced and reamed to correct fit with a new piston pin.

2) Press bushing out using a suitable mandrel and components (VW402, 409, 421 and 416B). Install new bushing using same procedure and tools as used for removal.

3) Drill through oil holes in connecting rod. Ream bushing to provide a .0004-.0012" (.01-.03 mm) clearance. Bushing should be free of chatter marks when reaming is completed. Piston pin should be a push fit into bushing without oil.

## CRANKSHAFT MAIN &amp; CONNECTING ROD BEARINGS

Engine	MAIN BEARINGS				CONNECTING ROD BEARINGS		
	Journal Diam. In. (mm)	Clearance In. (mm)	Thrust Bearing	Crankshaft End Play In. (mm)	Journal Diam. In. (mm)	Clearance In. (mm)	Side Play In. (mm)
2000 cc No. 1	2.3609-2.3617 (59.967-59.987)	.0016-.0039 (.041-.099)	No. 1	.0027-.0050 (.069-.127)	1.9677-1.9685 (49.98-50.00)	.0008-.0027 (.020-.069)	.004-.016 (.10-.41)
2	2.3609-2.3617 (59.967-59.987)	.0012-.0035 (.030-.089)					
3	2.3609-2.3617 (59.967-59.987)	.0016-.0039 (.041-.099)					
4	1.5739-1.5748 (39.977-40.025)	.0020-.0039 (.051-.099)					

## TYPE 2 2000 cc 4 CYLINDER (Cont.)

### CRANKCASE

Crankcase must be taken apart to replace connecting rods, connecting rod bearings and main bearings. It is also necessary to disassemble crankcase to remove crankshaft, camshaft, and camshaft bearings.

**Disassembly** — 1) Remove engine from vehicle and remove cylinder heads, cylinders, and pistons. Remove flywheel or drive plate, and crankshaft pulley. Remove distributor, distributor drive shaft and fuel pump.

2) Remove oil cooler, oil filter and bracket, and oil pump assembly. See *Oil Pump Removal*. Remove rear engine carrier crossmember, bonded rubber mountings, and fan hub. Remove oil pan and oil filler pipe mounting bracket bolt.

3) Remove six 10 mm nuts and five 8 mm bolts and nuts. Using spring clips, clamp tappets in right hand crankcase half and lift off right hand crankcase half. **CAUTION** — Never use sharp tool to pry crankcase halves apart. Smallest scratches will cause oil leak. Use rubber hammer to loosen crankcase halves.

**Assembly** — 1) Thoroughly clean and inspect both crankcase halves. Remove old sealing compound from mating surfaces and from all bolts, studs and washers. Blow out oil passages with compressed air. Check studs for tightness and check oil suction pipe for tightness.

2) Install crankshaft with connecting rods, in left side crankcase half, making sure dowel pins are properly seated in bearings. Install camshaft. See *Camshaft Installation*. Install camshaft plug using liquid sealer all around plug. Spread liquid sealer over mating surfaces of crankcase halves.

3) Using spring clips, clamp tappets in right hand half of crankcase and join crankcase halves. Coat main bearing bolt heads (10 mm) with sealer and install in crankcase. **NOTE** — Install plastic dampers (part No. 021 101 107) on shank of main bearing bolts whether or not originally equipped.

4) Coat the sealing nuts for main bearing bolts with sealer and install nuts with sealing rings outward. Tighten main bearing nuts and bolts and hand turn crankshaft to check for free movement. Coat bolt heads and nuts of 8 mm bolts with sealer, then install and tighten.

5) Check crankshaft end play. See *Thrust Bearing Alignment*. Install new crankshaft oil seals. See *Front Crankshaft Oil Seal Replacement and Rear Crankshaft Oil Seal Replacement*. Install remaining components in reverse of removal procedure.

### MAIN & CONNECTING ROD BEARING SERVICE

1) With crankshaft and connecting rod assembly removed, remove snap ring securing distributor drive gear and crankshaft gear to crankshaft. Remove distributor drive gear and crankshaft gear by pressing or using a suitable mandrel (VW457). Remove number three bearing. Remove connecting rods.

2) Thoroughly clean and inspect crankshaft. Blow out oil passages with compressed air. Check runout of crankshaft, if

runout is more than .0008" (.020 mm), regrind crankshaft to next undersize.

3) Check crankshaft journals for wear, if journals are worn more than .0012" (.030 mm), regrind crankshaft to next undersize. Main and connecting rod bearings are available in .010", .020" and .030" undersize.

4) Lubricate and install number three bearing. Heat crankshaft to approximately 176°F in an oil bath and install crankshaft and distributor drive gears using suitable drivers (VW427, VW428 and VW415a). Install snap ring.

5) Using Plastigage method, check main and connecting rod bearings. If main bearing clearance on Nos. 1 and 3 exceeds .007" (.18 mm), .0067" (.17 mm) on No. 2, or .0075" (.19 mm) on No. 3; replace bearing. If clearance on any connecting rod bearing exceeds .007" (.15 mm), replace bearing.

6) Install Nos. 1, 3, and 4 main bearings on crankshaft. See Step 4 for No. 3 main bearing installation. Install lower bearing half of No. 2 bearing in crankcase. Make sure bearing engages hole in bearing half. Turn bearings on crankshaft to align oil holes. Install connecting rod bearing halves in rod cap and rod. Fit to crankshaft with numbers on rod and cap on same side. Forged mark on connecting rod must face up when crankshaft is installed.

7) Check connecting rod side play with feeler gauge. If side play exceeds .0275" (.70 mm), replace connecting rod. Install crankshaft and connecting rod assembly as previously outlined. Check crankshaft end play. See *Thrust Bearing Alignment*.

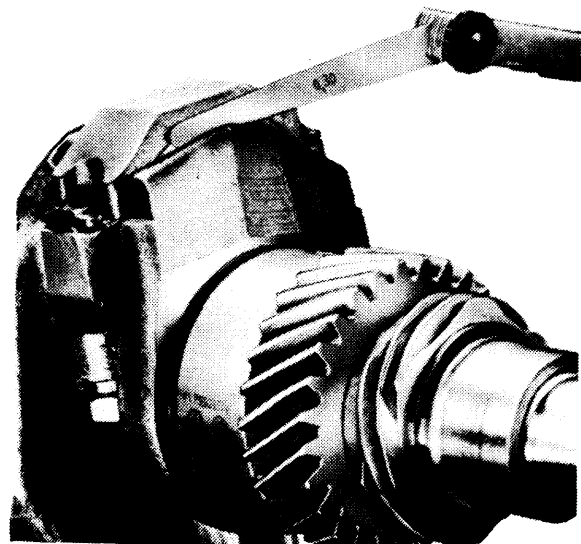

Fig. 8 Using a Feeler Gauge to Check Connecting Rod Side Clearance

### THRUST BEARING ALIGNMENT

**NOTE** — Crankshaft end play is checked with engine assembled.

1) Install flywheel with two shims, but do not install crankshaft oil seal. Attach dial indicator to crankcase and measure back and forth movement of crankshaft.

## TYPE 2 2000 cc 4 CYLINDER (Cont.)

2) Calculate necessary thickness of third shim. Install third shim and recheck end play. Thickness of shim is etched on face of shim, always use three shims to obtain correct end play.

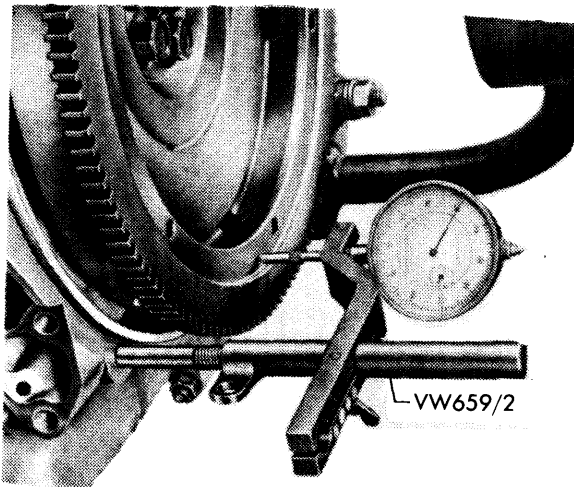

Fig. 9 Using a Dial Indicator to Check Crankshaft End Play

### Thrust Bearing Shims

MM Markings On Shim	Inch Equivalent
.24 mm .....	.0094"
.30 mm .....	.0118"
.32 mm .....	.0126"
.34 mm .....	.0134"
.36 mm .....	.0142"
.38 mm .....	.0150"

3) With correct shim thickness determined, install crankshaft oil seal. See *Front Crankshaft Oil Seal*. Install flywheel, tighten bolts as required, and recheck crankshaft end play.

### FRONT CRANKSHAFT OIL SEAL

1) Remove flywheel and pry out crankshaft oil seal. Make sure seal seat in crankcase is clean. If necessary, chamfer edges of seal seat.

2) Press seal into crankcase, using a suitable seal installer (VW191). Make sure seal is seated in bottom of crankcase. Lubricate sealing edge of seal, install flywheel, and tighten bolts.

### REAR CRANKSHAFT OIL SEAL

1) Remove cooling blower impeller from rear of engine. Remove impeller hub, using a suitable puller (VW185).

2) Pry out old seal and thoroughly clean seal seat in crankcase. Chamfer edges of seal seat, if necessary. Press new seal into crankcase, using a suitable seal installer (VW190). Make sure seal is seated in bottom of crankcase. Lubricate sealing edge of seal and install cooling blower impeller.

### DISTRIBUTOR DRIVE INSTALLATION

When crankcase has been assembled, and remaining components installed, distributor drive must be installed. Rotate crankshaft until No. 1 piston is at TDC, compression stroke. Align timing mark on pulley with 0° mark on ignition timing scale. Insert distributor drive with slot at a 12° angle to center line of engine. Small segment of slot must face toward outside of vehicle (See Fig. 10).

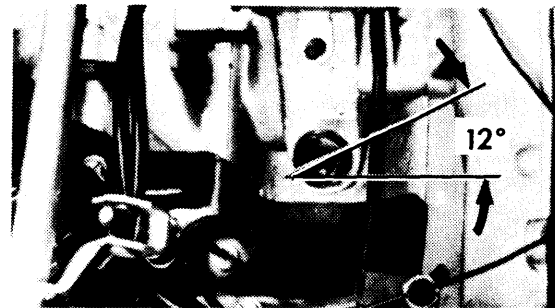

Fig. 10 Engine Distributor Drive Installation Position

### CAMSHAFT

Engine	Journal Diam. In. (mm)	Clearance In. (mm)	Lobe Lift In. (mm)
2000 cc	.9839-.9843 (24.991-25.001)	.0008-.0020 (.020-.051)	.....

### CAMSHAFT INSTALLATION

1) With camshaft removed, check riveting of camshaft gear to camshaft. Check camshaft for runout, if runout exceeds .0016" (.041 mm), replace camshaft.

2) Check gear backlash with camshaft and crankshaft installed in crankcase half. Correct backlash is .002" (.05 mm). Gears have correct fit when crankshaft is rotated backwards and camshaft does not try to lift out of bearings.

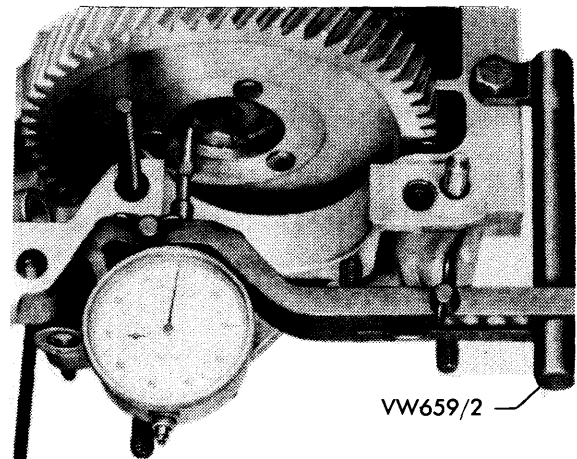

Fig. 11 Measuring Camshaft End Play with a Dial Gauge

## TYPE 2 2000 cc 4 CYLINDER (Cont.)

3) If camshaft rises out of bearings, teeth on camshaft gear have the wrong pitch radius for crankshaft gear. Camshafts with gears that have various pitch radii are available. Pitch radius is stamped on back of gear facing number three bearing journal of camshaft.

4) Install camshaft with "O" stamped in tooth on outside of camshaft gear between two teeth with punch marks on crankshaft gear. Assemble crankcase halves as previously outlined (See Fig. 12).

### CAMSHAFT END PLAY

Camshaft end play is checked with camshaft installed in crankcase half. Measure back and forth movement of camshaft with a dial indicator. If end play exceeds .006" (.16 mm), replace camshaft or bearings.

### VALVE TIMING

Install camshaft with "O" stamped in tooth on outside of camshaft gear between two teeth with punch marks on crankshaft gear.

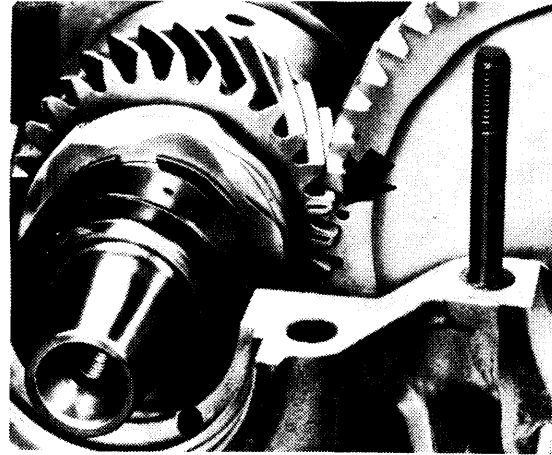

Fig. 12 Position of Camshaft Timing Gear

## ENGINE OILING

**Oil Capacity** — 3.15 qts. Add .5 qt. with filter change.

**Oil Pressure** — 42 psi at 2500 RPM with engine at 158°F.

**Oil Filter** — Full flow oil filter.

**Pressure Regulator Valves** — Oil pressure relief valve, used to protect oil cooler from excessive pressure, is located in crankcase under oil filter. Oil pressure control valve, used to control oil pressure to bearings, is located in crankcase below oil breather. Oil pressure relief spring should have length of 1.75" (.44.1 mm) at 12.3-16 lbs (5.6-7.3 kg) load. Oil pressure control valve spring should have length of .813" (20.6 mm) at 6.8-8.4 lbs. (3.103.8 kg) load.

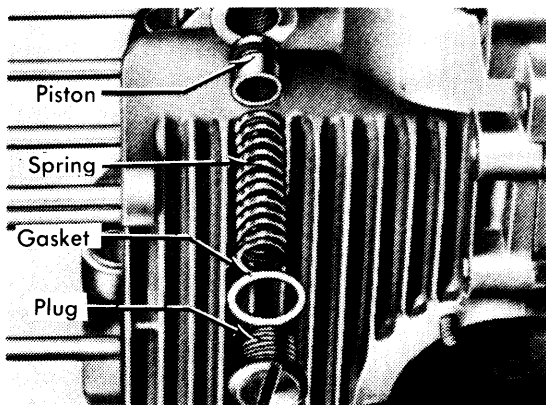

Fig. 13 Expanded View of Relief Valve Components

### ENGINE OILING SYSTEM

Full pressure lubrication system utilizing a gear-type oil pump and installed in rear of engine and driven by camshaft. Oil is pumped through oil filter, oil cooler and into main oil

passages in crankcase. Crankshaft main and connecting rod journals are oiled through cross-drilled oil passages in the crankcase. Oil is pumped to camshaft through oil passages that also lubricate valve tappets. Oil flows through push rods to lubricate rocker arms and shafts. Valve stems are lubricated by splash oil from rocker arms. Excess oil flows back into crankcase through push rod tubes. Cylinder walls and piston pins are lubricated by splash oil.

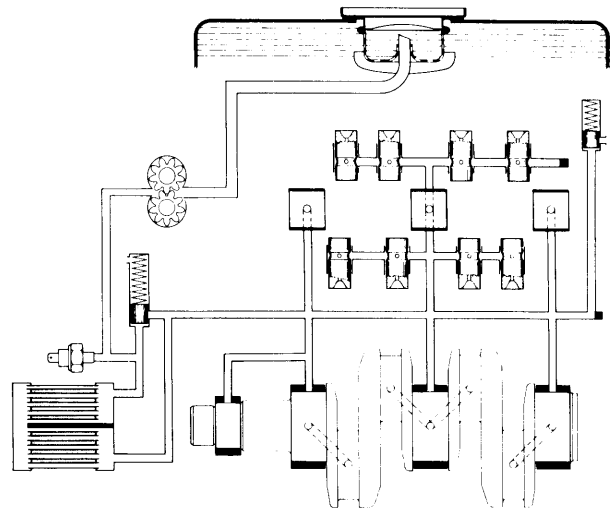

Fig. 14 Distribution of Oil for Engine Lubrication

### OIL COOLER

To remove oil cooler, remove cooling air fan housing, three 6 mm nuts with washers attaching oil cooler to rear of crankcase, and bolts attaching oil cooler support strap. Remove support strap and oil cooler as unit. Always use new rubber seals when installing oil cooler.

## TYPE 2 2000 cc 4 CYLINDER (Cont.)

## ENGINE OILING (Cont.)

## OIL PUMP

**Removal** — Remove engine. Remove 4 nuts holding oil pump. Using puller VW803 (or equivalent) as shown in Fig. 15, pry oil pump out of crankcase.

**Inspection** — Check housing for excessive wear, mainly in gear seating portions. Measure gear backlash for wear. Backlash must not exceed .008" (.20 mm). Replace bearing plate if scored.

**Installation** — Hand turn oil pump drive shaft until fully engaged in camshaft. Rotate crankshaft two revolutions. Pump plate should now be aligned with camshaft. Refit new gasket and reverse removal procedure for remaining components.

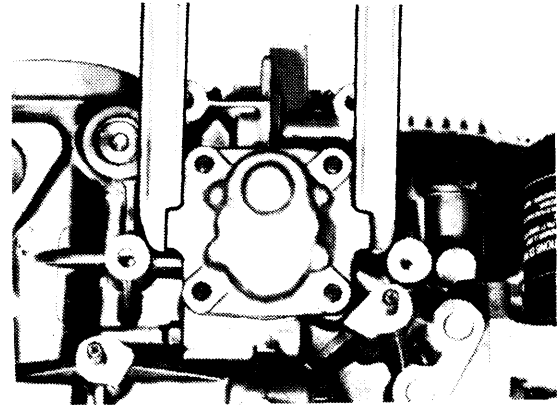

Fig. 15 Using Special Tool (Puller) to Remove Oil Pump

## ENGINE COOLING

**Thermostat** — Opens at 150-160°F (65.6-71.1°C).

## COOLING SYSTEM

Engine is cooled by a radial blower mounted to rear end of crankshaft. Blower draws air through opening in blower shroud at rear of engine. Blower shroud is two-piece unit, mounted around blower and attached to crankcase. As air is drawn in, it is directed over finned cylinders and cylinder heads by deflector plates. A thermostat is mounted under No. 1 and No. 2 cylinders and actuates flaps mounted in shroud to control volume of air directed in deflector plates. As engine warms up, thermostat opens flaps completely to allow total flow of air.

## BLOWER SHROUD REMOVAL

1) Remove engine as previously outlined. Remove air injection pump, belt, and adjusting bracket. Remove extension shaft with pulley, ignition timing scale, fan with crankshaft pulley and alternator belt.

2) Disconnect cooling air control cable from control flap shaft. Pull rubber elbow for alternator out of front half of blower shroud. Remove four nuts attaching blower shroud to crankcase and pull assembly to rear and off engine. To install, reverse removal procedure. Adjust air flap control cable by pushing flaps into closed position and tighten cable.

3) Disconnect flap actuating cable from control shaft. Remove nuts securing shroud to crankcase and remove both halves of blower shroud.

4) To install, reverse removal procedure. Adjust air flap control by pushing flaps into closed position and tighten cable control. Attach elbow for cooling alternator to fan shroud front half.

5) Install drive belt and tighten alternator into proper belt tensioning position (maximum 0.6" deflection). Install cover plates and engine as previously outlined.

## TIGHTENING SPECIFICATIONS

Application	Ft. Lbs. (mkg)
Connecting Rod Nut.....	24 (3.32)
Crankcase Half Nuts (8 mm) .....	14 (1.94)
Crankcase Half Sealing Nuts (10 mm).....	25 (3.46)
Cylinder Head Nuts .....	23 (3.18)
Rocker Shaft-to-Cylinder Head Nuts .....	10 (1.38)
Heat Exchanger-to-Cylinder Head .....	16 (2.21)
Oil Pan-to-Crankcase Nuts.....	9 (1.24)
Drive Plate-to-Crankshaft .....	65 (8.99)
Hub-to-Crankshaft Bolt.....	23 (3.18)
Fan-to-Hub .....	14 (1.94)
Extension Shaft & Pulley-to-Fan.....	14 (1.94)
Engine-to-Transmission .....	22 (3.04)
Oil Pump-to-Crankcase .....	14 (1.94)
Oil Cooler-to-Crankcase .....	14 (1.94)
Flywheel-to-Crankshaft.....	80 (11.06)
Clutch-to-Flywheel .....	18 (2.49)
Torque Converter-to-Driveplate .....	14 (1.94)