

## RX-3, RX-4 & COSMO

GENERAL SPECIFICATIONS								
Engine	cu. ins.	cc	Carburetor	HP at RPM	Torque (Ft. Lbs. at RPM)	Compr. Ratio	Rotor Housing Width	
							in.	mm
RX-3	35	573	4-Bbl.	.....	.....	9.4-1	2.7559	70
RX-4 & Cosmo	40	654	4-Bbl.	.....	.....	9.2-1	3.150	80

① — Displacement per rotor (multiply by 2 for total).

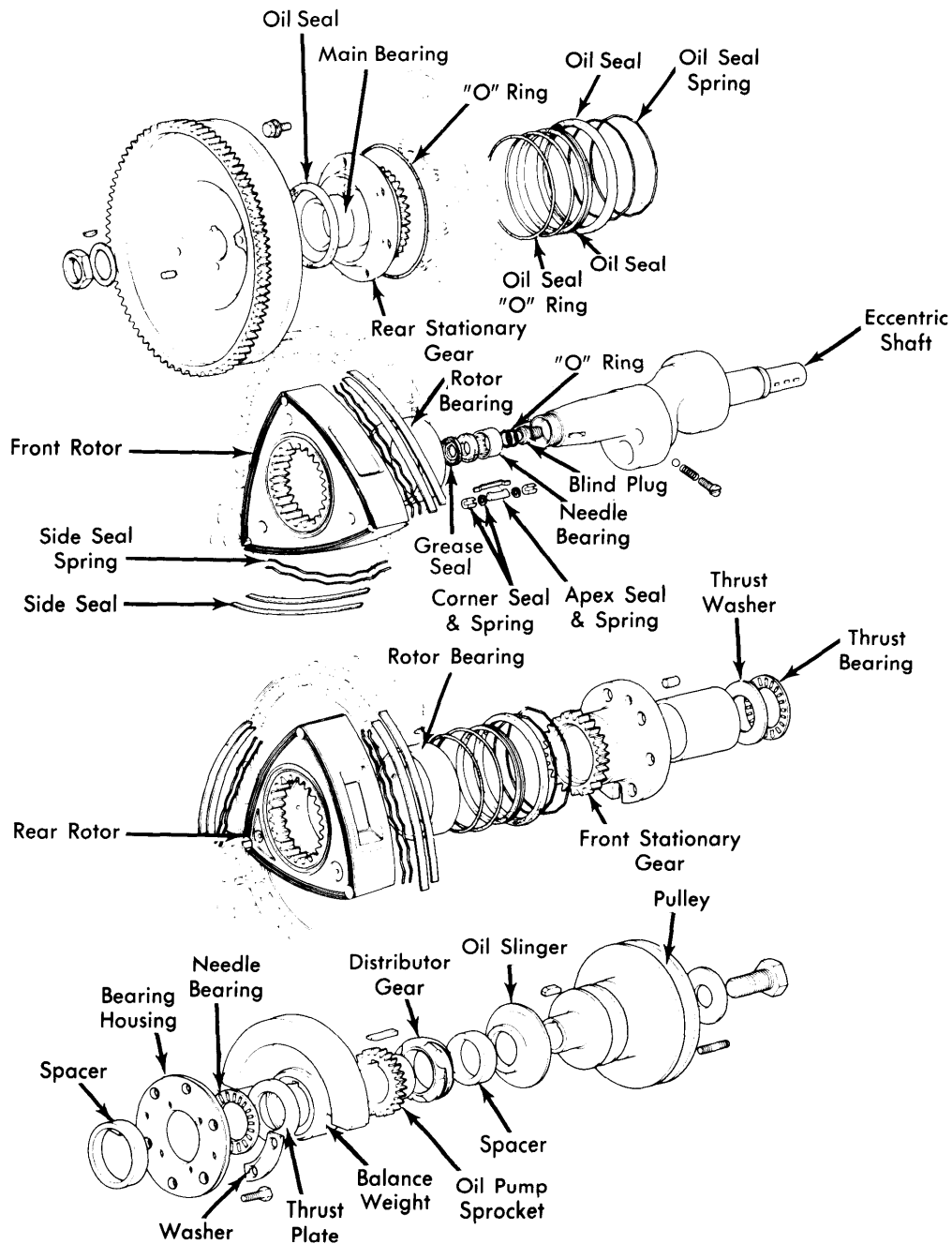

Fig. 1 Exploded View of Rotors & Eccentric Shaft Assembly

## RX-3, RX-4 &amp; COSMO (Cont.)

## ENGINE IDENTIFICATION

Engine identification number is stamped on the front engine housing behind the distributor. Engines are identified with code numbers as follows:

## Engine Codes

Application	Code
RX-3 .....	12A
RX-4 & Cosmo .....	13B

## ENGINE REMOVAL

1) Disconnect negative battery cable and drain cooling system and engine oil. Disconnect primary wiring coupler and high tension wires from ignition coils. Disconnect wire at "B" terminal of alternator and remove coupler from rear of alternator. Disconnect coupler from vacuum control valve (manual transmission).

2) Disconnect bullet connector from choke heater lead of carburetor. Remove couplers from water temperature switch, vacuum switch (automatic transmission), A/C solenoid valve, and from deceleration control valve.

3) Remove connector from EGR solenoid (California). Disconnect couplers to transmission at rear of engine, from oil thermo sensor (except California), and from oil level sensor lead. Disconnect connector from water temperature gauge unit.

4) Remove positive cable from "B" terminal and ignition switch wire from "S" terminal of starting motor. Disconnect vacuum sensing hose from No. 2 vacuum switch (California). Remove air cleaner assembly. Pull couplers from idle switch and air control valve. Disconnect coupler from richer solenoid (manual transmission) and from power valve solenoid

5) Remove fuel line and fuel return line from carburetor. Disconnect accelerator and choke cables from carburetor. Remove sub-zero starting assist hose (except California). Disconnect vacuum sensing hose from vacuum line (automatic transmission), and vacuum sensing line for power brakes from inlet manifold.

6) Disconnect air hose to heat exchanger at inlet manifold. Remove A/C compressor, cooling fan and fan drive assembly. Remove upper and lower radiator hoses. Disconnect automatic transmission fluid lines at radiator. Disconnect heater hoses from radiator and rear housing and hoses from oil cooler. Remove expansion tank cap and radiator.

7) Remove secondary air line from heat exchanger to thermal reactor and pipe from exchanger to inlet manifold. Disconnect exhaust pipe from thermal reactor and remove gasket. Remove exhaust pipe hanger from transmission bracket. Remove clutch release cylinder from clutch housing. Remove starting motor. Remove transmission-to-engine bolts, while supporting transmission with suitable jack.

8) Remove nuts from right and left engine mounts. Install lifting sling on engine hanger brackets and hoist slightly to take up slack. Pull engine forward until it clears clutch shaft. Lift engine from vehicle.

9) To install engine, reverse removal procedure.

## ENGINE DISASSEMBLY

**NOTE** — To simplify engine disassembly, manufacturer recommends use of a special engine stand (49 0839 000 or 49 0107 680A) and special hanger (49 1114 005) for supporting the front housing. See Fig. 2 Also note that this front housing support may be used on previous engines (where rear housing support units were previously used).

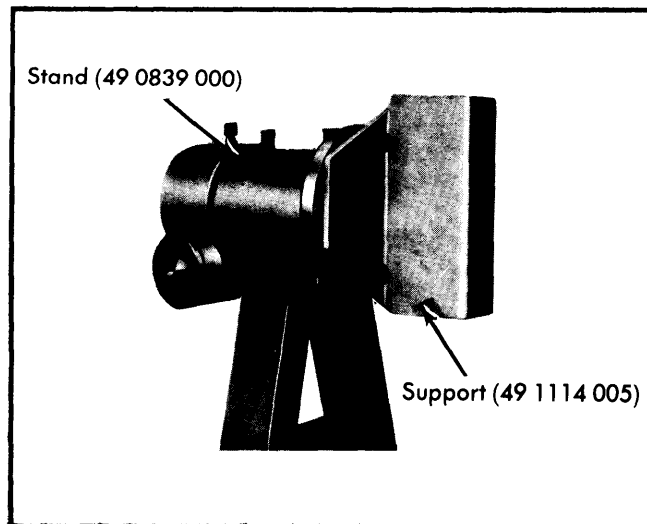

Fig. 2 Engine Stand & Hanger-Support

1) Remove oil hose support bracket from front housing, then mount engine on stand and front housing support. Remove engine hanger bracket from front cover. Disconnect vacuum hoses, air hoses and wiring. Remove deceleration valve and vacuum control valve. Remove air pump and drive belt. Remove alternator and belt.

2) Disconnect metering oil pump connecting rod and oil tubes. Remove inlet manifold and carburetor as an assembly. Remove manifold gasket and "O" rings. Remove thermal reactor (exhaust manifold), distributor, engine mounts and oil filter assembly. Remove eccentric shaft pulley for compressor.

**NOTE** — On engines equipped with manual transmission, attach braking tool (49 1881 060) to flywheel. On engines with automatic transmission, attach stopping tool (49 1881 055) to counterweight.

3) Remove water pump and gasket. Invert engine on stand and remove oil pan, gasket and strainer with gasket.

**NOTE** — When removing oil pan, pry upward using two screwdrivers, one on each side of oil pan and just in front of tapered corners on flywheel end.

4) Mark front and rear housings for installation in their original positions. Return engine to upright position. Unscrew eccentric shaft pulley bolt and remove pulley.

**NOTE** — On engines equipped with manual transmission, attach braking tool (49 1881 060) to flywheel. On engines with automatic transmission, attach stopping tool (49 1881 055) to counterweight.

## RX-3, RX-4 & COSMO (Cont.)

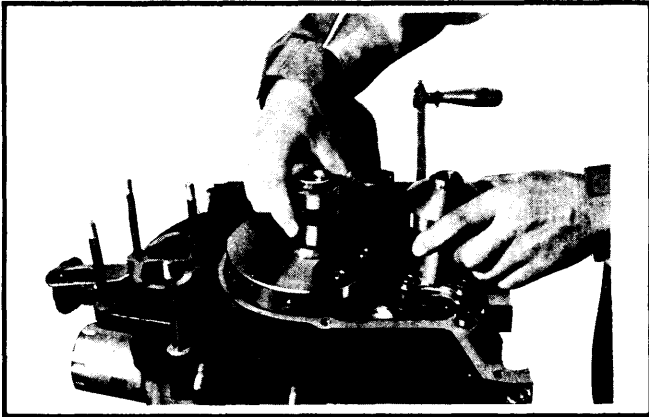

Fig. 3 Removing Sprockets & Chain from Engine

5) Turn engine so that front end is up. Remove front cover with gasket. Remove "O" ring from oil passage on front housing. Slide distributor drive gear off shaft. Remove chain adjuster. Remove oil pump sprocket lock washer and nut. Slide oil pump sprocket and eccentric shaft sprocket and drive chain off shafts simultaneously. See Fig. 3. Remove keys from shafts. Slide balance weight, thrust washer and needle bearing off shaft.

6) Remove bearing housing, needle bearing, spacer and thrust plate from shaft. Remove oil pump. Return engine to upright position.

**NOTE** — On engines equipped with manual transmission, attach braking tool (49 1881 060) to flywheel. On engines with automatic transmission, attach stopping tool (49 1881 055) to counterweight.

7) Remove clutch cover assembly and clutch disc. Straighten tab on lock washer and remove flywheel nut using special tool (49 0820 035). Remove the flywheel using puller (49 0823 300A or 49 0839 305A).

8) If equipped with automatic transmission, remove counterweight. To do so, remove drive plate. Straighten tab of lock washer and remove counterweight nut using special tool (49 0820 035). Remove counterweight, using puller (49 0839 305A).

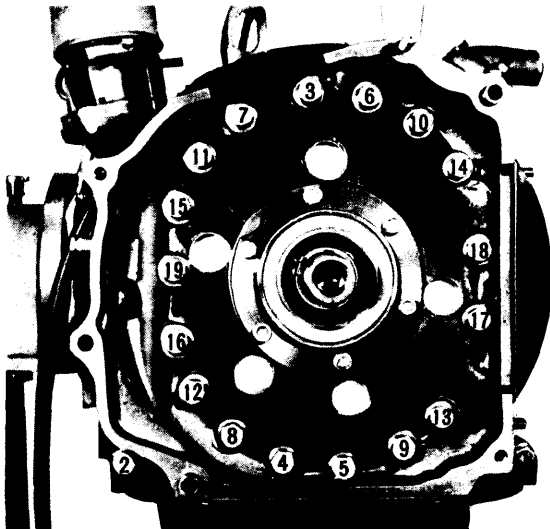

Fig. 4 Loosening Sequence of Tension Bolts

9) Turn rear of engine upward. Loosen tension bolts in sequence shown in Fig. 4, doing so in two or three steps. Remove bolts and lift rear housing off shaft. Remove any seals stuck to rotor sliding surface of rear housing, and replace them in original positions. Remove and discard two sealing rubbers and two "O" rings from rear side of rear rotor housing.

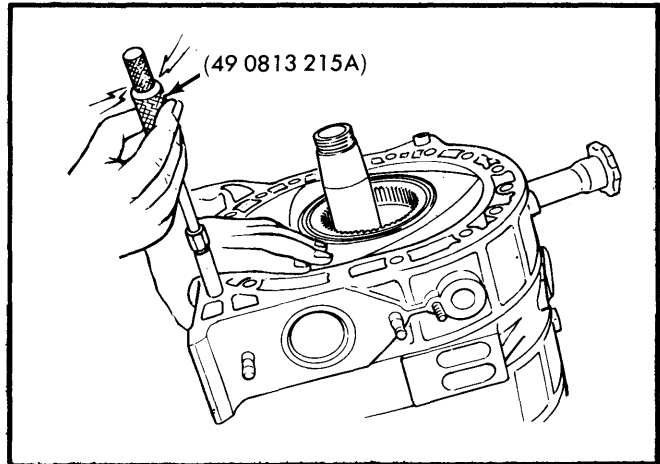

Fig. 5 Extracting Tubular Dowels from Engine

10) Attach dowel puller (49 0813 215A). Pull tubular dowels (See Fig. 5) from rear rotor housing. Hold housing with hand to prevent it from turning or pulling upward. Lift rear rotor housing away from rotor, being careful not to drop apex seals off rear rotor. Remove and discard two sealing rubbers and two "O" rings from front side of rear rotor housing.

11) Remove side pieces, apex seals and springs from rear rotor and store in order for reassembly. Remove all corner seals, corner seal springs, side seals and side seal springs and store in order for later reassembly.

12) Remove rear rotor from eccentric shaft and place it upside down on a clean sheet of cloth. Remove seals and springs from remaining side of rear rotor and store in order for reassembly.

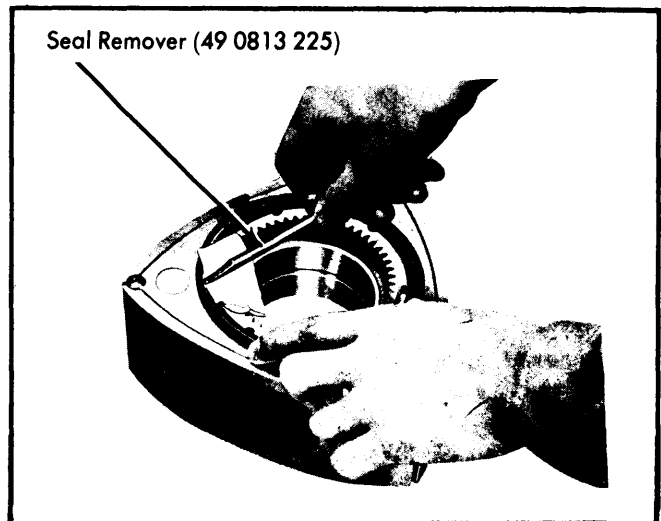

Fig. 6 Prying Oil Seal from Rotor

## RX-3, RX-4 &amp; COSMO (Cont.)

13) Mark each rotor as to front or rear. Remove oil seals from rear rotor using suitable prying tool (49 0813 225), Fig. 6, being careful not to damage oil seal lip.

**NOTE** — Do not exert strong force at any one point in removing seal. Mark rear oil seal springs of each rotor to aid in repositioning them upon reassembly.

14) Holding intermediate housing down by hand, pull tubular dowel from intermediate housing, using dowel puller (49 0813 215A). See Fig. 5. Lift intermediate housing from shaft. To do so, hold housing up off front housing, while helper pushes upward on eccentric shaft. Lift out eccentric shaft.

15) Repeat procedures 10) through 14) to remove front rotor housing and rotor assembly.

## INSPECTION &amp; OVERHAUL

## FRONT, INTERMEDIATE &amp; REAR HOUSINGS

1) To clean front housing, use extra fine emery paper to remove carbon deposits from rotor running surface. Use ketone or thinner to remove sealing agent.

2) Inspect housing for signs of water or gas leakage. Check for wear or damage to rotor running surface or stationary gear. Check main bearings for signs of scoring or flaking.

3) Place a straightedge across housing surface in positions shown in illustration. Using a feeler gauge, measure distortion of front housing. Replace or reface housing if distortion limit of .0016" (.04 mm) is exceeded, (Fig. 7).

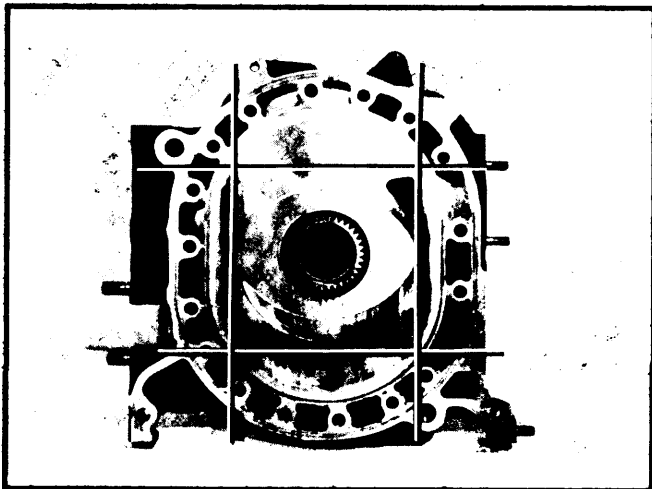

Fig. 7 Straightedge Positions for Checking Housing Distortion

4) Check for wear on rotor sliding surfaces of housing and joint surfaces with rotor housing. Measurements are made using a dial indicator, Fig. 8. If wear exceeds .0039" (.10 mm), reface or replace housing.

**NOTE** — Side housings (front, intermediate and rear housings) can be reused by grinding them, if the required finish can be maintained.

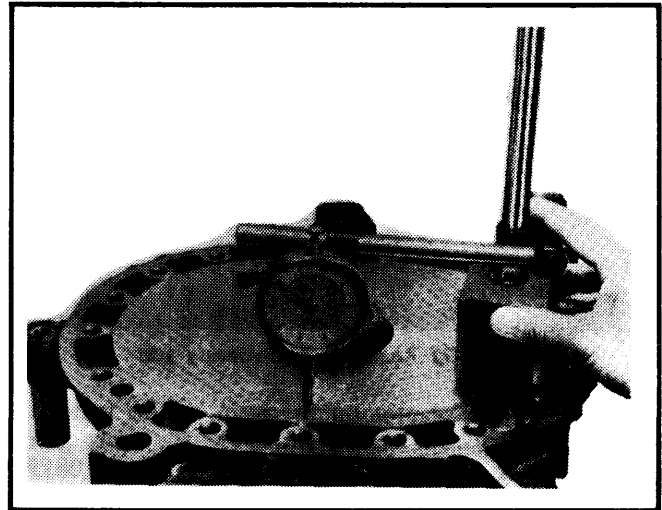

Fig. 8 Measuring Housing Wear with a Dial Indicator

5) Measure inner diameter of main bearing and outer diameter of bearing journal on eccentric shaft. Standard clearance is .0016-.0028" (.04-.07 mm). If clearance exceeds .0039" (.10 mm), replace bearing or eccentric shaft.

6) To replace main bearing, remove stationary gear retaining bolts. Drive stationary gear, with bearing, out of housing using a suitable mandrel (49 0813 235).

7) Place stationary gear in a press, use same mandrel and press main bearing out of stationary gear. Install new bearing while aligning tang of bearing with slot of stationary gear. Press bearing into gear until adapter of mandrel just contacts stationary gear flange. Drive stationary gear into housing with same mandrel. Align dowel pin on housing with slot in gear flange, (Fig. 9). Tighten stationary gear retaining bolts.

**NOTE** — When installing rear main bearing, check condition of "O" ring and replace if necessary. Apply sealing agent on stationary gear flange prior to installing it on rear housing. Align pin and slot.

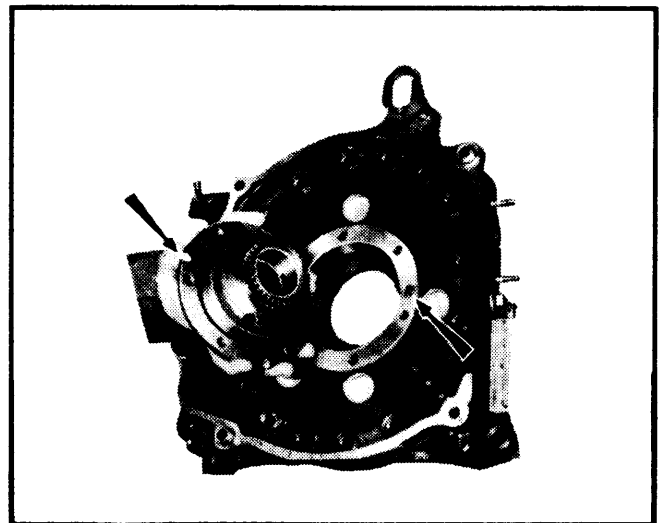

Fig. 9 Stationary Gear Slot & Dowel Alignment

## RX-3, RX-4 & COSMO (Cont.)

ROTOR HOUSING, INTERMEDIATE HOUSING & ROTOR							
Engine	ROTOR HOUSING		INTERMEDIATE HOUSING		ROTOR		
	Width In. (mm)	Distortion Limit In. (mm)	Width In. (mm)	Distortion Limit In. (mm)	Inside Diameter In.(mm)	Housing-to-Rotor Clearance In. mm)	Land Protrusion In. (mm)
RX-3	2.7559 (70)	.0016 (.04)	..... ..... .....	.0016 (.04)	..... ..... .....	.0039-.0083 (.10-.21)	..... ..... .....
RX-4 & Cosmo	3.150 (80)	.0016 (.04)	..... ..... .....	.0016 (.04)	..... ..... .....	.0039-.0083 (.10-.21)	..... ..... .....

### ROTOR HOUSINGS

1) To clean housing, wipe off sealing agent or carbon in rotor running surface with a rag and ketone or thinner. Remove rust deposits in water cooling passages.

2) Inspect for cracks or damage to chromium plated surface. Check for signs of gas or water leakage. Housing must be replaced if any of these conditions exist.

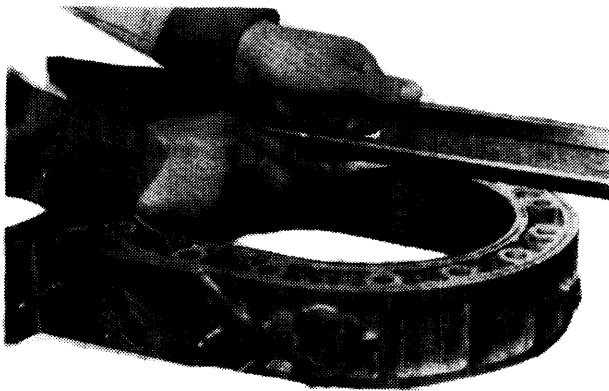

Fig. 10 Measuring Rotor Housing for Distortion

3) Place a straightedge across sealing surface of rotor housing and check for distortion, using a feeler gauge. If distortion exceeds .0016" (.04 mm), replace housing. See Fig. 10.

4) Check rotor housing thickness at points A, B, C, and D in Fig. 11. If micrometer readings vary between point A and minimum value for B, C, and D by more than .0024" (.06 mm), replace rotor housing.

**NOTE** — This excessive clearance would indicate a possibility of gas or water leakage.

### ROTORS

1) Combustion condition of rotor can be determined by analyzing color of combustion area before cleaning. General color of combustion area should be brown.

2) Combustion is correct if leading side area of rotor combustion area is brown and trailing side is a blackish color. Check side surface of rotor for signs of gas leakage.

3) Inspect oil seals and replace if necessary. Remove carbon from rotor with fine emery paper. Remove carbon from seal grooves with a carbon remover. Wash rotor in a cleaning solution and blow dry, with compressed air. Inspect rotor for wear

or damage and check internal gear for cracking or chipped teeth.

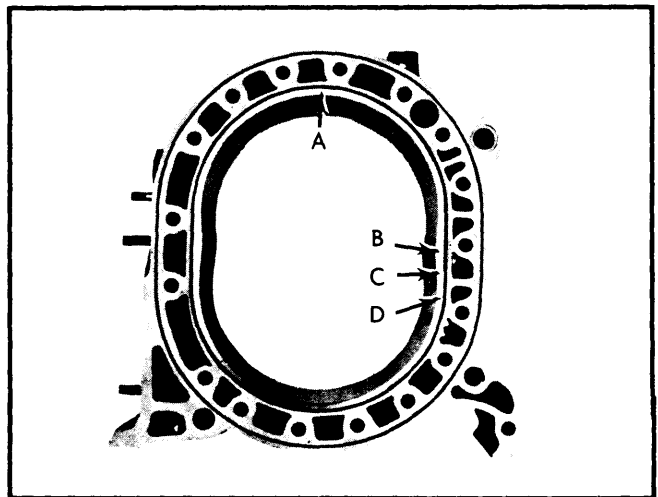

Fig. 11 Rotor Housing Thickness Check Points

4) Measure width of rotor at three points around edge. Subtract maximum rotor width from width of rotor housing at point A, (Fig. 11). Difference should be within .0039-.0083" (.10-.21 mm). If clearance is excessive, replace rotor assembly. If less than specified, internal gear has probably come out. Strike internal gear lightly with plastic hammer and remeasure clearance.

5) Measure inner diameter of rotor bearing and outside diameter of rotor bearing journal on eccentric shaft. Replace rotor bearing if clearance exceeds .0039" (.10 mm). See Rotor Bearing Replacement.

OIL SEAL		
Height In. (mm)	Seal Lip Contact Width	
	Standard In. (mm)	Limit In. (mm)
.220 (5.6)	.008 (.2)	.031 (.8)

### ROTOR OIL SEAL

With oil seal installed in rotor, measure contact lip width of seal. Seal must be replaced if contact width exceeds .031" (.8

## RX-3, RX-4 & COSMO (Cont.)

mm). Measure seal protrusion (See Fig. 12) and replace seal spring if protrusion is less than .020" (.5 mm).

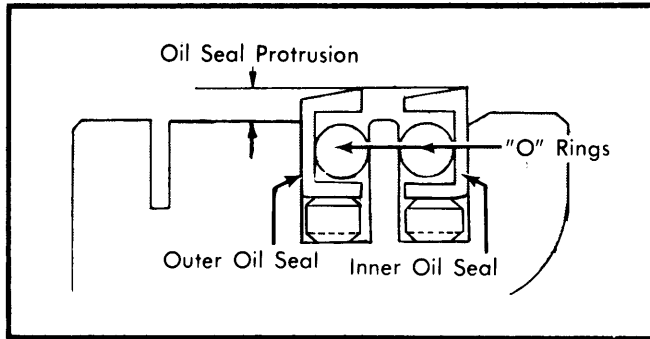

Fig. 12 Measuring Point of Oil Seal Protrusion

without adapter ring, press bearing out of rotor, (Fig. 13). Clean bearing bore with emery paper if necessary. Place rotor on support with internal gear upward. Place a new rotor bearing so slot in rotor bore is in line with bearing lug. Press new bearing (using tool without adaptor), until bearing is flush with rotor boss.

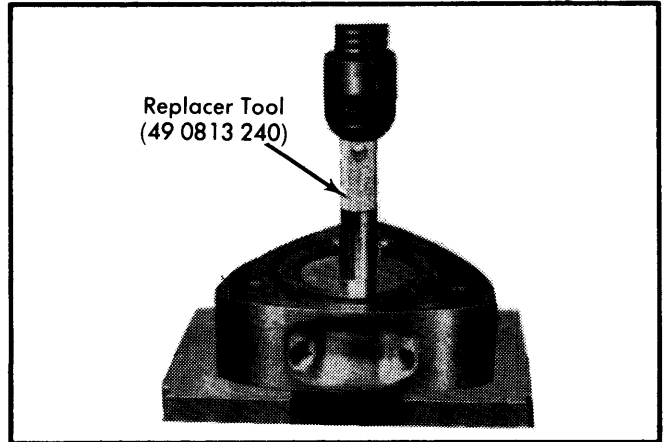

Fig. 13 Pressing Rotor Bearing from Rotor

### ROTOR BEARING REPLACEMENT

Place rotor bearing on support so internal gear is facing downward. Using rotor bearing replacer (49 0813 240)

APEX SEAL							
Engine	Length In. (mm)	Seal Width In. (mm)	Height In. (mm)	Seal-to-Housing		Seal-to-Rotor	
				Clearance In. (mm)	Wear Limit In. (mm)	Groove Clearance In. (mm)	Wear Limit In. (mm)
RX-3	2.7500 (69.85)	.1181 (3)	.335 (8.5)	.0051-.0067 (.13-.17)	.0012 (.30)	.0020-.0035 (.051-.089)	.006 (.15)
RX-4 & Cosmo	3.1438 (79.85)	.1181 (3)	.335 (8.5)	.0051-.0067 (.13-.17)	.0012 (.30)	.0020-.0035 (.051-.089)	.006 (.15)

### APEX SEAL

1) Clean all carbon from apex seal and spring with a cleaning solution (not emery paper). Measure height of apex seal with a micrometer (see illustration). Replace seal if height is less than .275" (7.0 mm).

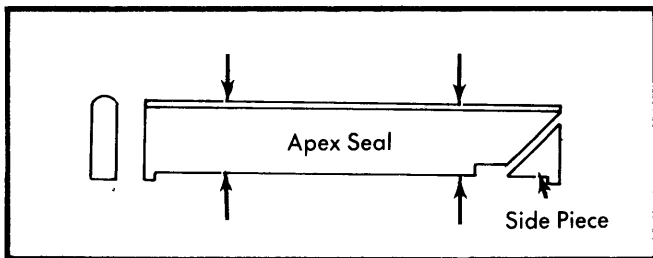

Fig. 14 Measuring Apex Seal Height

2) Check gap between apex seal and groove. To check gap, place apex seal in its respective groove on rotor and measure gap between apex seal and groove with a feeler gauge. Feeler gauge should be inserted until tip of gauge reaches bottom of groove. Standard clearance is .0020-.0035" (.05-

.09 mm). If gap exceeds wear limit of .0059" (.15 mm), replace apex seal.

3) When installing new apex seal, check gap between seal and side housing. Measure length of seal with micrometer and subtract length from rotor housing width at point A, (Fig. 11). Clearance should be .0051-.0067" (.13-.17 mm). If seal length is excessive, correct with emery paper.

4) Be sure free height of apex seal spring (Fig. 15), is at least .22" (5.5 mm) on RX-3 models and .15" (3.8 mm) on other models.

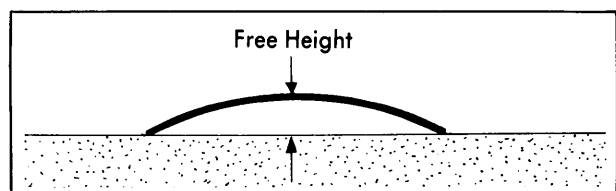

Fig. 15 Measuring Free Height of Apex Seal Spring

## RX-3, RX-4 & COSMO (Cont.)

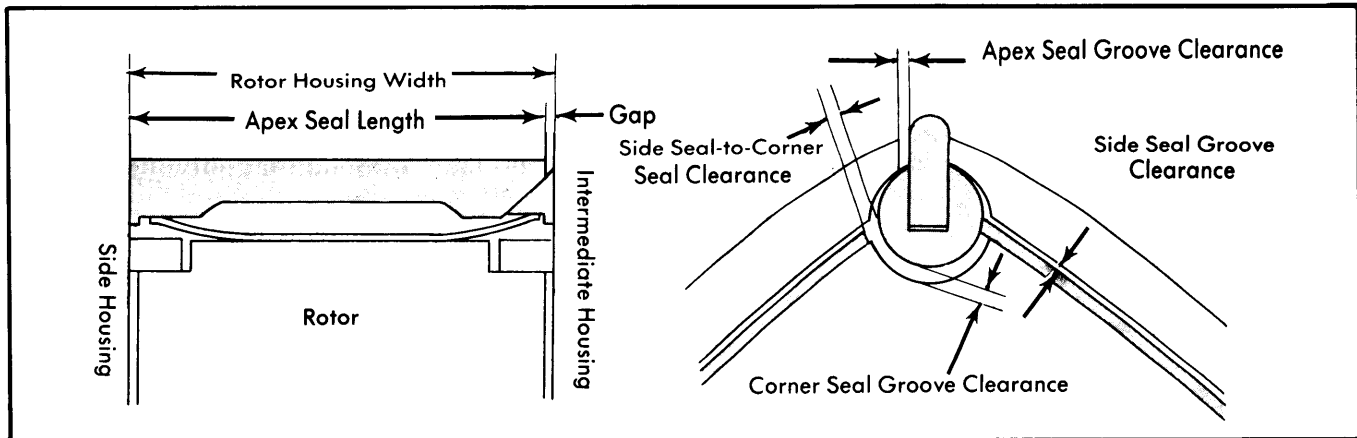

Fig. 16 Measuring Clearance of Apex, Side & Corner Seals

SIDE SEAL						
Engine	Thickness In. (mm)	Width In. (mm)	Seal-to-Groove		Side Seal-to-Corner Seal	
			Clearance In. (mm)	Limit In. (mm)	Clearance In. (mm)	Limit In. (mm)
All	.039 (1)	.138 (3.5)	.0016-.0028 (.04-.07)	.004 (.10)	.0020-.0059 (.05-.15)	.016 (.40)

### SIDE SEAL

1) Remove all carbon from side seal and spring. Check side seal protrusion from rotor surface, and confirm free movement by pressing with finger. Protrusion should be more than .02" (.5 mm). Check gap between side seal and groove with a feeler gauge. Standard gap is .0016-.0028" (.04-.07 mm). If wear limit of .004" (.10 mm) is measured, replace side seal.

2) Check gap between side seal and corner seal with seals installed on rotor. Insert feeler gauge between end of side seal (against rotating direction of rotor) and the corner seal. If gap exceeds .016" (.4 mm), replace side seal.

3) When side seal is replaced, adjust gap between side seal and corner seal by grinding one end of side seal along round shape of corner seal, using a fine file. Make gap .002-.006" (.05-.15 mm).

CORNER SEAL						
Engine	Diameter In. (mm)	Width In. (mm)	Seal-to-Groove		Side Seal-to-Corner Seal	
			Clearance In. (mm)	Limit In. (mm)	Clearance In. (mm)	Limit In. (mm)
All	.433 (11)	.276 (7)	.0008-.0019 (.020-.048)	.0031 (.08)	.0020-.0059 (.05-.15)	.016 (.40)

### CORNER SEAL

1) Clean carbon from corner seal. Check corner seal protrusion from rotor surface, and check free movement by pressing with finger. Protrusion should be more than .02" (.5 mm).

2) Check gap between corner seal and seal groove. Gap limit is .0031" (.08 mm). A gap this large indicates uneven wear of corner seal groove caused by dirt entering engine (due to damaged or clogged air cleaner).

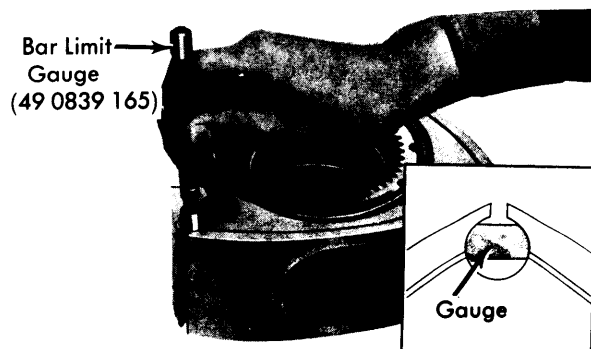

Fig. 17 Checking Corner Seal Groove Measurement

## RX-3, RX-4 &amp; COSMO (Cont.)

3) Extent of corner seal groove wear is determined by using special Bar Limit Gauge (49 0839 165), and is classified according to the following:

**Neither End of Gauge Goes Into Groove** — Indicates that gap conforms to specifications.

**"Go" End of Gauge Goes Into Groove** — Indicates that gap is more than standard, but less than wear limit. In this case replace corner seal, (Fig. 17).

**Both Ends of Gauge ("Go" and "No Go") Go in Groove** — Indicates gap exceeds wear limit of .0031" (.8 mm). Replace rotor.

ECCENTRIC SHAFT MAIN & ROTOR BEARINGS					
Engine	MAIN BEARINGS			ROTOR BEARINGS	
	Journal Diameter In. (mm)	Clearance In. (mm)	Eccentric Shaft Endplay In. (mm)	Journal Diameter In. (mm)	Clearance In. (mm)
All	1.6929 (43)	.0016-.0028 (.04-.07)	.0016-.0028 (.04-.07)	2.9134 (74)	.0016-.0031 (.04-.08)

## ECCENTRIC SHAFT

1) Thoroughly clean eccentric shaft in a suitable cleaning solution and blow out oil passages with compressed air. Inspect shaft for scratching or scoring of bearing journals and possible blocked oil passages.

2) Check rotor bearing clearance by measuring inner diameter of the rotor bearing and outer diameter of the eccentric shaft rotor journal. Clearance should be .0016-.0031" (.04-.08 mm). Replace the bearing if clearance exceeds .0039" (.10 mm). Replace eccentric shaft if journal diameters are under specified limits.

3) Place eccentric shaft in two "V" blocks. Mount a dial indicator and check runout of both ends by rotating shaft slowly. If runout exceeds .0024" (.06 mm), replace shaft.

4) Oil passages in eccentric shaft are sealed by a blind plug in rear of shaft. Inspect plug for possible oil leakage. If leakage is detected, remove plug with an Allen wrench and install new "O" ring. Tighten plug.

5) Inspect needle bearings in end of shaft for wear or damage. Check for spring weakness, stuck, or damaged steel ball at the oil jets. Inspect front needle bearing, bearing housing, and thrust plate for wear or damage. Inspect front and rear oil seals for leaks, replace as necessary.

## ENGINE ASSEMBLY

SEAL SPRINGS		
Engine	Spring	Free Height In. (mm)
RX-3	Apex	.272 (6.9)
RX-4 & Cosmo	Apex	.185 (4.7)
All	Side	.075 (1.9)
	Corner	.098 (2.5)
	Inner Oil	.110 (2.8)
	Outer Oil	.102 (2.6)

## OIL SEALS

1) Place rotor on rubber pad or cloth. Install oil seal springs in their respective grooves on rotors, with each edge of spring fitted in stopper hole. Ensure oil seal springs have been painted in cream or blue color: cream colored springs must be placed on front faces of both rotors and blue springs on rear faces of rotors. When installing, painted side of spring must face oil seal (upward), Fig. 18.

2) Insert new "O" ring in each oil seal. Install inner oil seal to each side of rotor as follows: Position oil seal to groove so square edge of spring fits in stopper notch of oil seal. Press into position by using a used inner oil seal so lip of inner oil seal sinks into position approximately .016" (.4 mm) below surface of rotor.

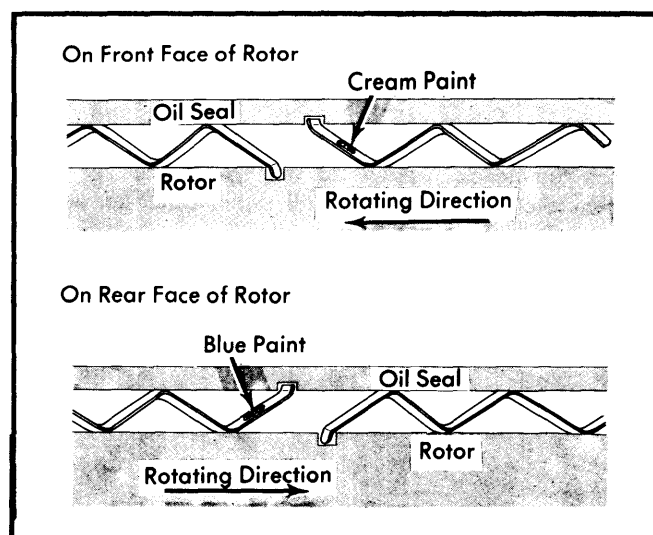

Fig. 18 Installing Oil Seal Springs on Rotor

3) Install outer oil seal so square edge of spring fits in stopper notch of oil seal. Push head of oil seal in position slowly with fingers. **NOTE** — Take care not to deform lip of oil seal. Apply sufficient lubricant to each oil seal and groove, and confirm smooth movement of each seal by pressing head of seals. Check oil seal protrusion. See Rotor Oil Seal Replacement.

## RX-3, RX-4 & COSMO (Cont.)

### APEX, CORNER & SIDE SEALS

**NOTE** — Before installing apex seal, cut the assist piece with a knife to a length of .08-.10" (2.0-2.8 mm). Peel off paper and install assist piece on apex seal, Fig. 19.

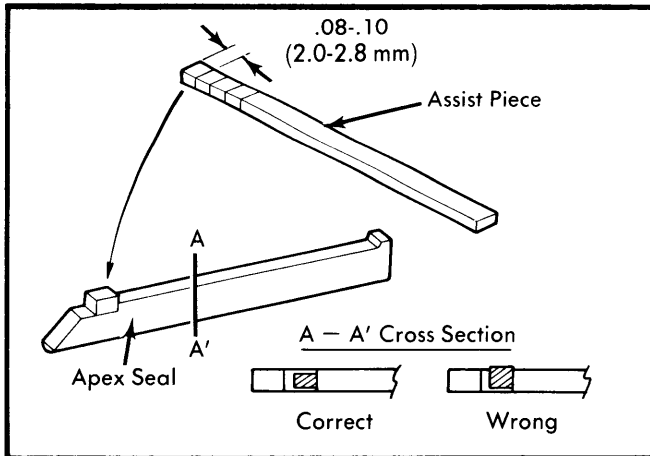

Fig. 19 Installing Assist Piece on Apex Seal

1) Position apex seals, without springs, and side pieces into their respective grooves so that each side piece rests on rear side of each rotor. Place corner seals and springs into their respective grooves, then position side seals and springs in proper grooves.

2) Apply engine lubricant to each spring. Ensure smooth movement of each spring. Check seal protrusion, as described previously. Invert rotor and install seals on other side of rotor.

### INSTALLING FRONT ROTOR

1) Mount front housing on work stand (49 0839 000) and special hanger (49 1114 005). Turn front housing on stand so that top of housing is upward. Apply engine lubricant to internal gear of rotor. Hold apex seals in place by using the old "O" ring and position rotor assembly on front housing. Turn housing so that sliding surface of front housing faces upward.

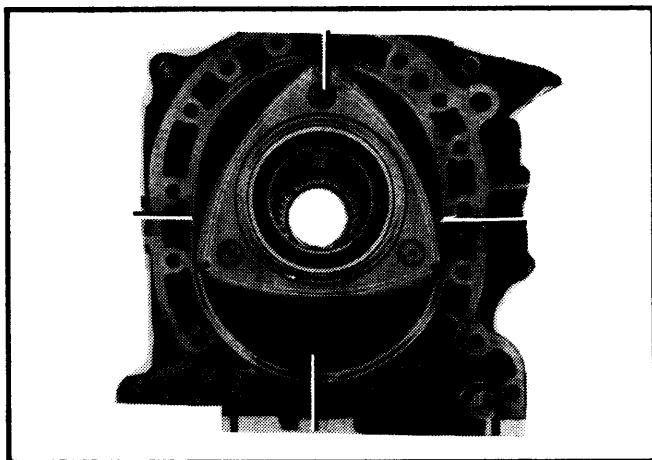

Fig. 20 Positioning Rotor Apex for Reassembly

2) Mesh internal gear and stationary gear so that one of the rotor apices is set to any one of the four positions as illustrated. Remove old "O" ring. See Fig. 20.

**NOTE** — Take care not to drop corner seals into ports.

### INSTALLING ECCENTRIC SHAFT

Lubricate front rotor journal and main journal on shaft with engine lubricant. Insert eccentric shaft being careful not to damage rotor bearing and main bearing.

### INSTALLING FRONT ROTOR HOUSING

**NOTE** — Front and rear rotor housings are not interchangeable. Be sure they are installed in correct sequence.

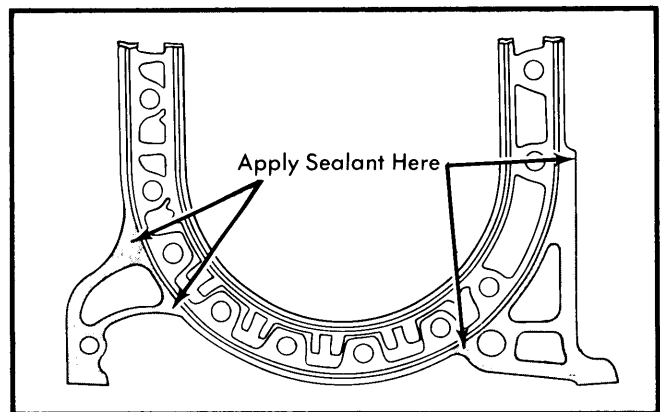

Fig. 21 Applying Sealing Agent to Rotor Assembly

1) Apply sealing agent to front side of front rotor housing in areas shown in Fig. 21. Do not use cooling system sealers.

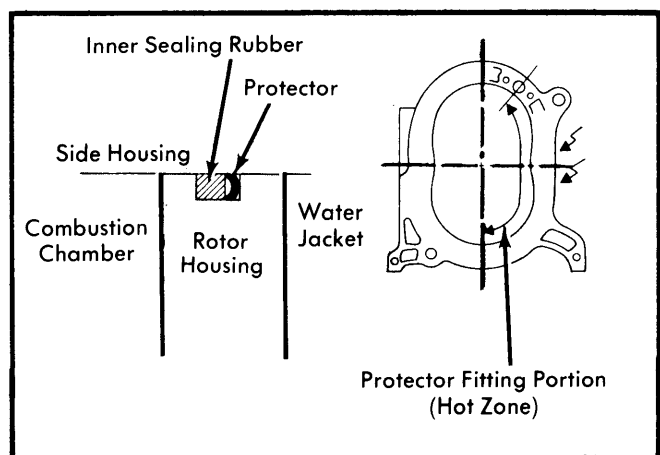

Fig. 22 Installing Protectors for Inner Sealing Rubbers

2) To provide greater durability to sealing rubbers, install a protector behind each inner sealing rubber, (Fig. 22). Install new "O" ring, sealing rubbers and protector in front side of rotor housing. Apply a light coating of petroleum jelly to hold them in place.

## RX-3, RX-4 &amp; COSMO (Cont.)

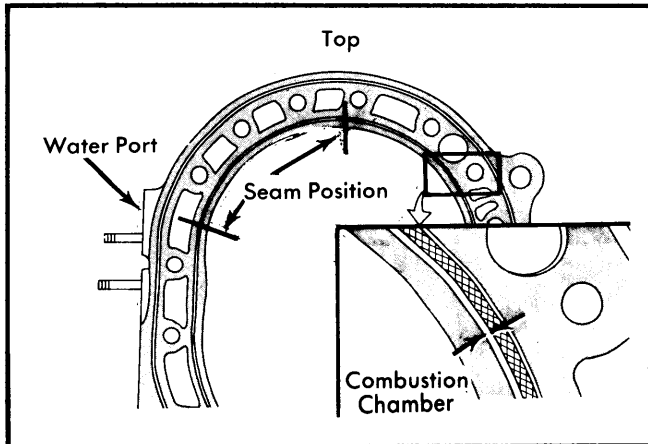

Fig. 23 Positioning Inner Sealing Rubber

**NOTE** — Inner sealing rubber is square type. The wider white line of sealing rubber should face toward combustion chamber and seam of rubber should be placed as shown in Fig. 23. Do not stretch sealing rubbers.

3) Invert front rotor housing, being careful of seals, and install it on front housing. Apply engine lubricant to dowels and insert them through front rotor housing into front housing. Install new "O" rings, sealing rubbers and protector to rear side of front housing.

4) Insert apex seal springs, confirming spring direction, Fig 16. Install corner seal springs and corner seals in their respective grooves. Install side seal springs and side seals. Fit side pieces to their original positions. Apply engine oil to all seals. Apply sealant to rear side of front rotor housing in areas shown in Fig. 21. Apply engine oil to sliding surfaces of front rotor housing.

### INSTALLING INTERMEDIATE HOUSING

Turn front housing and rotor assembly so that top of housing is upward. Pull eccentric shaft outward approximately 1.0" (25 mm), but not more than 1.5" (38 mm). Rotate eccentric shaft until eccentric portion points to 2 o'clock position. Install intermediate housing over eccentric shaft and turn engine so that rear of engine is upward.

### INSTALLING REAR ROTOR & HOUSING

Use same procedures up to *Intermediate Housing* when installing rear rotor and rotor housing.

### INSTALLING REAR HOUSING

Position engine with rear end upward. Apply sufficient lubricant onto stationary gear and main bearing. Install rear housing onto rear rotor housing, and turn rear rotor slightly to engage rear housing stationary gear with rear rotor internal gear.

### TIGHTENING TENSION BOLTS

Place a new sealing washer on each tension bolt and oil threads of each bolt. Refer to illustration and tighten bolts in sequence shown in Fig. 24. Tighten bolts in steps until final

torque setting of 23-27 ft. lbs. (3.2-3.8 mkg) is reached. After tightening, turn eccentric shaft and make sure rotation is light and smooth.

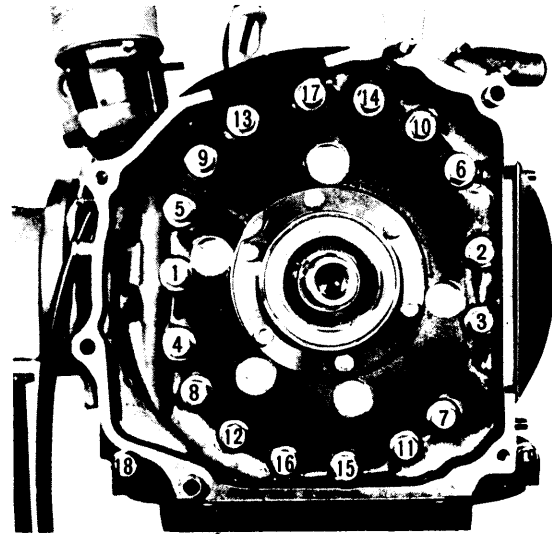

Fig. 24 Tightening Sequence of Tension Bolts

### FLYWHEEL COUNTERWEIGHT INSTALLATION

**With Man. Trans.** — 1) Apply lubricant to oil seal in rear housing. Mount flywheel to rear end of eccentric shaft so that key fits into flywheel keyway. Apply sealing agent to both sides of flywheel lock washer, and place washer in position. Fit lock nut by fingers. Hold flywheel with suitable ring gear brake tool (49 1881 060) and tighten lock nut to 289-362 ft. lbs. (40-50 mkg). Bend up lock tabs on washer.

2) Hold clutch disc in position with clutch disc centering tool (49 0813 310). Mount clutch cover and pressure plate assembly on flywheel and align the "0" marks of clutch cover and flywheel. Install 4 standard and 2 reamer bolts finger tight. To avoid distortion of pressure plate cover, tighten bolts in steps, a few turns at a time, until all are tight. Torque bolts to 13-20 ft. lbs. (1.8-2.7 mkg).

**With Auto. Trans.** — Fit key, lock washer and lock nut on eccentric shaft as described for Man. Trans. vehicles. Hold counterweight with suitable tool (49 1881 055) and tighten lock nut to 289-362 ft. lbs. (40-50 mkg). Bend tab of lock washer and attach drive plate on counterweight.

### ECCENTRIC SHAFT END-THRUST ADJUSTMENT

1) Turn engine so front is up. Install thrust plate with chamfer downward, and slide spacer and needle bearing on eccentric shaft. Lubricate shaft and bearings and install bearing housing.

**NOTE** — If bearing housing has not been removed, use care that center of needle bearing in bearing housing comes to center of eccentric shaft and that spacer is seated to thrust plate.

2) Lubricate and install needle bearing, thrust washer, and balance weight on shaft. Install keys in oil pump and eccentric

## RX-3, RX-4 & COSMO (Cont.)

shaft keyways. Place oil pump drive chain on oil pump sprocket and eccentric shaft sprocket, and install sprockets on shafts.

3) Install key in eccentric shaft. Install distributor drive gear, with "F" mark on gear, facing front of engine. Install eccentric shaft pulley on shaft. Use new washer and tighten pulley bolt to 54-69 ft. lbs. (7.5-9.5 mkg).

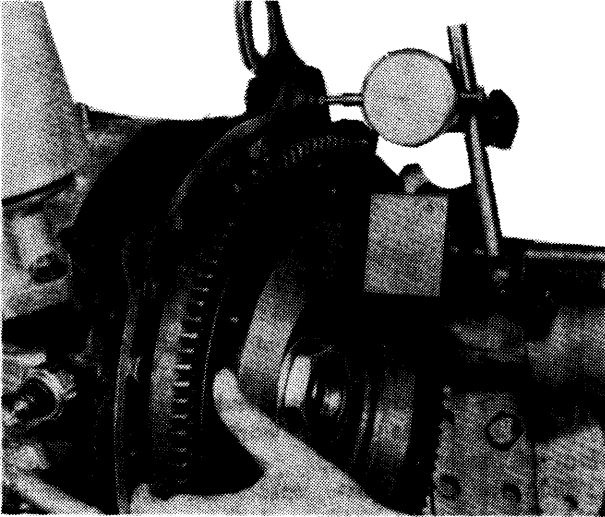

Fig. 25 Measuring Eccentric Shaft End Play with a Dial Indicator

4) Turn engine so top is upward. Attach a dial indicator on the flywheel or counterweight so it contacts rear housing. Move flywheel or counterweight back and forth. Standard end play is .0016-.0028" (.04-.07 mm). If end play is more than .0035" (.09 mm) grind spacer on surface plate with emery paper or install thinner spacer. If end play is less than .0016" (.04 mm), install thicker spacer.

5) Oversize spacers are available in four oversizes from .3181" to .3150" (8.08 mm to 8.00 mm) and are identified by stamped letter "X", "Y", "V", and "Z" respectively. When spacer has been installed, recheck end play.

**NOTE** — If end play is below specified amount, spacer thickness is too small; if end play is beyond specifications, spacer is too thick.

6) When end play is within specifications, remove eccentric shaft pulley and proceed with engine assembly.

### INSTALLING FRONT COVER & ECCENTRIC SHAFT PULLEY

Turn engine so front is upward. Remove eccentric shaft pulley. Tighten oil pump sprocket nut and bend tab of lock washer.

Place chain adjuster in position and tighten attaching nuts. Check that plunger extends .47" (12 mm). (See Fig. 27). If measurement is less, replace adjuster or chain. Install new "O" ring on front housing oil passage and install guide plate over chain adjuster. Install front cover and gasket on front housing. Lubricate oil seal in front cover. Install eccentric shaft pulley, using a new washer. Torque to 54-69 ft. lbs. (7.5-9.5 mkg).

### INSTALLING OIL STRAINER & OIL PAN

Invert engine so bottom of engine is up. Install oil strainer gasket and strainer on front housing. Cut off excess gaskets along mounting surface of oil pan. Apply sealant to joints of each housing. Place gasket and oil pan in position and torque bolts to 5-7 ft. lbs. (.7-1.0 mkg) evenly.

### INSTALLING WATER PUMP

Turn engine upright, position gasket and water pump on front housing and tighten attaching bolts. **NOTE** — For further information on cooling system components, see *Cooling System* in this article.

### INSTALLING DISTRIBUTOR

Rotate eccentric shaft until yellow mark (leading timing mark) on pulley aligns with indicator pin on front cover. Align notch on distributor housing with punch mark on driven gear. Insert distributor so that lock bolt is located in center of its slot; then engage distributor gears. Rotate distributor to the right until contact points close. Then, turn left and stop when contact points just begin to separate. Tighten lock nut and install rotor and cap.

### INSTALLING EXTERNAL COMPONENTS

Install thermal reactor, inlet manifold with carburetor, alternator and drive belt, air pump and drive belt, oil filter assembly and all other external components. Before removing engine from stand, install engine hanger bracket to front cover.

PORT TIMING				
Engine	INTAKE		EXHAUST	
	Open (ATDC)	Close (ABDC)	Open (BBDC)	Close (ATDC)
All	32°	40°	75°	38°

## ENGINE OILING

### Crankcase Capacity

RX-3 — 4.4 quarts without filter change.

RX-4 & Cosmo — 5.3 quarts without filter change.

**Oil Filter** — Full-flow, disposable cartridge-type filter mounted on rear housing.

**Normal Oil Pressure** — 14-54 psi at engine idle speed; 64-79 psi at 3000 RPM.

**Pressure Regulator Valve** — Mounted in rear housing, valve regulates oil pressure at high RPM. Valve opens to release oil

## RX-3, RX-4 &amp; COSMO (Cont.)

## ENGINE OILING (Cont.)

pressure. If oil pressure is less than normal, check regulator valve piston for wear and ensure that spring free length is 1.83" (46.4 mm).

## ENGINE OILING SYSTEM

Engine oiling system is forced circulation utilizing a two rotor type oil pump. Oil pump is mounted on front housing and is chain driven through eccentric shaft. A full-flow oil filter is mounted on rear housing. An oil metering pump, pressure regulator valve and an oil cooler in radiator are also employed.

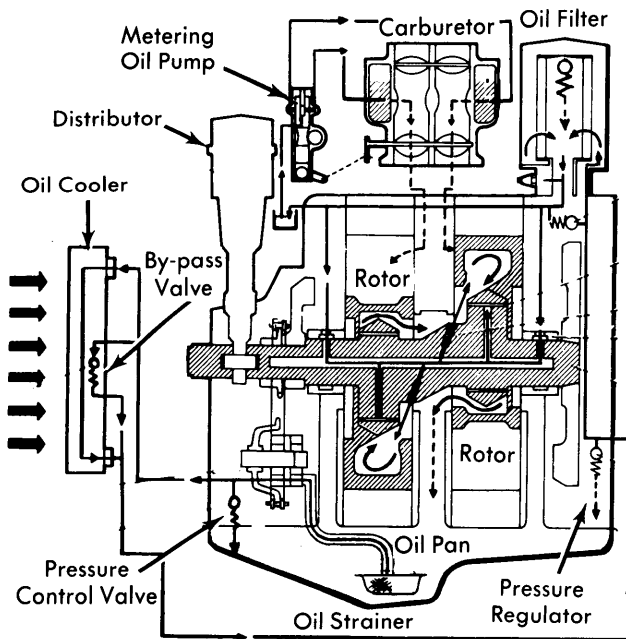

Fig. 26 Cutaway View of Engine Oiling System

## OIL PUMP

**NOTE** — Oil pump is mounted on front engine housing and must be checked or overhauled with front engine cover removed.

1) With front engine cover removed, check chain adjuster. If it extends more than .47" (12 mm) from housing, replace chain or adjuster Fig. 27.

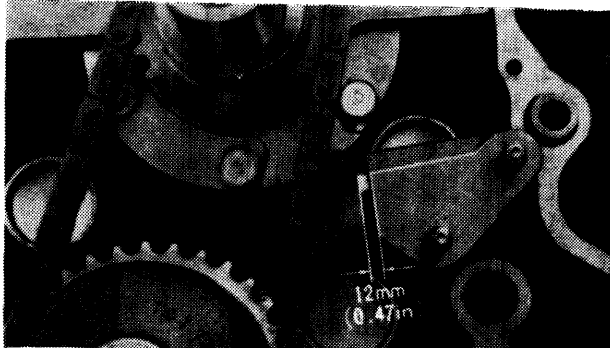

Fig. 27 Measuring Oil Pump Drive Chain Tensioner Extension

2) With oil pump removed, remove snap ring, rear rotors and key from shaft. Remove middle plate lock screw and middle plate.

3) Insert a feeler gauge between lobes of inner and outer rotors and check clearance (Fig. 28). If beyond .006" (.15 mm), replace both rotors.

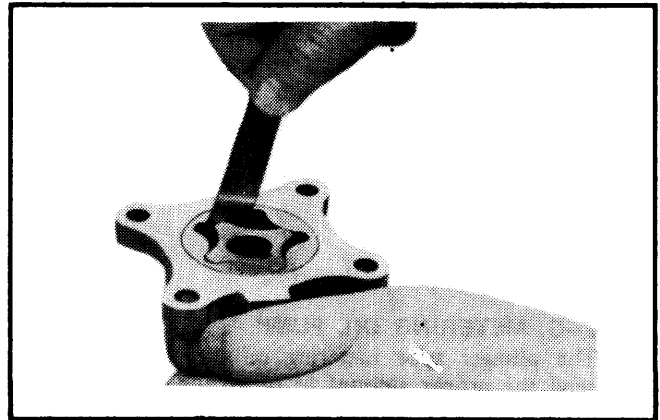

Fig. 28 Measuring Rotor Lobe Clearance

4) Check clearance between outer rotor and pump housing with a feeler gauge. If clearance exceeds .012" (.30 mm), replace rotors or housing.

5) Place a straightedge across pump mounting surface and check rotor end play with a feeler gauge. If beyond .006" (.15 mm), correct pump body or replace rotors.

6) To assemble oil pump, reverse disassembly procedure. Install oil pump and tighten bolts. Install sprockets and chain as previously outlined. See *Eccentric Shaft Endthrust Adjustment*.

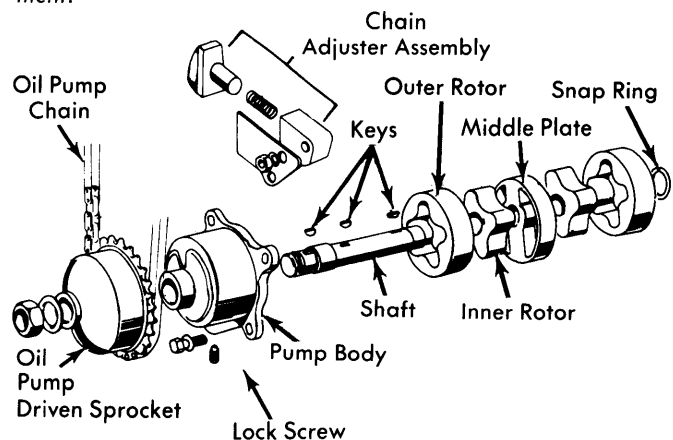

Fig. 29 Exploded View of Oil Pump Assembly

## METERING OIL PUMP

Metering oil pump regulates amount of oil pumped to float chamber of carburetor. The oil enters combustion chamber with air/fuel mixture to lubricate seals within chamber. Amount of oil increases as engine RPM increases and the control lever on metering pump is actuated by a rod connected to

## RX-3, RX-4 & COSMO (Cont.)

### ENGINE OILING (Cont.)

throttle lever. To check amount of oil discharge proceed as follows:

1) Disconnect connecting rod, then disconnect oil lines at carburetor. Start engine and adjust idle to 2000 RPM. Once oil flow from hoses becomes steady, measure volume discharged. Pump should discharge .068-.085 oz. (2.0-2.5 cc) in six minutes.

**NOTE** — As carburetor will not be receiving oil during test, add a small amount of clean oil to carburetor to provide proper lubrication during testing.

2) To adjust oil metering pump, turn the adjusting screw clockwise to increase flow or counterclockwise to decrease flow. One complete turn will change oil discharge flow by .0068 ounces for six minutes of operation. Make sure lock nut of adjustment screw is locked, then recheck metering oil pump discharge rate.

### ENGINE COOLING

**Thermostat** — Wax pellet-type. Starts opening at 187.3-192.7° F (86.5-89.5° C) and is fully open by 212° F (100° C).

#### Cooling System Capacity

RX-3 — 9.9 quarts (9.4 ltr)  
 RX-4 & Cosmo — 10 quarts (9.5 ltr)

#### WATER PUMP

1) Drain cooling system and remove air cleaner. Remove attaching bolts and drive fan. Loosen water pump pulley bolts. Remove air pump and drive belt.

2) Remove alternator and drive belt. Remove water pump pulley bolts and pulley. Remove water pump attaching nuts and bolts, then remove water pump. To install, reverse removal procedure.

### TIGHTENING SPECIFICATIONS

Application	Ft. Lbs. (mkg)
Oil Pump Sprocket .....	22-25 (3.0-3.5)
Oil Pan .....	5-7 (0.7-1.0)
Eccentric Shaft Pulley .....	54-69 (7.5-9.5)
Intake Manifold .....	12-17 (1.6-2.3)
Exhaust Manifold .....	32-43 (4.4-5.9)
Spark Plugs .....	9-13 (1.3-1.8)
Oil Pressure Switch .....	9-13 (1.3-1.8)
Tension Bolts .....	23-27 (3.2-3.8)
Flywheel Lock Nut .....	289-362 (40-50)
Crankshaft Pulley .....	72-87 (10-12)
Water Pump .....	13-20 (1.8-2.7)
Clutch Cover .....	13-20 (1.8-2.7)