

General Motors 6 Engines

250" 6 CYL.

GENERAL SPECIFICATIONS						
Engine	Net HP At RPM	Torque (Ft. Lbs. at RPM)	Compr. Ratio	Bore	Stroke	Displ. Cu. Ins.
250" 1-Bbl.	105@3800	185@1200	8.25:1	3.875"	3.530"	250"

NOTE — Horsepower and Torque figures given above are NET. Net Horsepower and Torque represents power at the flywheel when the engine is installed in a vehicle, with wide open throttle and all systems operating such as; air cleaner, exhaust system, water pump, generator, oil pump and air conditioning.

ENGINE IDENTIFICATION

Engine code is stamped on distributor mounting pad on right side of block and is decoded as follows:

Application	Code
Chevrolet	
Man. Trans. (Federal).....	CCD, CCJ
Auto. Trans. (Federal).....	CCB, CCF
Auto. Trans. (Calif.).....	CCC
Oldsmobile	
Man. Trans. (Federal).....	CCD, CCJ
Man. Trans. (Calif.).....	CCL
Auto. Trans. (Federal).....	CCF, CCH
Auto. Trans. (Calif.).....	CCC
Pontiac	
Man. Trans. (Federal).....	CD
Auto. Trans. (Federal).....	CF
Auto. Trans. (Calif.).....	CC

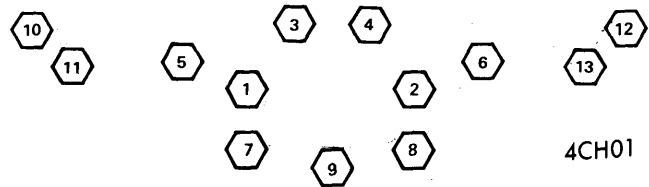

EXHAUST MANIFOLD TIGHTENING SEQUENCE

Installation — To install exhaust manifold, reverse removal procedure. Tighten exhaust manifold bolts in sequence shown in illustration. Tighten all bolts (except 10, 11, 12 and 13) to 30 ft. lbs. Tighten remaining bolts to 20 ft. lbs.

CYLINDER HEAD

Removal — 1) Remove intake and exhaust manifolds as previously outlined. Remove valve cover. Remove rocker arm retaining nuts and remove rocker arm balls, rocker arms and push rods. Mark or identify rocker arms, balls and push rods to ensure that they are installed in original position.

2) Drain cooling system and disconnect fuel and vacuum lines from clip at water outlet and at EFE solenoid. Disconnect leads at temperature sending unit and EFE solenoid. Disconnect upper radiator hose at water outlet. Disconnect battery ground strap at cylinder head and remove coil. Remove cylinder head bolts and remove cylinder head and gasket. Discard gasket.

Installation — Make sure all gasket surfaces are clean. Make sure cylinder head bolt threads and threads in cylinder block are clean. Position cylinder head gasket on cylinder block over dowel pins. Install cylinder head. Coat threads of cylinder head bolts with sealer and install finger tight. Tighten bolts in sequence shown in illustration. To complete installation, reverse removal procedure.

ENGINE REMOVAL

See Engine Removal at end of ENGINE Section.

INTAKE MANIFOLD

NOTE — Some 1976 models may be equipped with intake manifold integral with cylinder head. The following removal and installation procedures apply to models equipped with conventional bolt on intake manifold.

Removal — Remove air cleaner, disconnect throttle controls at bellcrank and remove throttle return spring. Disconnect fuel and vacuum lines at carburetor. Disconnect crankcase ventilation hose at rocker arm and exhaust pipe at manifold. Remove manifold bolts and remove manifold.

Installation — Clean all gasket surfaces on cylinder head and manifolds. Install new gasket and manifold assembly. Tighten all nuts and bolts.

EXHAUST MANIFOLD

NOTE — Following exhaust manifold removal and installation procedures apply to models equipped with integral intake manifold.

Removal — Remove air cleaner, power steering pump bracket and A.I.R. pump bracket (if equipped). Remove EFE valve bracket. Disconnect throttle linkage and return spring. Disconnect exhaust pipe at manifold. Remove manifold retaining bolts and remove manifold.

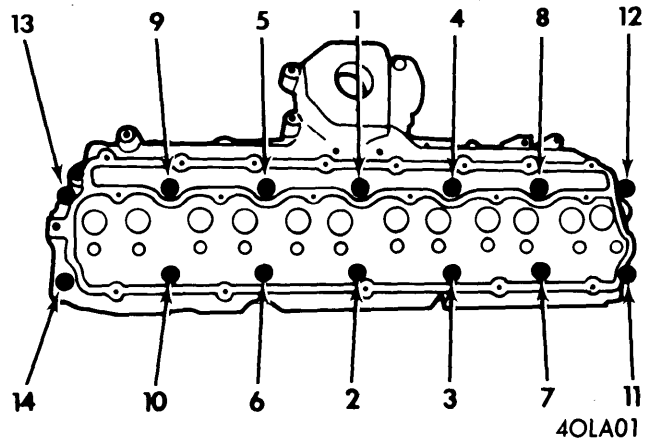

CYLINDER HEAD TIGHTENING SEQUENCE

250" 6 CYL. (Cont.)

VALVES							
Engine & Valve	Head Diam.	Face Angle	Seat Angle	Seat Width	Stem Diameter	Stem Clearance	Valve Lift
250"							
Int.	1.715-1.725"	45°	46°	.031-.063"	.3410-.3417"	.0010-.0027"
Exh.	1.495-1.505"	45°	46°	.063-.094"	.3410-.3417"	⓪.0012-.0027"

⓪ — Specified clearance for Oldsmobile and Pontiac is .0015-.0032".

VALVE ARRANGEMENT

E-I-I-E-E-I-I-E-E-I-I-E

VALVE GUIDE SERVICING

Guides are integral with cylinder head. Valves with oversize stems are available. Ream bores to proper oversize.

VALVE STEM OIL SEALS

"O" ring type used on all valves. Installed on lower groove of valve stem. A light coat of oil on stem will help prevent twisting of oil seal.

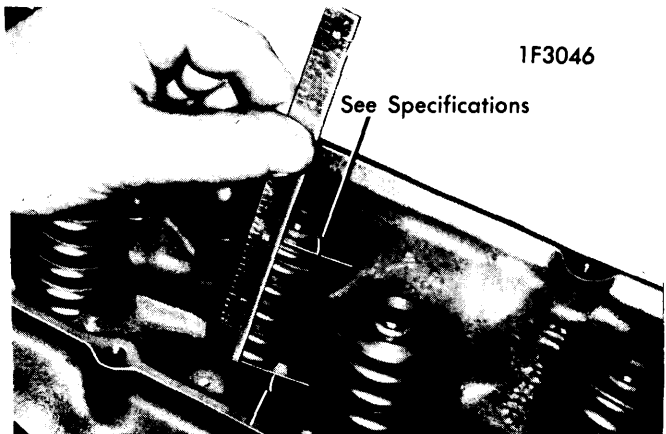

VALVE SPRINGS			
Engine	Free Length	PRESSURE (LBS.)	
		Valve Closed	Valve Open
250"	2.08"	78-86@1.66"	170-180@1.26"

VALVE SPRING INSTALLED HEIGHT

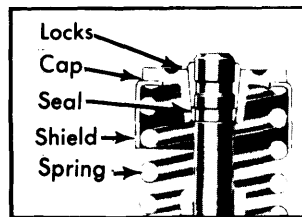

VALVE SPRINGS

Removal — Remove rocker arm cover, spark plug, rocker arm and push rod on cylinder(s) to be serviced. Install air line adapter (J-23590) to spark plug port and apply air to hold valves in place. Using suitable tool (J-5892), compress valve spring and remove valve locks, cap, shield and valve spring. Remove and discard oil seal.

Installation — Before reinstalling old springs, check with a suitable spring tester. Springs should be replaced if not within 10 lbs. of specified load. Set valve spring shield and cap in place on valve stem. Compress spring and install oil seal in lower groove of stem (ensure that seal is flat and not twisted). Install valve locks and release compressor tool. Check that valve locks are properly seated in upper groove of valve stem.



1F3044

VALVE SPRING INSTALLATION

VALVE SPRING INSTALLED HEIGHT

Installed height of valve spring should be $1\frac{1}{32}'' \pm \frac{1}{32}''$. Measure from top of spring seat in head to top of spring or spring shield (see illustration). If measurement exceeds specifications, install $\frac{1}{16}''$ shim at spring seat. Do not shim to obtain a height under minimum specified.

ROCKER ARM STUDS

Studs that have damaged threads or are loose in head should be replaced. Studs are available in oversizes from .001" to .013". Ream hole for oversize studs and coat press area of stud with hypoid axle lubricant. **NOTE** — Do not attempt to install oversize studs without reaming stud hole.

General Motors 6 Engines

250" 6 CYL. (Cont.)

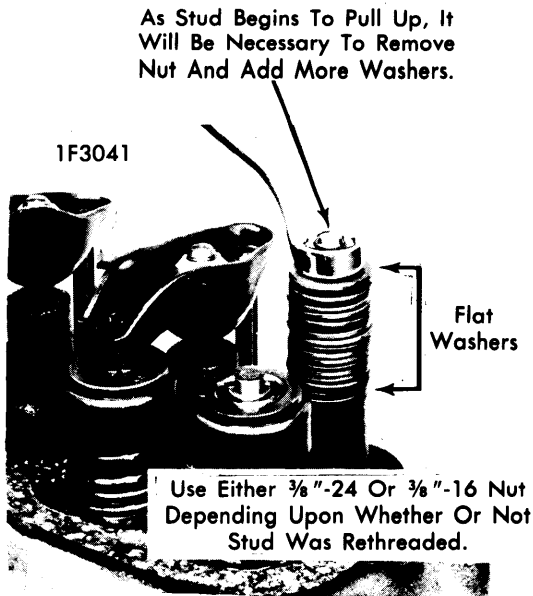

REMOVING ROCKER ARM STUD

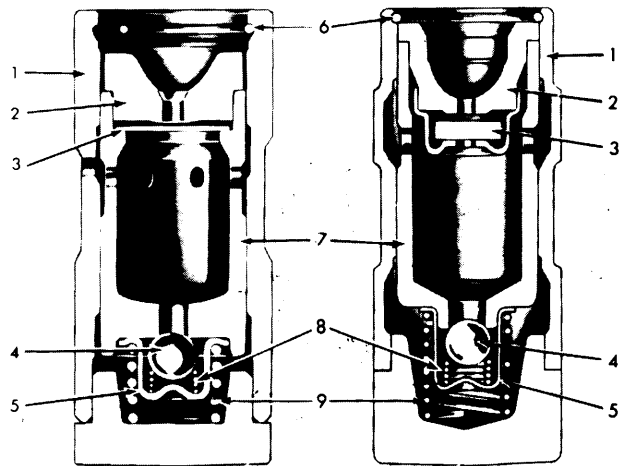
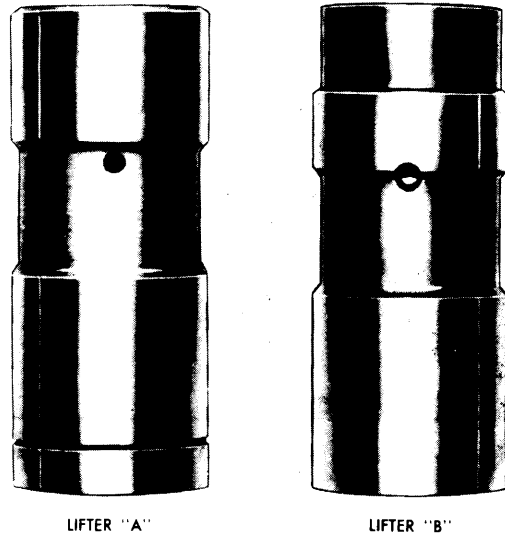

HYDRAULIC VALVE LIFTERS 60L01

- 1 - Lifter Body
- 2 - Push Rod Seat
- 3 - Metering Valve (Lifter "A")
Inertial Valve (Lifter "B")
- 4 - Check Ball
- 5 - Check Ball Retainer
- 6 - Push Rod Seat Retainer
- 7 - Plunger
- 8 - Check Ball Spring
- 9 - Plunger Spring

HYDRAULIC VALVE LIFTER ASSEMBLY

NOTE - Two types of lifters are used, type "A" and type "B" (see illustration). These two types of lifters are interchangeable as complete assemblies only. Lifters are serviced as complete assemblies only. Parts are not interchangeable between lifters. If any component of lifter is worn or damaged, complete lifter must be replaced.

If lifters are disassembled for cleaning and inspection, after reassembly they should be tested using a leak-down tester (follow manufacturers instructions). Before installing lifters, coat bottom of lifter with Molykote.

HYDRAULIC VALVE LIFTER ADJUSTMENT

1) Crank engine until rotor points to No. 1 cylinder position and points are open. Adjust the following valves:

Intake - Nos. 1, 2, 4. **Exhaust** - 1, 3, 5.

Back out rocker arm adjusting nut until lash is felt at push rod, then turn in nut until all lash is removed. When lash is removed, turn adjusting nut in one full additional turn.

2) Crank engine until rotor points to No. 6 cylinder position and points are open. Adjust the following valves:

Intake - Nos. 3, 5, 6. **Exhaust** - Nos. 2, 4, 6.

PISTONS, PINS, RINGS						
Engine	PISTONS		PINS		RINGS	
	Clearance	Piston Fit	Rod Fit	Rings	End Gap	Side Clearance
250"	.0005-.0015"	.00015-.00025"	ⓐ.0008-.0016"	1	.010-.020"	.0012-.0027"
				2	.010-.020"	.0012-.0032"
				3	.015-.055"	.0001-.005"

ⓐ - Interference fit.

250" 6 CYL. (Cont.)

OIL PAN

See Oil Pan Removal at end of ENGINE Section.

PISTON & ROD ASSEMBLY

NOTE — New pistons must be installed in same cylinders for which they were fitted and used pistons in same cylinder from which they were removed.

Removal — With oil pan, oil pump and cylinder head removed, use a suitable ridge reamer to remove any ridge or deposits on upper end of cylinder bore. **NOTE** — Piston must be at bottom of stroke and covered with cloth to collect cuttings. Inspect connecting rods and caps for cylinder identification and mark as necessary. Remove rod cap and install suitable tool on connecting rod studs. Push piston and rod assembly out top of cylinder block.

Installation — Lightly coat pistons, rings and cylinder walls with engine oil. Ensure ring gaps are properly spaced (see illustration) and compression ring has marked side toward top of piston. Install ring compressor on piston. With suitable tool on connecting rod studs, install each piston and rod assembly (notch on piston head towards front of engine) in its respective bore. Guide connecting rod onto crankshaft journal while tapping piston head with hammer handle to seat connecting rod against crankshaft. Remove tool from studs and install mating rod cap. Tighten rod cap nuts.

FITTING PISTONS

Measure cylinder bore diameter 2 1/2" from top of cylinder bore. Measure piston diameter across center line of piston pin. Maximum acceptable clearance is .0025" (used or new piston in worn cylinder bore). Oversize pistons are available in .001" and .030" oversize.

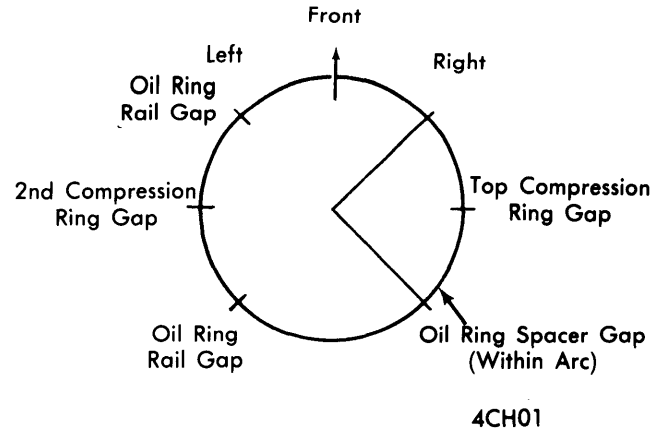

RING GAP LOCATION

PISTON PINS

Piston and piston pin are a matched set and are not serviced separately. Measure diameter of piston pin with a micrometer and measure piston pin bore in piston with a dial bore gauge or inside micrometer. If clearance is greater than .001", piston and pin should be replaced.

Removal — Place piston on suitable support. Using a pilot tool as a driver, use arbor press to push pin from piston and rod.

Installation — Assemble rod to piston with oil hole in rod to right side of piston (notch in piston to be facing forward). Place piston on suitable support and using a pilot tool and arbor press, push pin into assembly. Check piston for freedom of movement on pin.

CRANKSHAFT MAIN & CONNECTING ROD BEARINGS							
Engine	MAIN BEARINGS				CONNECTING ROD BEARINGS		
	Journal Diam.	Clearance	Thrust Bearing	Crankshaft End Play	Journal Diam.	Clearance	Side Play
250"	2.2983-2.2993"	.0003-.0029"	No. 7	.002-.006"	1.999-2.000"	.0007-.0027"	.009-.014"

MAIN & CONNECTING ROD BEARINGS

NOTE — Following procedures are with oil pan and oil pump removed.

Connecting Rod Bearings — After ensuring rod caps are marked for cylinder identification, remove rod caps. Use Plastigage method to check for proper bearing clearances. If not within specifications, new bearings must be installed. New bearings are available in .001", .002", .010" and .020" undersize. Selective fitting is required on each connecting rod. A standard bearing half may be used in combination with a .001" undersize, or a .002" undersize in combination with a .001" undersize. Coat bearing surfaces with oil, install rod cap and tighten nuts.

Main Bearings — 1) Support crankshaft at both front and rear (damper and flywheel) and ensure that all bearing caps, other than one being checked, are tight. Starting with rear main bearing cap and working forward, remove one cap at a time and check bearing clearances using Plastigage method.

2) If clearances are not within specifications, bearings are available in .001", .002", .010" & .020" undersize. One half of a standard size bearing can be used in conjunction with one half of a .001" undersize bearing to obtain proper clearances.

NOTE — Some production crankshafts are ground .009" undersize. A engine fitted with a undersize crankshaft is identified by ".009" stamped on crankshaft counterweight forward of center main journal. A figure "9" will be stamped on block at left front oil pan rail.

3) Remove all main bearing upper halves (except rear main) by inserting suitable tool in oil hole of crankshaft journal and rotating crankshaft clockwise to roll bearing from engine. Oil new upper bearing and insert plain (unnotched) end between crankshaft and indented (or notched) side of block. Rotate bearing into place.

4) To replace rear main bearing upper half, use a small drift punch and hammer to start bearing rotating out of block. **NOTE** — Take care not to nick crankshaft journal. Use a pair of pliers (with taped jaws) to hold bearing thrust surface to oil

250" 6 CYL. (Cont.)

slinger and rotate crankshaft to remove bearing. Oil new bearing and insert plain (unnotched) end between crankshaft and indented (or notched) side of block. Use pliers as in removing to rotate bearing into place.

5) Main bearing caps are to be installed with arrows pointing forward. Tighten main bearing bolts except rear main. Torque rear main bolts 10-12 ft. lbs. and tap end of crankshaft, first rearward, then forward to line up rear main bearing with crankshaft thrust face. Tighten all main bearing cap bolts. Rotate crankshaft to ensure there is no excessive drag.

THRUST BEARING ALIGNMENT

Using a large screwdriver, pry crankshaft toward front of engine. Measure crankshaft endplay at front of rear main bearing using a feeler gauge. If end play exceeds specifications, replace rear main bearing. To align thrust bearing, tighten all main bearing bolts, except rear main bearing. Tighten rear main bearing cap to 10 ft. lbs. Tap end of crankshaft, first forward then rearward, to align thrust bearing. Tighten rear main bearing cap.

REAR MAIN BEARING OIL SEAL

NOTE — Replace upper and lower seal halves as a unit. Install seal with lip facing front of engine. With oil pan and oil pump removed, proceed as follows:

Removal — Remove rear main bearing cap and remove seal from cap. Use a small brass drift punch to tap upper seal until end protrudes far enough to be removed with pliers.

Installation — 1) Coat seal lips and bead with light engine oil, keeping oil off seal mating ends. To replace upper seal, fabricate a tool from .004" shim stock (see illustration). Position tip of tool between crankshaft and seal seat, then position seal between crankshaft and tip of tool so seal bead contacts tip of tool.

2) Roll seal around crankshaft using tool as a "shoehorn" to protect seal bead from sharp corner of seal seat surface. Remove tool, being careful not to withdraw seal.

3) Install lower seal in bearing cap, using tool as a "shoehorn". Feed seal into cap using light pressure with thumb and finger. Apply sealant to bearing cap interface, being careful to keep sealant off seal split line. Install bearing cap and tighten bolts.

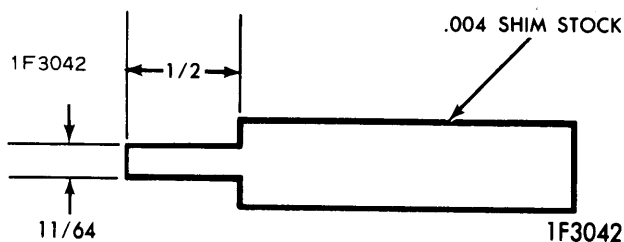

REAR MAIN SEAL INSTALLING TOOL

ENGINE FRONT COVER

Removal — Remove torsional damper and two oil pan-to-front cover bolts. Remove front cover bolts. Pull cover slightly forward and cut oil pan front seal flush with cylinder block at both sides of cover. Remove front cover.

Installation — Clean all gasket surfaces. Cut tabs from new oil pan front seal and install seal to front cover, pressing tips into holes in cover. Coat front cover gasket with sealer and

position on cover. Apply a 1/8" bead of silicone rubber sealant to joint formed at oil pan and cylinder block. Install suitable centering tool (J-23042) in front cover seal. **NOTE** — Centering tool must be used so torsional damper installation will not damage seal and seal is positioned evenly around balancer. Install front cover to block. Install oil pan-to-cover bolts finger tight. Install front cover bolts and tighten all bolts.

FRONT COVER OIL SEAL

Removal — With front cover removed, pry old seal out of cover front. If cover is on engine, remove torsional damper and pry old seal from cover.

Installation — Install new seal with open end towards inside of cover. Drive seal into position with suitable tool. **CAUTION** — If cover is removed from engine, it must be supported at sealing area to prevent cover distortion.

CAMSHAFT			
Engine	Journal Diam.	Clearance	Lobe Lift
250"	1.8677-1.8697"	.0007-.0027"	.2315"①

① — Chevrolet intake lobe lift is .2217".

TIMING GEARS

With valve timing marks lined up (see illustration), check backlash between timing gears with a dial indicator. Backlash should be .004" to .006". If not within specifications and gear replacement is necessary, proceed as follows:

Removal — Remove camshaft from engine and press shaft out of gear using suitable gear remover (J-971). **CAUTION** — Thrust plate must be positioned so Woodruff key in shaft does not damage it when shaft is pressed out of gear. Support hub of gear to prevent damage. Use suitable puller (J-8105) to remove crankshaft gear.

Installation — Support camshaft at back of front journal in a arbor press. Place gear spacer ring and thrust plate over end of shaft. Install Woodruff key in shaft keyway. Install gear and press onto shaft until it bottoms against gear spacer ring. End clearance of thrust plate must be .001-.005". Install crankshaft gear. Install camshaft assembly into block, turning crankshaft and camshaft to line up timing marks.

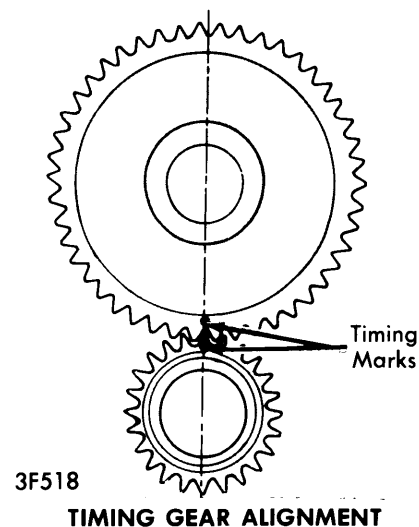

250" 6 CYL. (Cont.)

CAMSHAFT

Removal – With engine removed from vehicle, remove front cover, rocker arm assemblies, push rods, valve lifters and fuel pump assembly. Align timing marks and remove camshaft thrust plate bolts. Remove camshaft and gear as an assembly by pulling out through front of block.

Installation – Install camshaft and gear assembly, being careful not to damage bearings or camshaft. Line up timing marks on timing gears and push camshaft into position. Install bolts and tighten.

CAMSHAFT BEARINGS

If camshaft bearings are scored or if clearance with camshaft journals is excessive, bearings must be replaced. Engine must be removed to remove camshaft bearings. Drive out camshaft plug and remove camshaft bearings using a suitable tool. Install camshaft bearings, using a suitable tool. Make sure camshaft bearing oil holes are aligned with oil holes in cylinder block. Drive in new camshaft plug. Edge of plug should be $\frac{1}{32}$ " below surface of block.

CAMSHAFT END THRUST

End play is taken by thrust plate between camshaft sprocket and front bearing journal. End play should be .001-.005".

CAMSHAFT LOBE LIFT

With valve cover, rocker arms and balls removed from cylinder head, proceed as follows:

1) Using suitable clamping or mounting fixture, attach dial indicator to rocker arm stud so indicator probe rests on top of push rod with indicator and probe in a vertical position over push rod.

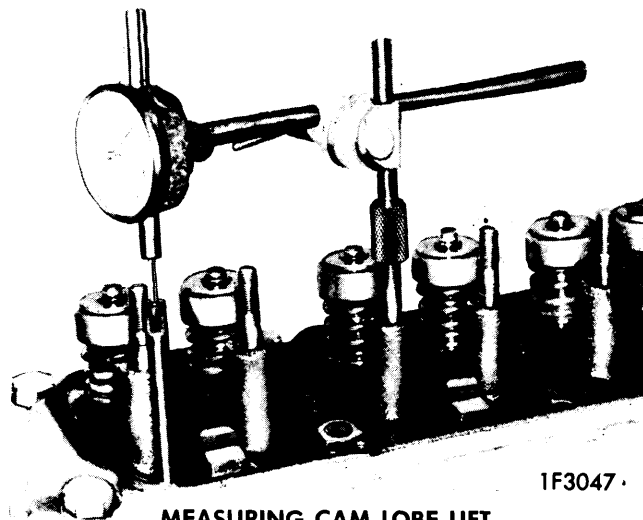

MEASURING CAM LOBE LIFT

2) Rotate crankshaft slowly in direction of engine rotation or, using an auxiliary starter switch, "bump" engine until valve lifter is on heel of cam lobe. At this point, push rod will be at its lowest point. **CAUTION** – If using an auxiliary starter switch, distributor battery ("BAT") lead must be disconnected.

3) With push rod at lowest position, "zero" dial indicator. "Bump" engine over until push rod is in fully raised position. Compare total lift with specifications. Continue to rotate crankshaft until indicator reads zero (checks accuracy of original indicator reading). Check all remaining lobes of camshaft in same manner.

ENGINE OILING

Crankcase Capacity – 4 quarts. Add 1 quart with filter change.

Oil Filter – Replace filter at first oil change, then every second oil change thereafter.

Normal Oil Pressure (Hot) – 36-41 psi @ 2000 RPM.

Oil Pressure Regulator Valve – In oil pump. Not adjustable.

ENGINE OILING SYSTEM

Oil under pressure is directed from oil pump to full flow oil filter. In case filter becomes clogged and restricts full flow of oil, a by-pass valve is located in filter mounting base. From the oil filter, oil flow is directed as follows:

Crankshaft & Camshaft Bearings – Each main and camshaft bearing receives oil from a passage extending through crankcase webs from main oil gallery.

Connecting Rods & Pistons – Oil is delivered from each main bearing to adjacent connecting rod bearing through drilled passages in crankshaft. A hole in connecting rod sprays oil onto cylinder walls for piston and pin lubrication, when holes in rod and journal index.

Valve Lifters – Main oil gallery intersects lifter bores and lifters are supplied with oil directly from main oil gallery. Lifter has metering valve directly below hole in push rod seat to permit oil to pass into hollow push rod.

Rocker Arms & Valve Stems – Oil passes up through hollow push rods to a hole in upper end of push rods that matches hole in rocker arm. Oil sprayed from this hole and across rocker arm lubricates valve stem tip. Oil in rocker arm chamber drains down through push rod holes to valve lifter chamber, then returns to crankcase through drain holes.

Timing Gears – Lubricated by oil flow from a nozzle pressed in front face of block above crankshaft gear. Oil is fed to nozzle through cross-passage from front camshaft bearing.

Distributor Drive Gear – Lubricated by oil drainage from valve lifter compartment.

General Motors 6 Engines

250" 6 CYL. (Cont.)

ENGINE OILING (Cont.)

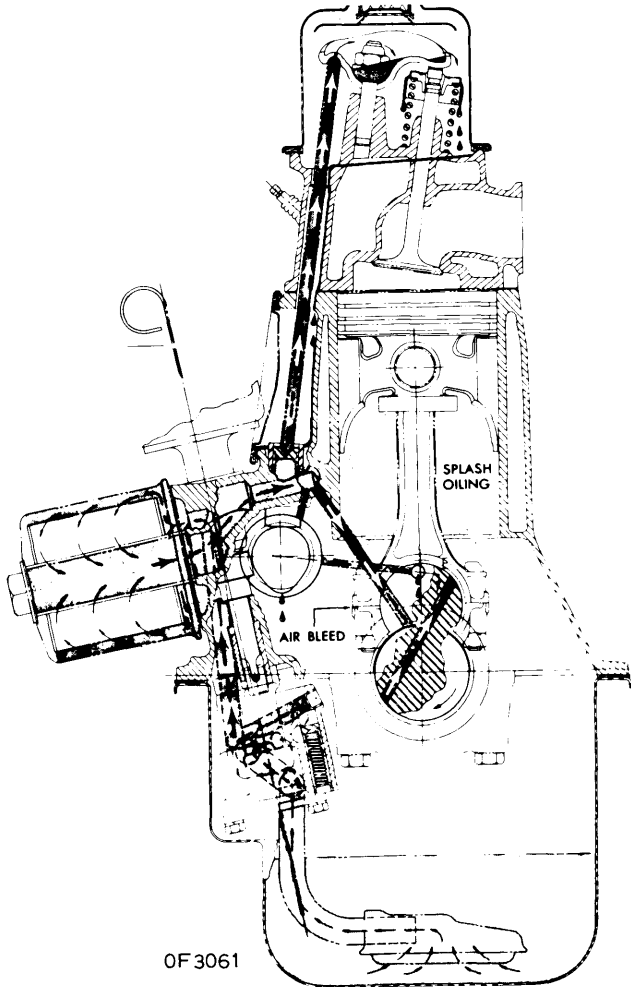

ENGINE OILING SYSTEM

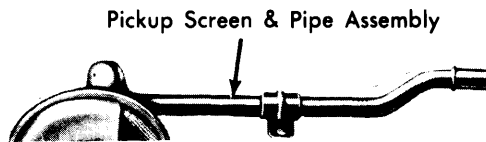
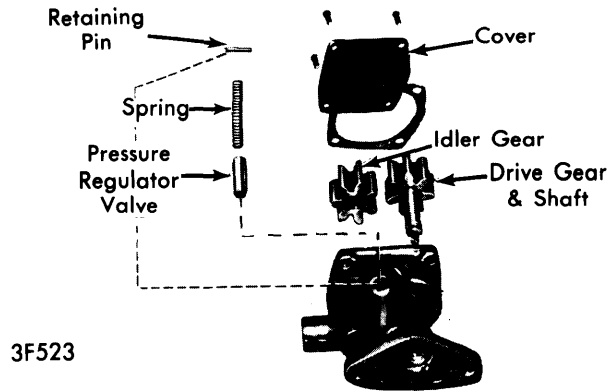

OIL PUMP ASSEMBLY

OIL PUMP

Disassembly — Remove pump cover screws, cover and gasket. Mark gear teeth so they may be reassembled with same teeth indexing and remove idler gear, and drive gear and shaft from pump body. Remove pressure regulator valve retaining pin, regulator valve and related parts. To remove pickup screen and pipe assembly, mount pump in soft-jawed vise and pull pipe from pump. *NOTE* — If pump gears or body are damaged or worn, replace entire pump. Also, pickup screen and pipe are serviced as an assembly only.

Reassembly — To assemble, reverse disassembly procedure using sealer at end of pickup pipe and ensuring that smooth side of idler gear is towards pump cover.

TIGHTENING SPECIFICATIONS

Application	Ft. Lbs.
Cylinder Head	95
Main Bearing Caps	65
Connecting Rod Caps	35
Flywheel	60
Exhaust Manifold⓪	
Inner	20
Outer	30
Water Pump	15
Water Outlet	20
Thermostat Housing	30

Application	Inch Lbs.
Oil Pan	
1/4" Bolts	80
5/16" Bolts	90
Camshaft Thrust Plate	80
Front Engine Cover	80
Oil Pump	115

⓪ — See Exhaust Manifold in this section.