

FORD MOTOR CO. SURE TRACK BRAKE SYSTEM

Continental Mark IV
Lincoln
Mercury
Thunderbird

DESCRIPTION

System is designed to prevent loss of control during emergency or maximum braking conditions. To avoid wheel lockup and resultant skidding with brakes fully applied, system automatically releases and re-applies rear brakes up to four alternating cycles per second. System consists of three major components:

Sensor — Mechanically driven electromagnetic sensor (stator) mounted on rear axle drive pinion bearing retainer housing. Rotor is pressed onto machined outer surface of rear universal joint companion flange outboard of grease seal. When drive shaft rotates, AC voltage impulses generated by sensor are transmitted to control module.

Control Module — Consists of solid state electronic components sealed in a plastic case. Unit is mounted near glove box and is connected to sensor and actuator solenoid. Module receives electrical impulses from sensor and controls operation of actuator as required to prevent rear brake lockup.

Actuator — Mounted on left frame rail near front suspension crossmember. Externally, actuator has five fluid ports, three for power steering fluid and two for hydraulic brake connections. Unit consists of two castings separated by a gasket which divides power steering section (front half) from brake section (rear half). Unit is not serviceable and should be replaced rather than repaired.

OPERATION

AC voltage impulses generated by sensor are transmitted to control module. Module receives signals in form of current and continually monitors drive shaft speed. When signals drop abruptly below pre-determined level due to rapid deceleration (maximum braking), module sends electrical signal to actuator solenoid to release and re-apply rear brakes. Cycle occurs up to four times per second until vehicle speed drops to about six miles per hour or brakes are released by driver.

Actuator (Normal Position) — Solenoid is not energized and solenoid valve spring holds valve against vent port to power steering reservoir. Expansion piston is balanced between power steering pressure and brake pressure, and brake fluid inlet check valve is held open by expansion piston. This allows brake fluid to operate normally on rear brakes.

Actuator (Activated Position) — When electrical signal from control module energizes actuator solenoid, solenoid opens and closes power steering pump fluid pressure port. It also vents support chamber to power steering pump reservoir, resulting in decreased pressure. As pressure decreases, expansion piston is forced forward by brake fluid pressure, closing brake fluid inlet check valve. As piston continues forward, volume of expansion chamber increases, reducing rear brake line pressure and releasing rear brakes. As brakes are released, drive shaft speed increases and module shuts off electrical signal to solenoid. Solenoid valve returns to original position, causing power steering pressure in support chamber to increase, moving piston back and opening brake fluid inlet check valve. This re-applies rear brakes and the cycle can be repeated.

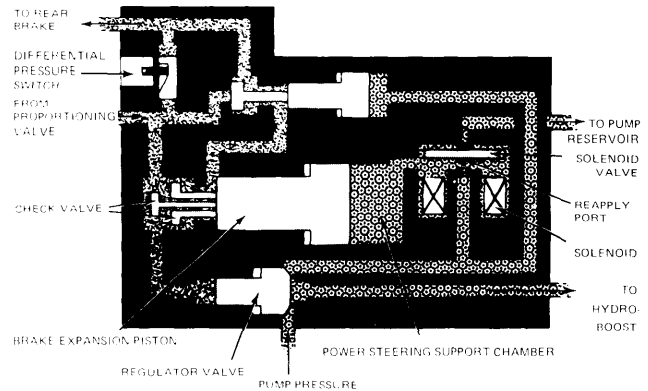

Actuator In Normal Position

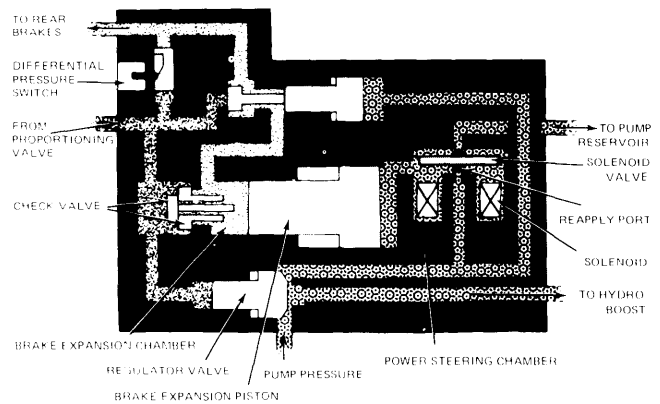

Actuator In Activated Position

5FO01

ACTUATOR SCHEMATIC DIAGRAM

MALFUNCTION INDICATOR

Computer module has ability to detect an open sensor circuit, an open actuator solenoid circuit, an excessively long output pulse to solenoid and an open failure switch connector at actuator. Brake warning light will come on 4-6 seconds after any of the above conditions occur. When this occurs, sure track system becomes inoperative and braking system returns to normal operation. Warning light will also come on immediately after ignition switch is turned to start if sure track fuse is defective or primary power is interrupted.

TESTING

Prior to testing for a possible sure track system failure, ensure that power steering circuit and service brake system is functioning correctly. *NOTE* — A road test should be made *ONLY* when operator is *CERTAIN* that brakes will stop vehicle. A functional test of the system can be performed if a road test is not advisable.

FUNCTION TEST

- 1) Raise rear wheels of vehicle off floor. Start engine, place transmission in drive and bring wheels speed up to 30 MPH.
- 2) Apply brakes quickly and firmly with throttle still applied and observe rear wheels. If system is functioning correctly, it will cycle five or six times or until the brake pedal is released.

FORD MOTOR CO. SURE TRACK BRAKE SYSTEM (Cont.)

ELECTRICAL TESTS

Electrical power is provided to the system when ignition is on. Circuit protection is provided by a four amp. fuse located in fuse panel on Lincoln, Thunderbird and Mark IV models. On Mercury models, fuse is in-line. **CAUTION** — To prevent damage to control module, do not use fuse of higher than four amp. rating (AGA4). The following tests are made using an ohmmeter which must be calibrated to scale being used in each test.

Sensor Test — Remove plug A from module (see illustration). Connect an ohmmeter between pins two and three of connector (see illustration). Resistance should be 2400-3200 ohms. Connect ohmmeter between ground and either connector pin (see illustration). Resistance should be infinite. If resistance is not to specifications, remove connector from sensor at rear axle and repeat resistance checks at terminals of sensor. If resistance is still not to specifications, replace sensor. If resistance is correct at sensor but not at plug, problem is in wiring harness.

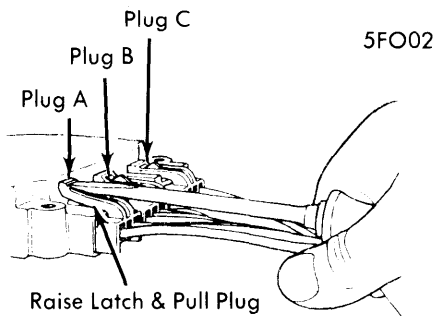

REMOVING PLUG FROM CONTROL MODULE

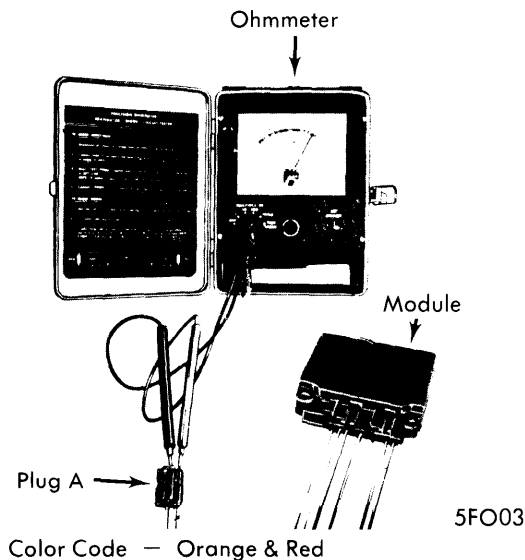

TESTING SENSOR CIRCUIT

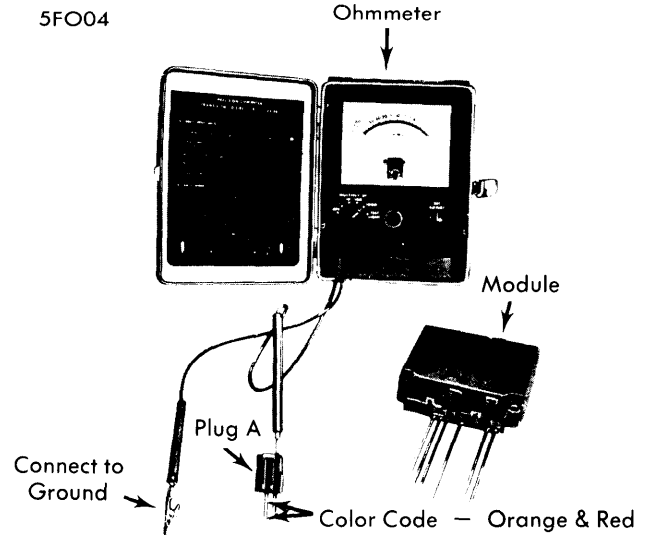

TESTING SENSOR CIRCUIT TO GROUND

Sensor Output Voltage Test — Disconnect plug A at control module and connect an AC voltmeter to pins two and three. Raise rear wheels off ground and run at 30 MPH. Voltage should be above five volts AC.

Solenoid Test — Remove plug B from control module and connect an ohmmeter between pin six and pin four (see illustration). Resistance should be 2-8 ohms. If resistance is lower than two ohms, inspect solenoid wiring from a grounded condition. If resistance is higher than eight ohms, connect ohmmeter to terminals on solenoid. If resistance is between two and eight ohms, inspect wiring for an open or poor connection. If resistance is not to specifications, replace actuator assembly.

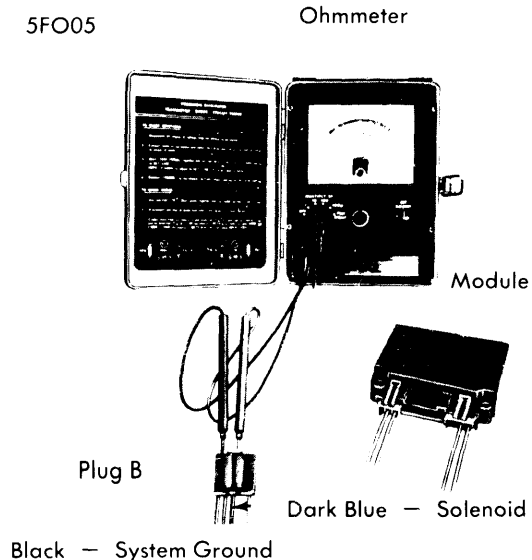

SOLENOID TEST

System Ground Test — Remove plug B from module. Connect an ohmmeter between chassis ground and system ground lead (black) of plug. Resistance should be lower than

Brake Systems

FORD MOTOR CO. SURE TRACK BRAKE SYSTEM (Cont.)

one ohm. If resistance is higher, check system ground wiring for a loose or broken wire and repair as necessary.

Failure Switch Test — Remove plug B from module. Connect ohmmeter between pin five (dark green) and pin eight (red) and check that resistance is less than one ohm (see illustration). Connect ohmmeter between either of the pins and ground. Resistance should be infinite. If resistance is not to specifications, check the intermediate connector in engine compartment and failure switch connector at actuator. If connections are all right, check for continuity in wiring harness

between failure switch connector and connector B at module. If continuity is correct and failure switch has not been shuttled due to brake release during system cycling, replace actuator.

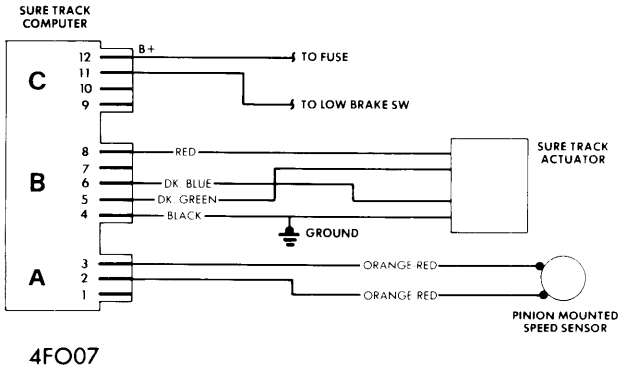

4FO07

FORD SURE TRACK WIRING DIAGRAM

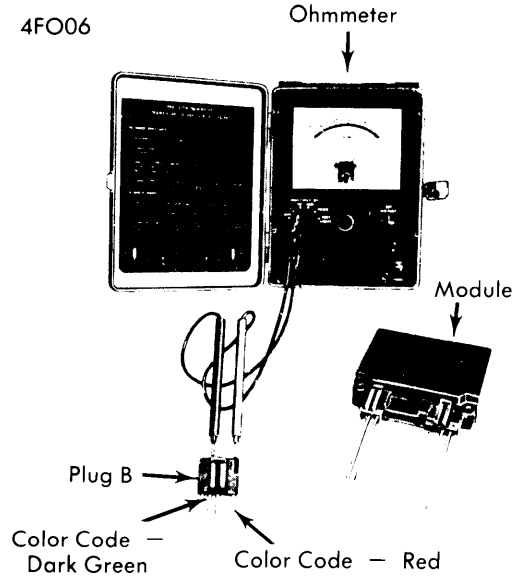

Color Code — Dark Green

Color Code — Red

FAILURE SWITCH TEST