

# Steering Wheel & Column Switches<sup>13-7</sup>

## FORD (Cont.)

plug and guiding switch and connector plug through opening in shaft socket.

3) On fixed column "E" models with automatic transmission, remove shift indicator lamp assembly from shift socket and guide out with switch. To install, reverse removal procedure.

4) On tilt column models, disconnect connector plug from wiring connector by using a wire terminal removal tool. See Fig. 1. Record color code and location of each wire as it is removed.

5) Guide switch assembly out of column through shift socket hole. On "E" models with automatic transmission, disconnect lamp wire from turn signal switch harness before removing switch. To install, reverse removal procedure.

### IGNITION LOCK CYLINDER

1) Disconnect battery ground cable. On non-tilt column models, remove horn pad and steering wheel as previously outlined. Place automatic transmissions in "Park", or manual transmission in "Neutral".

2) Turn lock cylinder to "ON" position. Insert a 1/8" diameter pin or punch in the hole located inside the column near base of lock cylinder housing on standard

column models, or in the hole located on the column housing adjacent to the hazard flasher button on the tilt column models.

3) On all models, depress retaining pin with punch and pull on lock cylinder to remove it. To install, reverse removal procedures.

**Fig. 1: Removing Wires from Connector Using Wire Terminal Removal Tool**

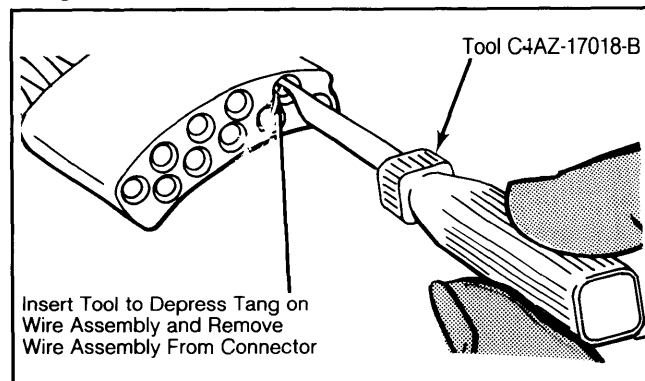

## GENERAL MOTORS

### Chevrolet, GMC

## REMOVAL & INSTALLATION

### STEERING WHEEL

#### Removal ("G" & "P" Models)

Disconnect battery. Remove horn button or pad, receiving cup, Belleville spring, and bushing. Mark steering wheel-to-shaft relationship. Remove snap ring from steering shaft, then remove nut and washer. Use steering wheel puller (J-2927) to remove steering wheel.

**Fig. 1: Removing Steering Wheel Using Puller**

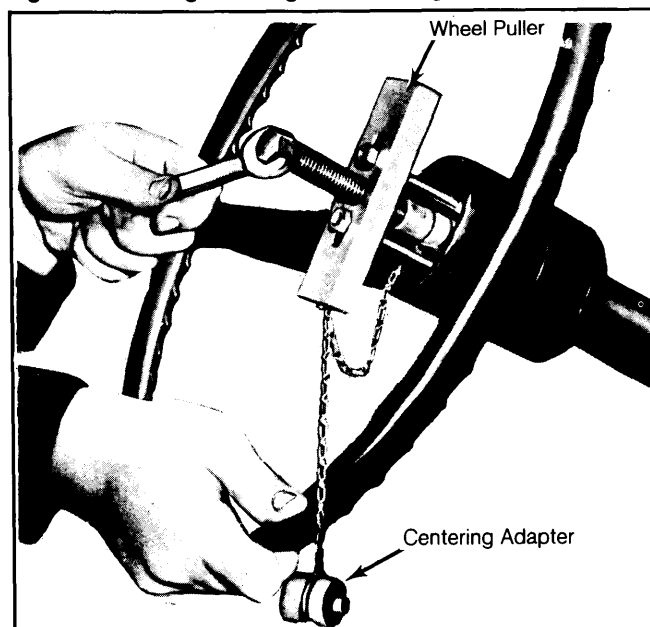

#### Installation ("G" & "P" Models)

To install steering wheel, reverse removal procedure while noting the following: Directional signal switch must be in neutral position while installing steering wheel to prevent damage to cancelling cam and switch assembly. Install snap ring after steering wheel retaining nut has been tightened.

#### Removal ("C" & "K" Models)

Disconnect battery. Remove horn button. Remove snap ring from steering shaft then remove nut and washer. Use steering wheel puller to remove steering wheel. Do not hammer on puller to remove wheel.

#### Installation ("C" & "K" Models)

To install, reverse removal procedures while noting the following: Directional signal switch must be in neutral position while installing wheel to prevent damage to cancelling cam and switch. Install snap ring after steering wheel retaining nut has been tightened.

### DIRECTIONAL SIGNAL SWITCH

#### "G" & "P" Models

1) Remove steering wheel, signal switch cancelling cam and spring. Remove column-to-panel trim plate if present. Disconnect signal switch wiring harness at half-moon connector. Pry wiring harness protector out of column retaining slots.

2) Mark location of each wire in half-moon connector, then remove each individual wire from connector using suitable tool (J-22727). Insert tool into connector, then push in until tool bottoms.

3) Remove tool and pull wire from connector. Remove directional signal lever screw and remove lever. Push in on hazard warning knob and unscrew to remove knob.

4) On Tilt Columns only, remove automatic transmission selector dial screws (if equipped) and remove dial and indicator. Remove cap and dial illumina-

# 13-8 Steering Wheel & Column Switches

## GENERAL MOTORS (Cont.)

tion light from housing cover. Unscrew and remove tilt release lever.

5) Use puller (J-22708) to remove signal housing cover. On all models, remove 3 signal switch mounting screws. Carefully remove switch assembly from column while guiding wire harness through opening in shift lever housing.

**Fig. 2: Pulling Directional Signal Housing Cover**

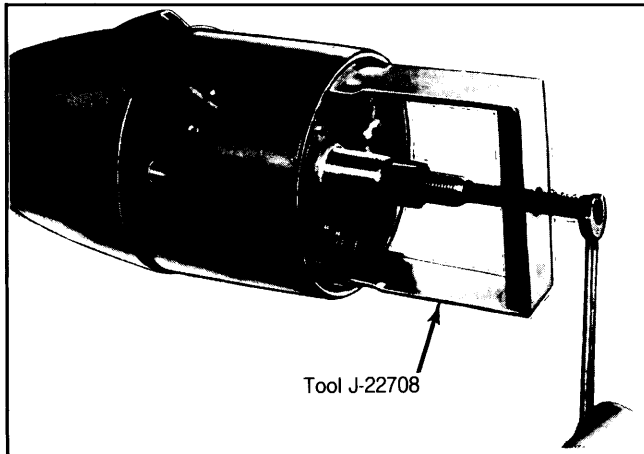

*Tilt column models only.*

6) To install switch, proceed as follows: Wrap ends of signal switch wires with tape and guide them through the opening at lower left side of bearing housing (Tilt Column), out the lower end of shift lever housing and under dash seal.

**CAUTION: It is extremely important that only specified screws, bolts and nuts be used during reassembly. Use of overlength screws could prevent a portion of column from compressing under impact.**

7) Place directional signal switch in mounting position and install screws. Torque screws to 25 INCH lbs. (2.8 N.m). With Tilt Columns align openings in signal switch cover with proper lever positions and tap cover into place. Install tilt release lever. Install automatic transmission selector dial, pointer, dial illumination light and cap (if equipped).

8) On all models, install signal switch lever and hazard warning knob. Bend wire harness connector tabs out of each wire before installing in half moon connector. Install each wire in its marked position and reconnect signal switch harness.

9) Snap wire harness protector into column retaining slots and install signal cancelling cam and spring. Install steering wheel and column-to-instrument panel trim plate (if equipped).

### "C" & "K" Models

1) Remove steering wheel and column-to-instrument panel trim cover. Place screwdriver blade into cover slot and pry up and out to free cover from lock plate. Remove lock plate using suitable compressing tool (J-23653).

2) Screw center post of tool onto steering shaft as far as it will go. Compress lock plate by turning center post nut clockwise. Pry the round wire snap ring out of shaft groove and discard ring. Remove tool and lift lock plate from housing.

**CAUTION: If column is being disassembled on bench, be sure that steering shaft does not slide out of lower end of mast jacket.**

**Fig. 3: Depressing Lock Plate for Snap Ring Removal**

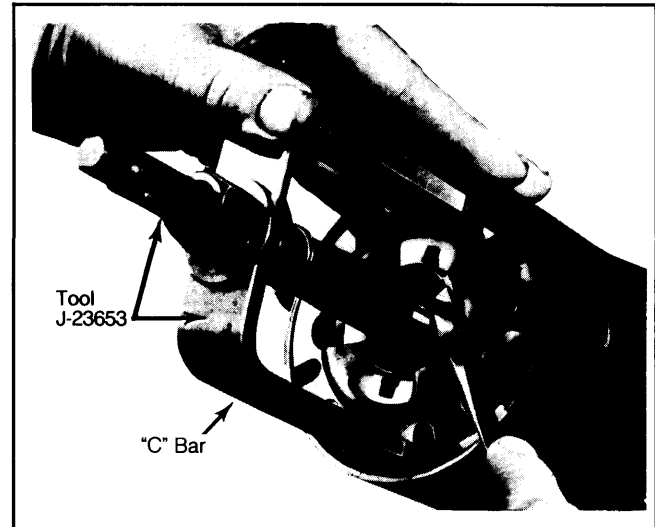

3) Slide directional signal canceling cam, upper bearing preload spring and thrust washer off shaft end. Remove signal switch lever screw and lever. Push hazard warning knob in and unscrew knob.

4) On standard columns remove 3 switch mounting screws. Pull the switch connector out of bracket on jacket and feed switch connector through column support bracket and pull switch straight up, guiding the wiring harness through column housing and protector. Remove wire protector by pulling downward out of column with pliers on tab.

5) On tilt column, position directional signal and shifter housing in "low" position. Remove harness cover by pulling toward the lower end of the column, being careful not to damage wires. Remove 3 switch mounting screws and pull the switch straight up, guiding wiring harness and cover through column housing.

**Fig. 4: Pulling Directional Signal Switch from Housing**

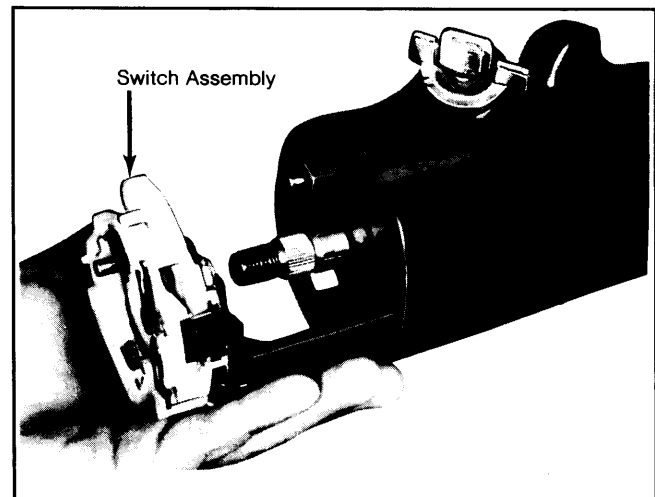

# Steering Wheel & Column Switches <sup>13-9</sup>

## GENERAL MOTORS (Cont.)

6) To install switch, proceed as follows: Feed wire harness connector and cover down through housing and under mounting bracket. With all columns except Tilt type, check that wire harness is in protector. With Tilt columns, install cover on harness. Install switch mounting screws and clip connector to bracket on column jacket.

7) Install trim plate, hazard warning knob and signal lever. Position directional switch in neutral position and pull warning knob out. Slide thrust washer, upper bearing preload spring and canceling cam onto upper end of shaft.

8) Place lock plate over shaft and attach lock plate compressing tool bolt on shaft. Install a new snap ring over tool bolt, place "C" bar of tool over bolt and compress lock plate by turning tool nut. Slide new snap ring down tool bolt and into shaft groove. Install cover on lock plate and snap into place. Install steering wheel and horn button.

**Fig. 5: Installing Lock Plate Snap Ring**

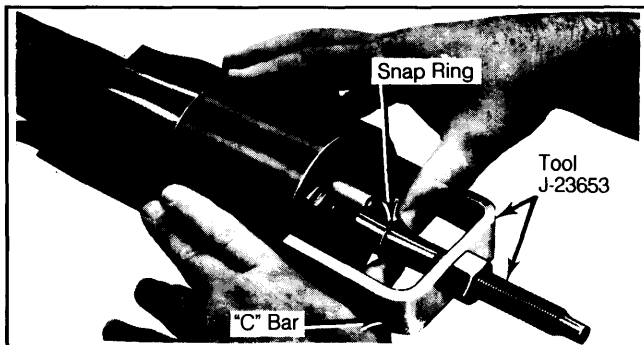

Always use a new snap ring during reassembly.

### HAZARD FLASHER SWITCH

Hazard flasher switch is integral with directional signal indicator switch. Combination is removed or installed as an assembly. See *Directional Signal Switch in this Section*.

### STEERING COLUMN LOCK

1) Place key in lock cylinder and rotate to "RUN" position. Remove steering wheel and lift directional signal switch up far enough to slip over end of shaft. It is not necessary to remove it entirely.

2) Remove lock retaining screw and lock cylinder.

**CAUTION:** If screw is dropped during removal, disassembly of column may be required.

**Fig. 8: Exploded View of Standard Steering Column Hub ("C" and "K" Models Shown)**

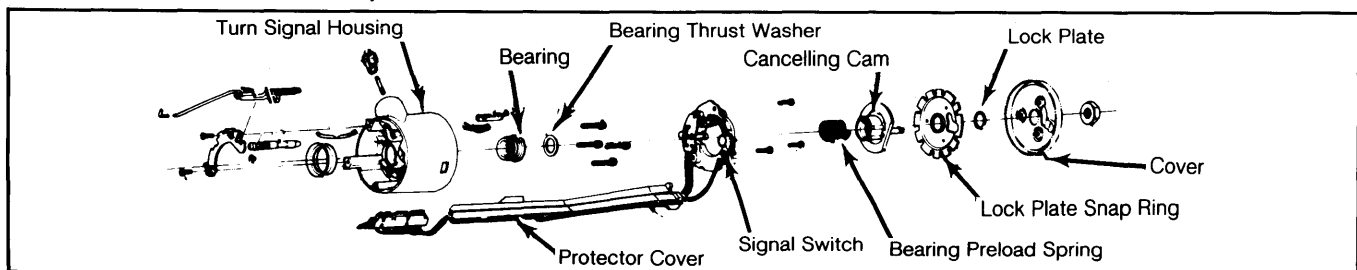

**Fig. 6: Lock Cylinder Assembly**

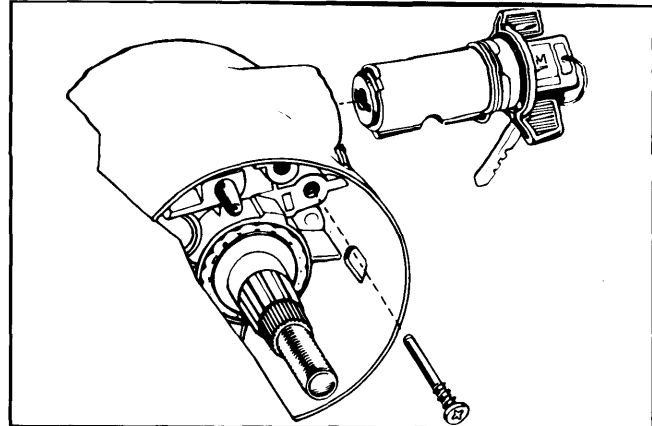

### IGNITION SWITCH

#### "C" & "K" Models

1) To remove ignition switch, steering column must be lowered, but it is not necessary to remove steering wheel. See *Steering Column Removal in this Section*. If steering column is not removed from vehicle, support column before proceeding.

2) Place ignition switch in "LOCK" position. If lock cylinder has already been removed, pull up on actuating rod of switch until it stops, then push down one detent. This will position switch in "LOCK" position. Remove 2 screws, then remove ignition switch.

3) To install, switch and lock cylinder should be in "LOCK" position. With switch in correct position, install activating rod in switch. Install switch on column and tighten mounting screws. Install steering column and check system operation.

**NOTE:** Use only specified screws as overlength screws may prevent a portion of column from compressing under impact.

**Fig. 7: Ignition Switch Assembly with Switch in Lock Position.**

