

FORD MOTOR CO. (Cont.)

DIRECTIONAL SIGNAL SWITCH & HAZARD FLASHER

All Models – 1) Disconnect battery ground cable. Remove horn pad switch and steering wheel as previously outlined. Remove turn signal switch lever by unscrewing from steering column. Disconnect turn signal switch wiring connector by lifting up on tabs and separating.

2) Remove screws securing switch assembly to column. Remove wires and terminals from steering column wiring connector while using a suitable wire terminal removal tool. Record color code and location of each wire as it is removed. Remove protective wire cover from wiring harness and remove switch and wires through top of column. To install, reverse removal procedure.

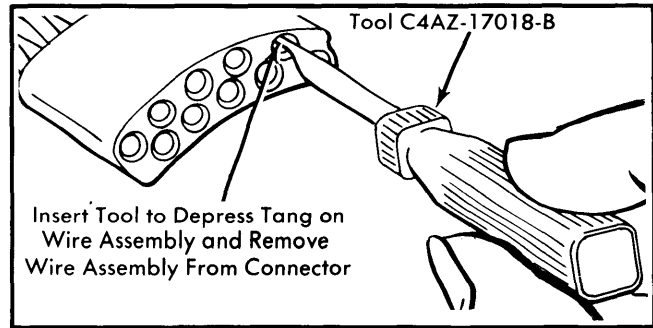

Fig. 2 Removing Wires from Connector Using Wire Terminal Removal Tool

GENERAL MOTORS

Chevrolet
GMC

REMOVAL & INSTALLATION

STEERING WHEEL

Removal ("G" & "P" Models) – Disconnect battery. Remove horn button or pad, receiving cup, Belleville spring, and bushing. Mark steering wheel-to-shaft relationship. Remove snap ring from steering shaft, then remove nut and washer. Use wheel puller to remove steering wheel.

Installation ("G" & "P" Models) – To install steering wheel, reverse removal procedure while noting the following: Directional signal switch must be in neutral position while installing steering wheel to prevent damage to cancelling cam and switch assembly. Install snap ring after steering wheel retaining nut has been tightened.

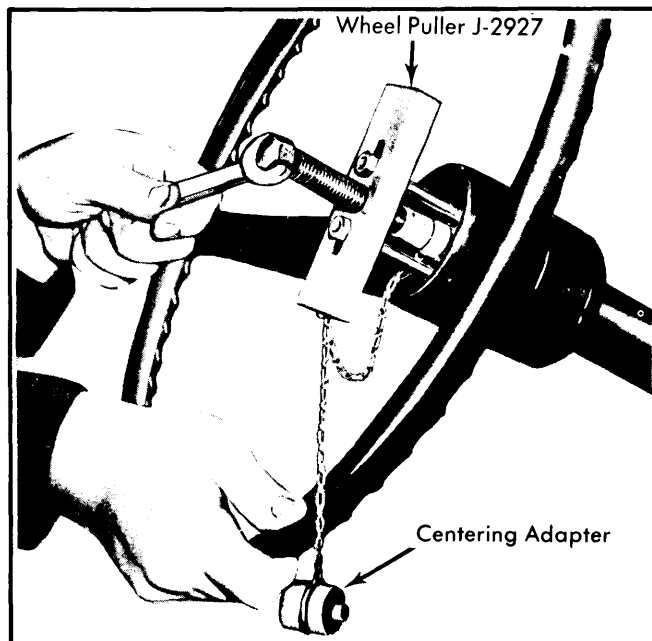

Fig. 3 Removing Steering Wheel using a Puller

Removal ("C", "K", & GMC Motor Home Models) – Disconnect battery. Remove horn shroud or button. Lift steering wheel shroud and horn contact lead from steering wheel.

Remove snap ring from steering shaft, then remove nut and washer. Use steering wheel puller to remove steering wheel. **CAUTION** – Do not hammer on puller while removing wheel.

Installation ("C", "K" & GMC Motor Home Models) – To install, reverse removal procedure while noting the following: Directional signal switch must be in neutral position while installing wheel to prevent damage to cancelling cam and switch. Install snap ring after steering wheel retaining nut has been tightened.

DIRECTIONAL SIGNAL SWITCH

"G" & "P" Models – 1) Remove steering wheel, signal switch cancelling cam and spring. Remove column-to-panel trim plate if present. Disconnect signal switch wiring harness at half-moon connector. Pry wiring harness protector out of column retaining slots. Mark location of each wire in half-moon connector, then remove each individual wire from connector using suitable tool (J-22727). Insert tool into connector, then push in until tool bottoms. Remove tool and pull wire from connector. Remove directional signal lever screw and remove lever. Push in on hazard warning knob and unscrew to remove knob.

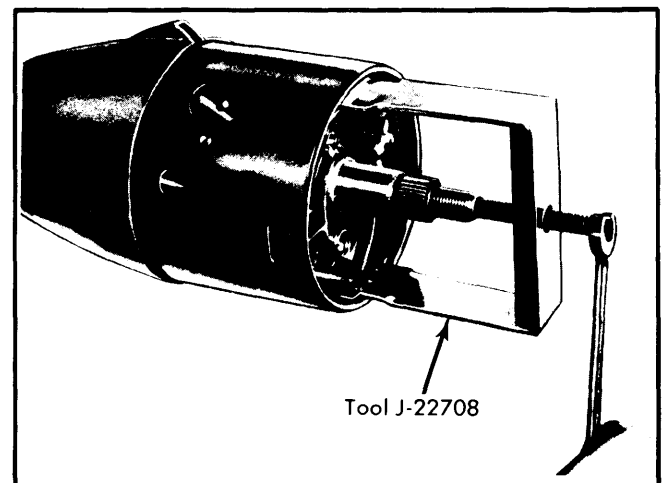

Fig. 4 Pulling Directional Signal Housing Cover for Tilt Column Models

2) On Tilt Columns only, remove automatic transmission selector dial screws (if equipped) and remove dial and indicator. Remove cap and dial illumination light from housing cover.

GENERAL MOTORS (Cont.)

Unscrew and remove tilt release lever. Use suitable puller tool (J-22708) to remove signal housing cover and remove three signal switch mounting screws. Carefully remove switch assembly from column while guiding wire harness through opening in shift lever housing.

3) To install switch, proceed as follows: **CAUTION** — It is extremely important that only specified screws, bolts and nuts be used during reassembly. Use of overlength screws could prevent a portion of column from compressing under impact. Wrap ends of signal switch wires with tape and guide them through the opening at lower left side of bearing housing (Tilt Column) and out the lower end of shift lever housing and under dash seal. Place directional signal switch in mounting position and install screws; torque screws to 25 INCH Lbs. With Tilt Columns, align openings in signal switch cover with proper lever positions and tap cover into place. Install tilt release lever. Install automatic transmission selector dial, pointer, dial illumination light and cap (if equipped).

4) Install signal switch lever and hazard warning knob. Bend wire harness connector tabs out of each wire before installing in half-moon connector. Install each wire in its marked location and reconnect signal switch harness. Snap wire harness protector into column retaining slots and install signal cancelling cam and spring. Install steering wheel and column-to-instrument panel trim plate (if equipped).

"C", "K" & GMC Motor Home Models — 1) Remove steering wheel and column-to-instrument panel trim cover. Remove three cover screws and lift cover off shaft. **NOTE** — Cover screws have plastic retainers on cover back, so it is not necessary to remove screws completely. Remove lock plate using suitable compressing tool (J-23653). Screw center post of tool onto steering shaft as far as it will go. Compress lock plate by turning center post nut clockwise. Pry the round wire snap ring out of shaft groove and discard ring. Remove tool and lift lock plate from housing. **CAUTION** — If column is being disassembled on bench, be sure that steering shaft does not slide out of lower end of mast jacket.

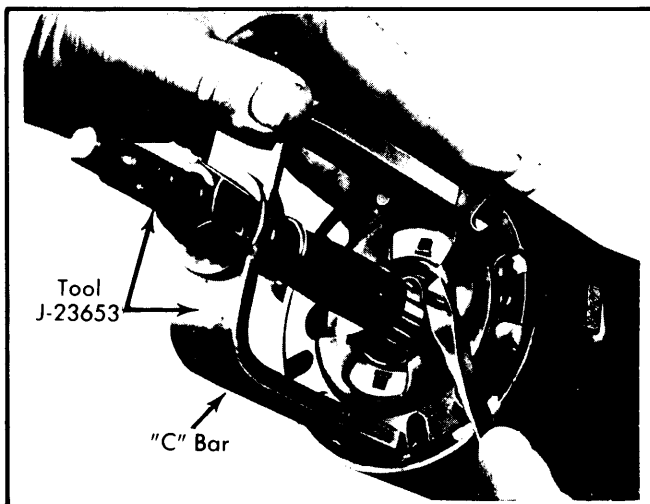

Fig. 5 Depressing Lock Plate for Snap Ring Removal

2) Slide directional signal cancelling cam, upper bearing preload spring and thrust washer off shaft end. Remove signal switch lever screw and lever. Push hazard warning knob in and

unscrew knob. Pull the switch harness connector out of column bracket on jacket, and wrap upper part of connector with tape to prevent snagging wires during switch removal. With Tilt Columns, position directional signal and shifter housing in "L" position. Remove harness cover by pulling toward lower end of column, avoid damage to wires. Remove switch mounting screws and pull switch straight up, guiding wire harness and cover through column housing.

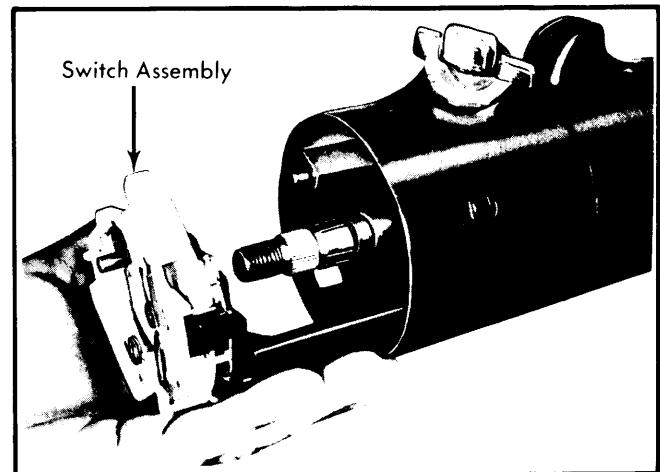

Fig. 6 Pulling Directional Signal Switch from Housing

3) To install switch, proceed as follows: **CAUTION** — It is extremely important that only specified screws, bolts and nuts be used during reassembly. Use of overlength screws could prevent a portion of column from compressing under impact. Feed the wire harness, connector and cover down through housing and under mounting bracket. With all columns except Tilt type, check that wire harness is in protector. With Tilt Columns, install cover on harness. Install switch mounting screws and clip connector to bracket on column jacket. Install trim plate, hazard warning knob and signal lever. Position directional switch in neutral position and pull warning knob out. Slide thrust washer, upper bearing preload spring and cancelling cam onto upper end of shaft.

4) Place lock plate over shaft and attach lock plate compressing tool bolt on shaft. Install a new snap ring over tool bolt, place "C" bar of tool over bolt and compress lock plate by turning tool nut. Slide new snap ring down tool bolt and into shaft groove. **NOTE** — Always use a new snap ring during reassembly. Install cover and screws on end of shaft and install steering wheel and components.

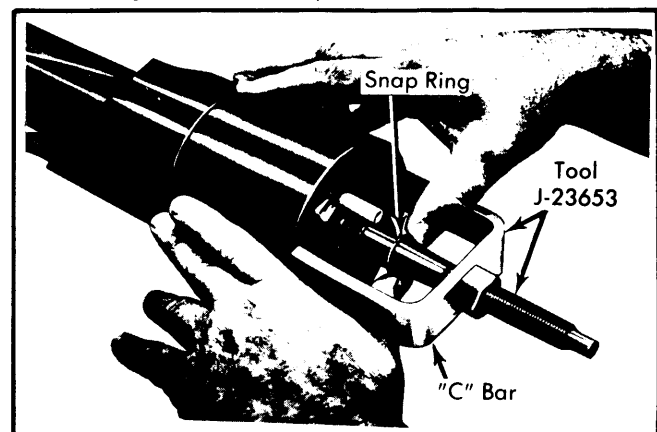

Fig. 7 Installing Lock Plate Snap Ring

GENERAL MOTORS (Cont.)

HAZARD FLASHER SWITCH

All Models — Hazard flasher switch is integral with directional signal indicator switch. Combination is removed or installed as an assembly. See *Directional Signal Switch* in this Section.

STEERING COLUMN LOCK

"C", "K" & GMC Motor Home — 1) Place key in lock cylinder and rotate to "RUN" position. Remove steering wheel and lift directional signal switch up far enough to slip over end of shaft. It is not necessary to remove it entirely.

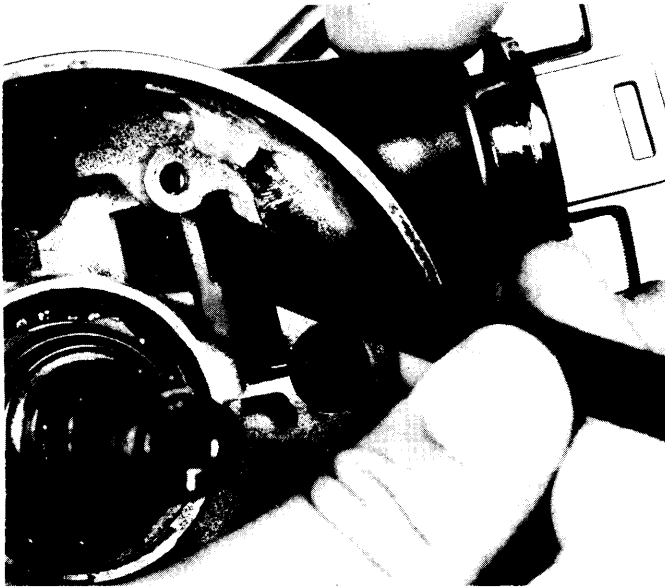

Fig. 8 Depressing Lock Cylinder Spring Latch

2) Insert a small screwdriver into signal housing slot. Pressing tool to right side of slot, and at same time, depress spring latch at lower end of lock cylinder. With latch depressed, lock cylinder can be removed from housing.

3) To install lock cylinder, hold cylinder sleeve and rotate knob clockwise against stop. Insert cylinder into housing bore with key on cylinder sleeve aligned with keyway in housing. Push cylinder into abutment of cylinder and sector. Hold a .070" drill between lock bezel and housing. Rotate cylinder counterclockwise, maintaining a light pressure until drive of cylinder mates with sector. Push in until snap ring pops into groove and cylinder is set in place. Remove drill and check lock for freedom of rotation. Install directional signal switch and steering wheel components.

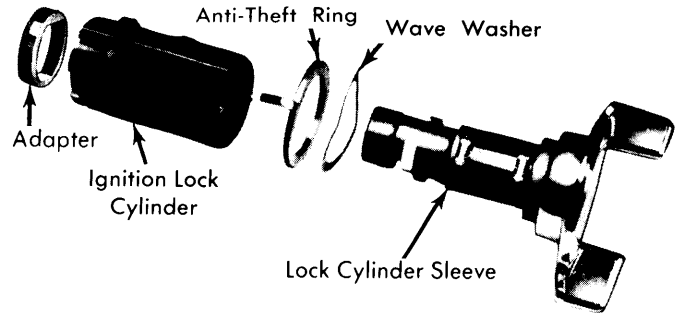

Fig. 9 Disassembled Lock Cylinder Assembly

IGNITION SWITCH

"C", "K" & GMC Motor Home Models — 1) To remove ignition switch, steering column must be lowered, but it is not necessary to remove steering wheel. See *Steering Column Removal* in this Section. If steering is not removed from vehicle, support column before proceeding.

2) Place ignition switch in "LOCK" position ("C" and "K" models) or "ACC" position (GMC Motor Home). If lock cylinder has already been removed, pull up on actuating rod of switch until it stops, then push down one detent ("C" and "K" models) or leave in position when stopped (GMC Motor Home). This will position switch in "LOCK" or "ACC" position. Remove two screws, then remove ignition switch.

3) To install, switch and lock cylinder should be in "LOCK" ("C" and "K" models) or "ACC" (GMC Motor Home) position. With switch in correct position, install activating rod in switch and install switch on column, and tighten mounting screws.

NOTE — Use only specified screws as overlength screws may prevent a portion of column from compressing under impact. Install steering column and check system operation.

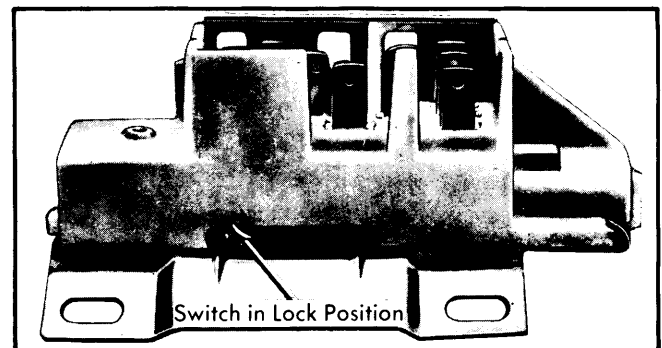

Fig. 10 Ignition Switch Assembly with Switch in Lock Position

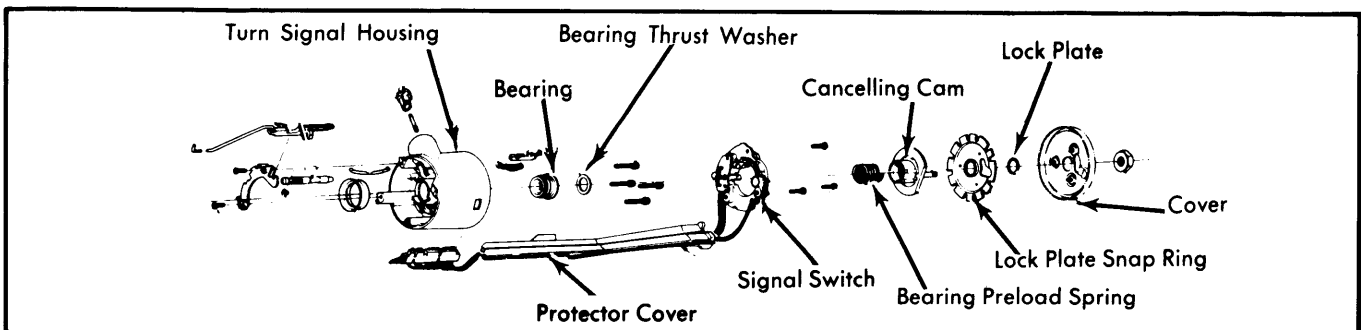

Fig. 11 Exploded View of Standard Steering Column Hub ("C" and "K" Models Shown)